

C524, C524i Elliptical Fitness Crosstrainer

Warning: This service manual is for use by Precor trained service providers only. If you are not a Precor Trained Servicer, you must not attempt to service any Precor Product; Call your dealer for service.

This document contains information required to perform the majority of troubleshooting, and replacement procedures required to repair and maintain this product.

This document contains general product information, software diagnostic procedures (when available), preventative maintenance procedures, inspection and adjustment procedures, troubleshooting procedures, replacement procedures and electrical block and wiring diagrams.

To move directly to a procedure, click the appropriate procedure in the bookmark section to the left of this page. You may “drag” the separator bar between this page and the bookmark section to change the size of the page being viewed.

Section One - Things You Should Know

Right, Left, Front, and Back Conventions

In this manual, right, left, front, and back are from the perspective of a user standing on the EFX, facing the display enclosure.

General System Information

- The ramp operating system has a battery monitoring system. If the battery voltage falls below 11 Vdc when ramp movement is initiated or the battery voltage falls below 10 Vdc after ramp movement has been initiated, ramp movement will be stopped and the message “**NO RAMP LOW VOLTAGE**” will be displayed. Ramp motion will not be enabled until such time as the battery voltage exceeds the above limits.
- The generator performs three functions in the EFX. First, by controlling the amount of electrical load applied to the generator, the user’s pedalling resistance is controlled. Second, the generator is used to charge the EFX’s internal battery. Lastly, one of the generators three phase output windings is monitored to determine when the unit is in use and when it is idle. This system also determines the stride rate by determining the operating speed (output frequency) of the monitored generator winding.

Warning and Caution Statements and General Safety Guidelines

Warning statements indicate a particularly dangerous activity. Warning statements you will find in this manual include:

- If the EFX has been in recent use, the load resistors and load resistor mounting bracket may be extremely hot.
- Because this is a self powered unit, it will either be necessary to either equip the unit with the optional external power supply or have an assistant pedal on the unit while voltage measurements are being taken. Because of the danger of working on the unit while it is in motion using the optional external power supply is strongly recommended.
- When the unit is used, stairarms are in motion, the generator will operate and produce potentially hazardous voltages even when the battery is disconnected.
- To remove power from the EFX, the optional external power supply (when equipped) must be disconnected from the wall outlet and the red (positive) lead must be disconnected from the battery. Always ensure that the EFX external power supply is unplugged from the wall outlet and the red (positive) lead is removed from the battery when you inspect or adjust the EFX, or when you isolate, remove, or replace an EFX component.

- Removing the covers exposes high voltage components and potentially dangerous machinery. Exercise extreme caution when you perform maintenance procedures with the cover(s) removed.
- During service operations you will be very close to moving machinery and voltage bearing components. When you perform maintenance procedures with the covers removed, remove jewelry (especially from ears and neck), tie up long hair, remove neck ties, and do not wear loose clothing.
- Exercise caution when touching any wire or electrical component during EFX operation.
- A pinching hazard exists when the unit is operated by turning the crankarms by hand. It is possible to seriously pinch a finger between the crankarm and stairarm. The stairarms should be removed before operating the crankarms by hand.
- Caution statements are intended to prevent damage to the EFX as a result of the current activity. Caution statements included in this manual are listed below:
- When it is necessary to lift or move the EFX, ensure that the EFX has adequate support and that you use proper lifting techniques.

Safety guidelines you should know and follow include:

- Read the owner's manual and follow all operating instructions.
- Operate the EFX on a solid, level surface.
- Visually check the EFX before beginning service or maintenance operations. If it is not completely assembled or is damaged in any way, exercise extreme caution while operating and checking the EFX.
- When operating the EFX, do not wear loose clothing. Do not wear shoes with heels or leather soles. Check the soles of your shoes and remove any embedded stones. Tie long hair back.
- Do not rock the unit. Do not stand or climb on the handlebars, display enclosure, or cover.
- Do not set anything on the handlebars, display enclosure, or cover. Never place liquids on any part of the EFX, while performing service.
- To prevent electrical shock, keep all electrical components away from water and other liquids.
- Do not use accessory attachments that are not recommended by the manufacturer-such attachments might cause injuries.

General Information

For the latest exploded view, part number and part pricing information, visit the Precor dealer website at "www.precor.com/connection".

Tools Required

Multimeter	Allen wrench set
Anti-static kit	Screwdriver set
4" - 6" gear puller	7/16" allen key, socket wrench mounted
Precor part number 20030-108 belt gauge	Straight edge
US and metric end wrench set	
US and metric socket wrench set	
Torque wrench, 200 in./lbs.	
Torque wrench, 200 ft./lbs	

Section Two - Preventive Maintenance

Preventive maintenance measures are either scheduled or unscheduled. Scheduled preventive maintenance activities are included here so that you are aware of preventive measures performed on a regular basis.

Regular Preventive Maintenance (Owner)

Cleanliness of the EFX and its operating environment will keep maintenance problems and service calls to a minimum. Precor recommends that you perform the following preventive maintenance schedule.

After Each Use

- Unplug the optional external power supply (when equipped) from the AC outlet.
- Wipe down the covers, handlebars, stairarm wheels and stairarm ramps with a damp cloth.

Daily Maintenance

Clean the EFX's frame, covers, stairarms, stairarm ramps and stairarm wheels using water or a 30:1 solution of Simple Green[®] and water. Wipe the surface of the electronic console with a damp sponge or soft cloth. Dry with a clean towel. A 30:1 solution of Simple Green[®] and water is the only cleaning solution that has been tested and approved for use on the C524 or C524i ramps. Use of any other cleaner, may cause degradation of the ramp anodizing and void the ramp warranty. The use of an acid (citric) based cleaner will cause ramp anodizing damage and is not authorized by Precor.

Weekly Maintenance

- Vacuum underneath the EFX, following these steps:
 1. Unplug the optional external power supply (when equipped) from the AC outlet.
 2. Place the EFX on its side.

Note:

Place a drop cloth under the EFX to protect the flooring and to ensure that the EFX handrail is not scratched or damaged.

3. Vacuum the rug or damp mop the floor.
4. Make sure that the floor is dry before returning the EFX to an upright position.

Quarterly Maintenance

1. Remove the rear covers.
2. Check the step up and input belt alignment and tension as in Procedure 5.3.
3. Replace the rear cover.

On-Site Preventive Maintenance (Service Technician)

When you are called to service a EFX, perform these preventive maintenance activities:

- Perform the software diagnostics. Check LED and keypad function. Record the odometer reading.
- Check speed sensor function (is the stride rate displayed when the unit is in operation?). If not, see Procedure 6.3 (C524) or Procedure 6.4 (C524i).
- Visually inspect the drive belts for cracks, fraying or excessive wear.
- When furnished, inspect the optional power supply cords. If a power supply cord is damaged, install a new power supply.
- Visually examine all wires and check connectors and wire connections. Secure connections and replace wiring as necessary.

Procedure 3.1 - Software Access Codes

The C524 and C524i use the standard access codes to provide access to the various software features. In using the standardized access codes the keys are hypothetically numbered left to right with key #1 on the far left and key #7 on the far right. The standard access codes use all sequential key presses. The allowable delay between key presses is short. If too much time is taken between key presses the access procedure will be aborted. If the access is aborted, it will be necessary to start over from the beginning. See Diagram 3.1. On the C524 display key #1 is the **CROSS RAMP ▲** key and key #4 is the **RESET** key.

Standard Access Codes

Diagnostics
 Odometer
 Club Settings

Keys **RESET**,5,1,7,6,5,7,6,1
 Keys **RESET**,6,5
 Keys **RESET**,5,6,5,1,5,6,5

Diagram 3.1 - Display Panel



Procedure 3.2 - Accessing the Diagnostic Program

The EFX diagnostic software cycles through the following tests:

- Display Test
- Keyboard Test
- Heart Rate Test
- Battery Test
- RPM Test
- Lift Test
- Brake Test

Procedure

1. Start pedalling and continue to pedal as you perform step 2.
2. With the **PRECOR** banner scrolling, press keys **RESET,5,1,7,6,5,7,6,1.**, sequentially.
3. The message **HARDWARE VALIDATION** will be displayed for a few seconds.
4. The message **DISPLAY TEST** will be displayed followed by every LED on the display being illuminated. Check each LED segment to ensure that all of the segments are illuminated. Press the **ENTER** key to advance to the keyboard test.
5. The message **KEYBOARD TEST** will be displayed followed by a graphical representation of each key position on the display housing. As each key on the display is pressed the key representation is turned "off", indicating that the key is functioning. Check each key in this manner, including the numeric keyboard. Press and hold the **ENTER** key for 2 seconds to advance to the heart rate test.
6. The message **HEART RATE TEST** will be displayed followed by the unfiltered (U), filtered (F) and polar (P) heart rate readings if the heart rate option is installed in the EFX and a chest strap transmitter or a test transmitter is being used. If the heart rate option is not installed in the EFX the message **NO HEART RATE RECEIVER** will be displayed instead of the heart rate readings. Press the **ENTER** key to advance to the brake test.
7. The message **BATTERY TEST** will be displayed followed by the battery voltage. Press the **ENTER** key to advance to the RPM test.
8. The message **RPM TEST** will be displayed followed by the pulse (power bit) reading and the RPM reading. Press the **ENTER** key to advance to the lift test.
9. The message **LIFT TEST** will be displayed followed by the ramp level and A/D (analog to digital) reading. The A/D is the number the system use to track the lift position. The A/D number will be used in the lift calibration portion of this service manual. (Procedure 5.4).

10. The message **BRAKE TEST** will be displayed followed the resistance level and brake level readings. This test allows you to test the brake (resistance) at each resistance level. Press the **ENTER** key to exit the diagnostics program.

Procedure 3.3 - Displaying the Odometer

Procedure

1. Start pedalling and continue to pedal as you perform step 2.
2. With the **PRECOR** banner scrolling, press keys **RESET,6,5**, sequentially.
3. The message **INFORMATION DISPLAY** will be displayed for a few seconds.
4. The message **ODOMETER** will be displayed followed by the total number of strides accumulated. The total number of strides can be converted to miles by dividing by 2241 or to kilometers by dividing by 1392.5. Press the **ENTER** key to advance to total strides.
5. The message **TOTAL STRIDES** will be displayed followed by the total number of strides logged on the EFX. Press the **ENTER** key to advance to hour meter.
6. The message **HOURLY METER** will be displayed followed by the total number of hours that the EFX has been in use. Press the **ENTER** key to advance to software version.
7. The message **SOFTWARE VERSION** will be displayed followed by the software versions of the upper and lower PCA's. For example, **UPPER 1.01 LOWER 1.01**. Press the **ENTER** key to advance to error log.
8. The message **ERROR LOG** will be displayed followed by the error in log position 1. Each log entry shows the log position, the stride count when the error occurred and the hour meter when the error occurred. For example; **1 ER21 123456 STR 45678 HRS**. The error log can record up to ten error conditions. The error code in position one will be the most recent error and the error in position ten will be the oldest error. If more than ten errors have been logged, only the ten most recent will be displayed. When a new error is logged, each existing error is pushed down one position and the error in position 10, if any, is lost. Use the **▼** and **▲** keys to move through the log. Pressing and holding the **QUICK START** key for four seconds will clear the log. Press the **ENTER** key to exit the odometer program.

Procedure 3.4 - Club Settings

1. Start pedalling and continue to pedal as you perform step 2.
2. With the **PRECOR** banner scrolling, press keys **RESET,5,6,5,1,5,6,5**, sequentially.
3. The message **SET CLUB PARAMETERS** will be displayed for a few seconds.
4. The message **SELECT LANGUAGE** will be displayed followed by the currently selected language. Use the ▼ and ▲ keys to select the language preference. Press the **ENTER** key to advance to units of measurement.
5. The message **SELECT UNITS** will be displayed followed by the currently selected unit of measurement. Use the ▼ and ▲ keys to select either **U.S. Standard** or **METRIC** measurements. Press the **ENTER** key to advance to maximum workout time.
6. The message **SET MAX WORKOUT TIME** will be displayed followed by the currently selected maximum workout time. Use the ▼ and ▲ keys to select the maximum workout time. The maximum workout time may be set between 1 and 240 minutes or no limit. Press **ENTER** to advance to maximum pause time.
7. The message **SET MAX PAUSE TIME** will be displayed followed by the currently selected maximum pause time. Use the ▼ and ▲ keys to select the maximum pause time. The maximum pause time is the that will elapse after the pause key has been pressed until the unit resets. The maximum pause time may be set between 1 and 120 seconds. Press **ENTER** to exit the club settings program.

Procedure 3.5 - Documenting Software Problems

When a problem is found with either the software or upper or lower PCA's, record the information listed below. If you isolated the problem to either the PROM, upper PCA, or lower PCA, include the information you recorded with the malfunctioning PROM or PCA when you ship it to Precor.

When a problem occurs, record the following information:

- Model and serial number
- Software version number

Note:

Look at the PROM mounted on the upper PCA. A label on the PROM indicates the software version number.

- User and program number running when the problem occurred
- A description of:
 - a What happened or failed to happen.
 - b The action taken by the user just before the problem occurred.
 - c Problem-related information (such as how far into the program the problem occurred, the work level being used when the problem occurred, etc.).
- The frequency of occurrence.

Section Four - Checking EFX Operation

This section provides you with a quick method of checking EFX operation. Check the operation of the EFX at the end of most maintenance procedures.

Procedure

1. Start striding on the EFX or plug the optional external power supply (when available) into the EFX and the AC outlet.
2. At the **PRECOR** banner, press **QUICK START**.
3. Select Resistance Level 1 and press **ENTER**.
4. Operate the EFX for 4–5 minutes. As you operate the EFX, concentrate on the operating sounds made by the unit. Be on the alert for unusual rubbing, hitting, grinding, or squeaking noises.
5. If the EFX makes unusual noises or the electronic display does not change appropriately, troubleshoot per Section 6.
6. Press the **RESISTANCE ▲** key until you reach Resistance Level 10. Operate the EFX for another 2–3 minutes.
7. If the EFX resistance does not change or the operation of the EFX feels inconsistent compared with Resistance Level 1, troubleshoot per Section 6.
8. Press the **RESISTANCE ▲** key until you reach Resistance Level 20. Operate the EFX for another 2–3 minutes.
9. If the resistance of the EFX does not change or the EFX operation feels inconsistent with Resistance Levels 1 and 10, troubleshoot per Section 6.
10. Check the LED's mounted on the upper PCA and the function keys displayed on the electronic console by performing Procedure 3.2.
11. Press the **CROSSRAMP ▲** key while viewing the electronic console. Confirm that the foot pads incline and the ramp display increments to 20 as the **CROSSRAMP ▲** key is pressed.
12. Press the **CROSSRAMP ▼** key while viewing the electronic console. Confirm that the foot pads return to a level position and the ramp display decrements to 1 as the **CROSSRAMP ▼** key is pressed.
13. If the ramp system of the EFX does not operate properly, troubleshoot per Section 6.

Procedure 5.1 - Measuring the Resistance of a Generator (C524, only)

Caution

Remove power from the EFX before you measure generator resistance.

Procedure

1. Remove the rear cover and disconnect the red battery lead from terminal M6 of the lower PCA.

WARNING

Before continuing with this procedure, review the Warning and Caution statements listed in Section One, Things You Should Know.

2. Set the ohmmeter to a range that will conveniently read up to 50 Ω .
3. Remove the three generator output leads from the lower PCA, brown from terminal M3, blue from terminal M4 and violet from terminal M5.
4. With an ohmmeter, read between the brown and blue leads, blue and violet leads and the brown and violet leads removed in step 3. Each of the three readings should be between 26 Ω and 27 Ω . If any of the readings are significantly high or significantly low, replace the generator.

Diagram 5.1 - Lower PCA

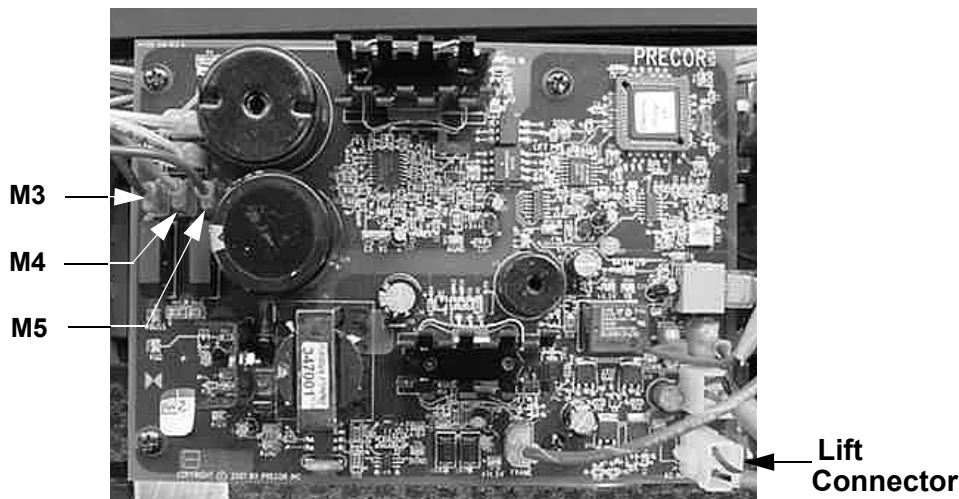

5. Reconnect the generator leads to the lower PCA as follows: violet to M5, blue to M4 and brown to M3.
6. Reconnect the red battery lead to terminal M6 of the lower PCA.

Procedure 5.2 - Measuring the Resistance of a Generator (C524i, only)

Caution

Remove power from the EFX before you measure magnet resistance.

Procedure

1. Remove the rear cover and disconnect the red battery lead from terminal M6 of the lower PCA.

WARNING

Before continuing with this procedure, review the Warning and Caution statements listed in Section One, Things You Should Know.

2. Set the ohmmeter to a range that will conveniently read up to 50 Ω .
3. Remove the six phase generator connector from the lower PCA, refer to Diagram 5.2, below.
4. With an ohmmeter, read between terminals 1 & 2, terminals 1 & 3, terminals 1 & 5, terminals 1 & 6, and terminals 1 & 7 on the six phase generator connector (J1). Each of the six readings should be between 36 Ω and 39 Ω .
5. If any of the readings are significantly high or significantly low, remove the intermediate cable from the generator and perform the same measurements as in step 4 on the generator connector. If the reading are now correct check and or replace the intermediate cable. refer to Diagram 5.4. If the readings are still incorrect, remove the six phase generator.

Diagram 5.2 - Lower PCA

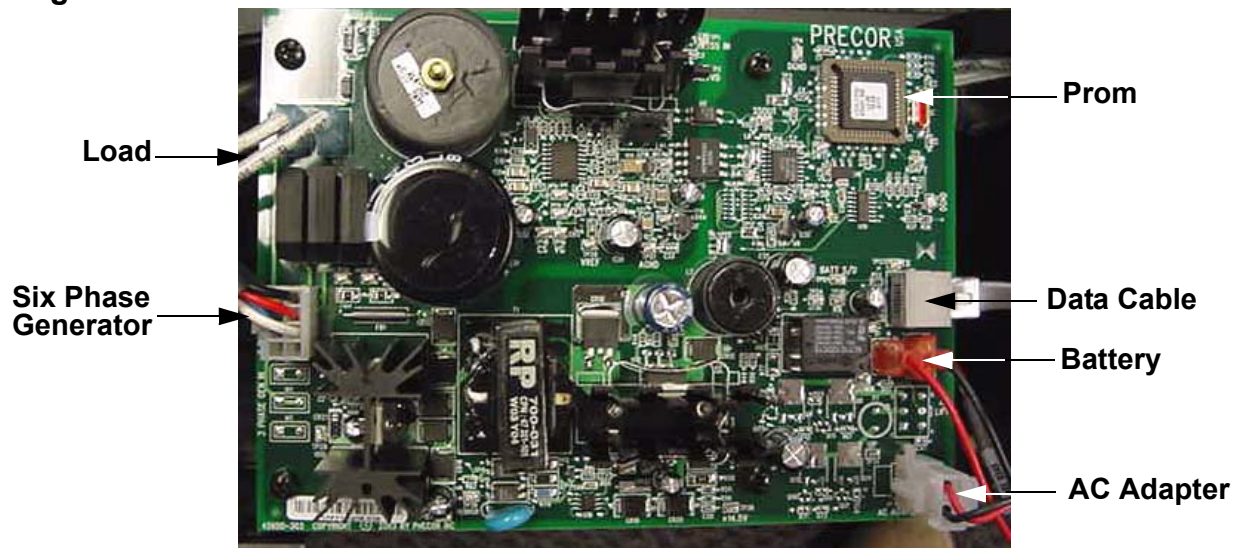

6. Replace the generator per Procedure 7.17. Reconnect the intermediate cable removed in step 5 to the replacement generator and the lower PCA.
7. Reconnect the red battery lead to terminal M6 of the lower PCA.

Procedure 5.3 - Inspecting and Adjusting Belt Tension

Procedure

1. Remove the rear cover and disconnect the red battery lead from terminal M6 of the lower PCA. If you are only inspecting the generator belt tension, skip to step 7.

WARNING

Before continuing with this procedure, review the Warning and Caution statements listed in Section One, Things You Should Know.

WARNING

If the EFX has been in recent use, the load resistors and mounting bracket may be extremely hot.

2. Remove the three screws that fasten the load resistor assembly and shield to the frame upright. Rotate the load resistor assembly 180 degrees and set it on the top of the frame upright.
3. Place a 20030-108 or equivalent belt gauge on the input belt as shown in Diagram 5.2.

Diagram 5.3 - Input Belt Tension Measurement

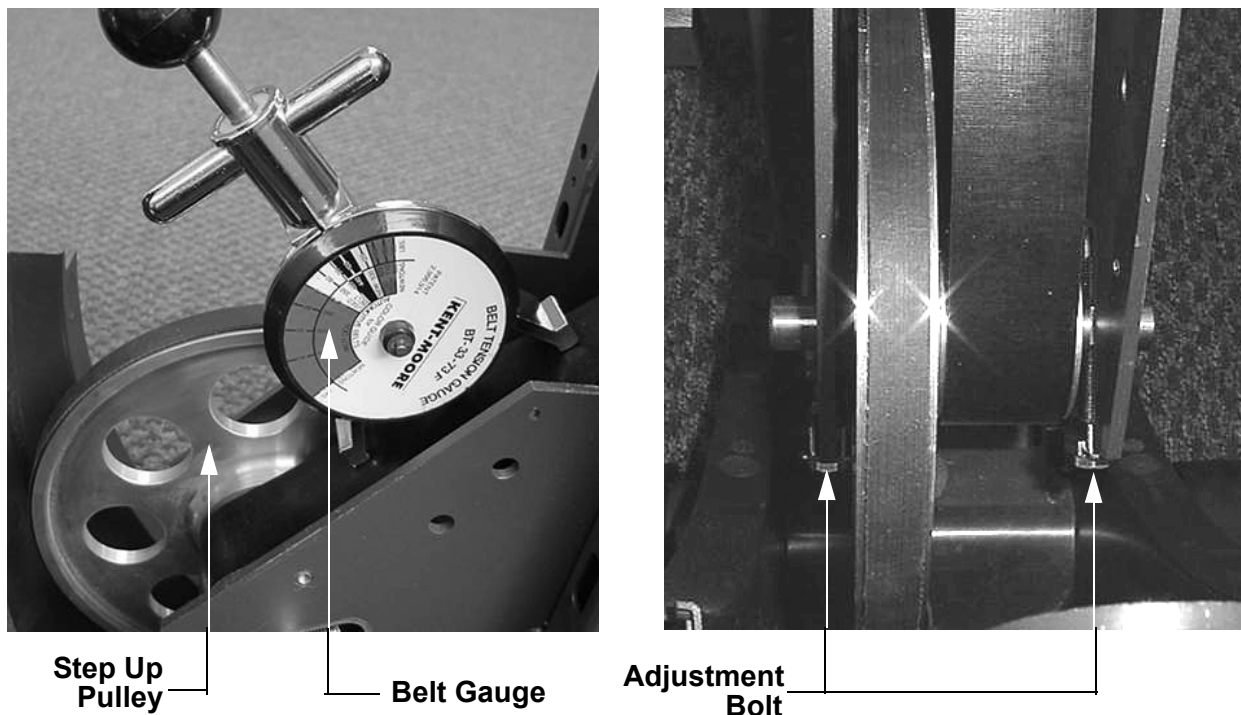

4. The belt gauge should read 100 lbs. If the belt tension is significantly high or low the belt tension may be adjusted using the adjustment bolts shown in Diagram 5.2. To adjust the belt tension first straighten the locking tabs on both bolts. When adjusting the tension, turn

both bolts equal amounts. When the adjustment is complete the step up pulley shaft must remain perpendicular to the frame and drive belt. Turning the adjustment bolts clockwise will increase belt tension, turning the adjustment bolts counter-clockwise will decrease belt tension.

5. Changing the tension of the input drive belt will also affect the tension of the generator belt. If the input belt tension has been changed, continue with step 7.
6. Place a 20030-108 or equivalent belt gauge on the generator belt as shown in Diagram 5.3.

Diagram 5.4 - Generator Belt Tension Measurement

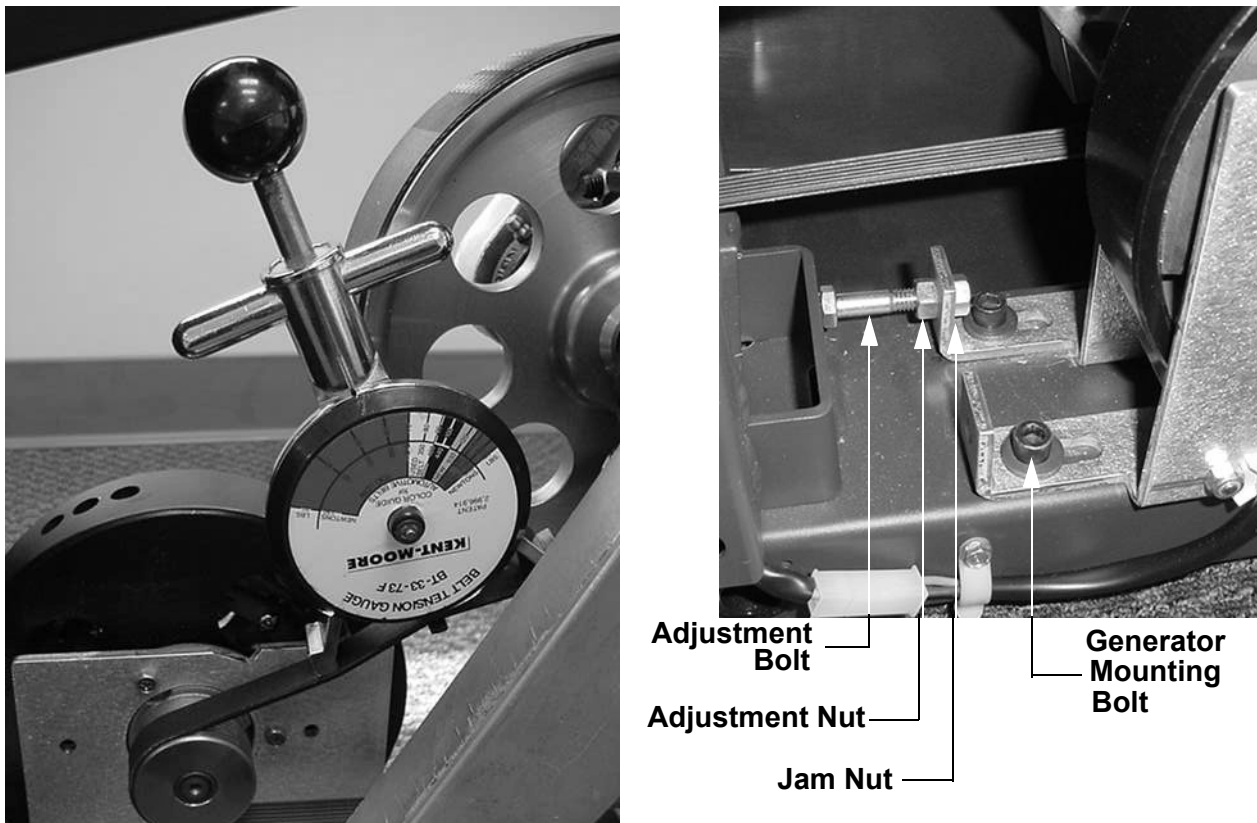

7. The belt gauge should read 60 lbs. If the generator belt tension is significantly high or low, it may be adjusted using the adjustment bolt shown in Diagram 5.3. First loosen, but do not remove the four generator mounting bolts and the jam nut. Hold the adjustment bolt head with one wrench and turn the adjustment nut to change the belt tension. When the tension is correct, tighten the jam nut. Tighten and torque the four generator mounting bolts to 150 inch pounds.
8. If either the input pulley belt or the generator belt is being replaced with a new belt, the belt tension should be set 20 lbs. higher than the previous readings. Therefore a new input pulley belt should be tensioned to 120 lbs. and a new generator belt should be tensioned to 80 lbs. Over time and use the belts will “relax” and the tensions will be as stated in steps 4 and 7.

9. Reconnect the red battery lead to terminal M6 of the lower PCA.

Procedure 5.4 - Calibrating the Lift Motor

1. Remove both front covers.
2. Remove the four screws that fasten the lift motor yoke into the ramp.
3. Carefully, slide the lift motor yoke out of the ramp and lower the ramp until it is resting on the frame.

Diagram 5.5 - Lift Motor Mounting and Calibration

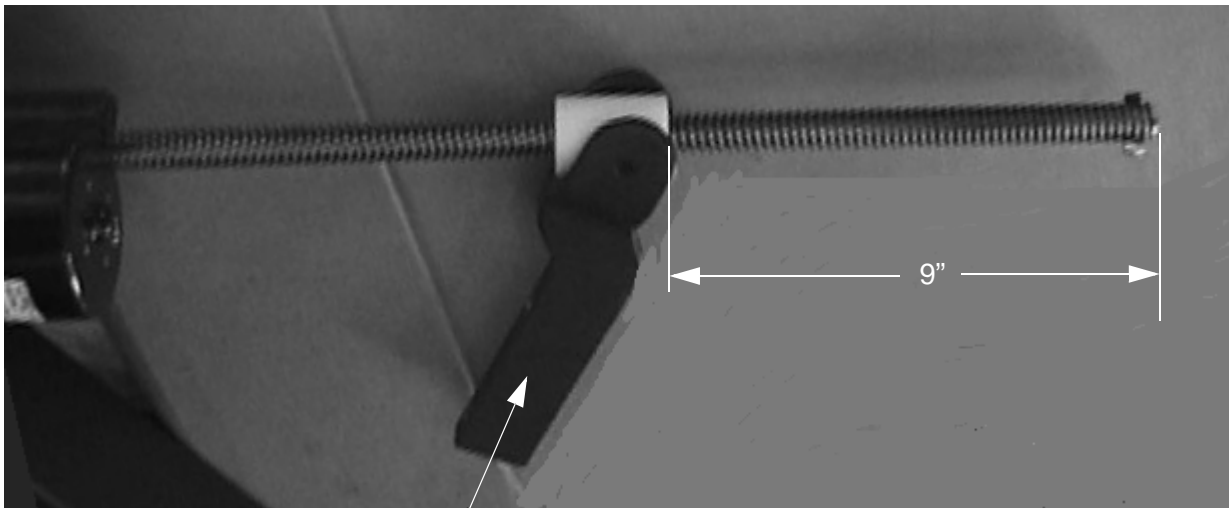

Lift Yoke

4. Access the lift A/D reading via the Lift Test portion of the Diagnostic Program, see Procedure 3.2.
5. With the A/D number displayed set it for a reading of 127 using the **CROSSRAMP ▼** and **CROSSRAMP ▲** keys.
6. Rotate the lift yoke on the lift motor drive screw until the measurement between the top of the lift nut and the end of the lift motor drive screw is 9 inches. See Diagram 5.4. While rotating the lift motor yoke, do not allow the lift motor drive screw to rotate. If the lift motor drive screw rotates, the A/D number will change. The A/D number must be 127 and the physical measurement must be 9 inches for the calibration to be correct.
7. Lift the ramp off of the frame and slide the lift motor yoke into the ramp. Do not rotate the lift any more than is absolutely necessary to align the lift motor yoke with the ramp.
8. Apply a light coating of blue loctite to the four screws removed in step 2. Fasten the lift motor yoke with the loctited screws and torque them to 240 inch pounds.

Procedure 6.1 - Troubleshooting the Lower and Upper Interconnect Cable

Typical symptoms associated with a defective interconnect cable is either an error 30 or no power to the upper PCA. This procedure requires that you have a known good upper interconnect cable, lower interconnect cable and mid-point connector

9. If you are troubleshooting an error 30, 31 or 32 continue with step 3, otherwise see Procedure 6.3 (C524) or Procedure 6.4 (C524i).
10. Pry the end cap out of the front of the frame base tube (See Diagram 6.1).
11. Carefully withdraw both cables and mid-point connector.

Diagram 6.1 - Interconnect Cables and Mid-Point Connector

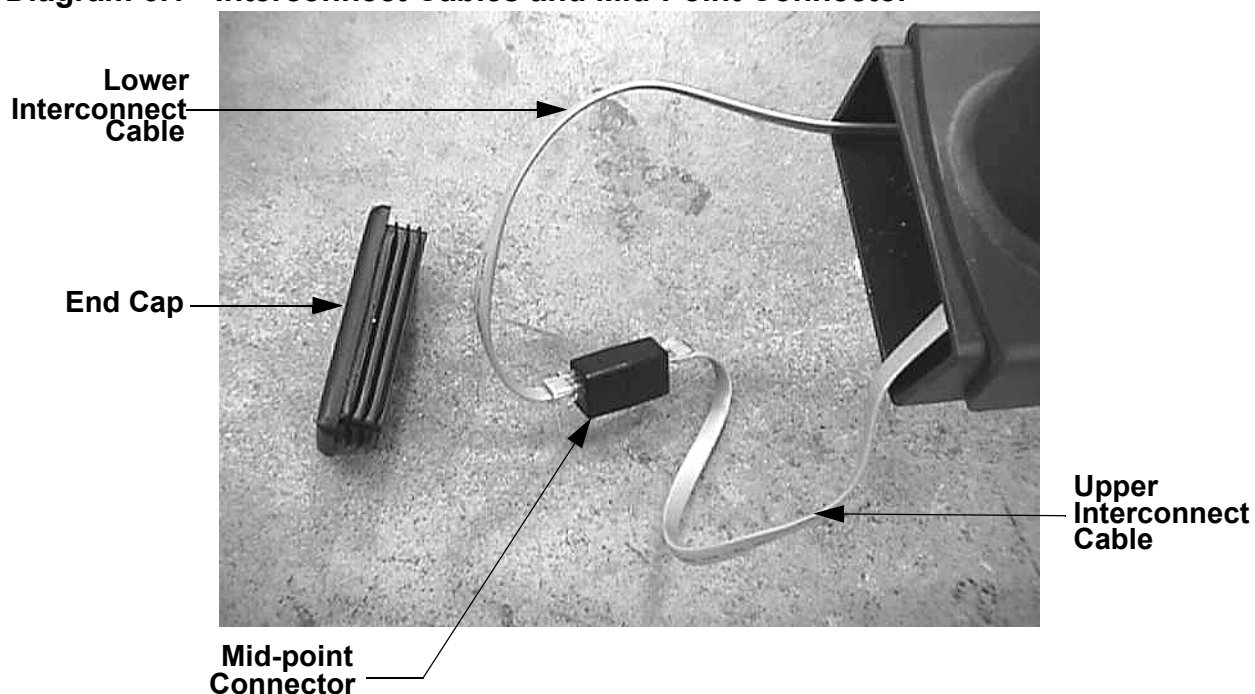

12. Disconnect both cables from the mid-point connector and replace the mid-point connector with a known good mid-point connector. If the mid-point connector does not correct the problem, replace the original mid-point connector and continue with step 5.

13. Remove the rear cover. Disconnect the lower interconnect cable from the lower PCA and the mid-point connector. Substitute a known good interconnect cable from the lower PCA to the mid-point connector. It is not necessary to route the test interconnect cable through the frame tube, for convenience route it externally.
14. If the lower interconnect cable corrects the problem, replace the cable per Procedure 7.4. If the lower interconnect cable does not correct the problem, re-connect the original lower interconnect cable to the lower PCA and mid-point connector and continue with step 7.
15. Remove the upper display housing per Procedure 7.1, steps 1 to 4. Disconnect the upper interconnect cable from the mid-point connector. Substitute a known good interconnect cable from the upper PCA to the mid-point connector. It is not necessary to route the test interconnect cable through the frame tube, for convenience route it externally.
16. If the upper interconnect cable corrects the problem, replace the cable per Procedure 7.4. If the upper interconnect cable does not correct the problem, re-connect the original upper interconnect cable to the mid-point connector and continue with step 9.
17. Replace the upper PCA per Procedure 7.1, steps 9 to 11.
18. If you have performed all of the procedures above and have been unable to correct the problem, call Precor customer service.

Procedure 6.2 - Troubleshooting the Keypad and Upper PCA

If the function keys on the electronic console are unresponsive, the problem may be either the upper PCA or keypad. The keys on this unit are touch sensitive keys. It is necessary to use the keypad diagnostics to troubleshoot the key functions.

WARNING

Before continuing with this procedure, review the Warning and Caution statements listed in Section One.

1. Attach the anti-static wrist strap to your arm, then connect the ground lead of the wrist strap to the units frame.
2. If the EFX powers up and functions normally until a particular key(s) is pressed, skip to step 12.
3. If an Error 5 “key depressed” message is immediately displayed when the EFX is powered up, continue with the next step.
4. This condition may be caused by either the keypad or upper PCA.
5. Remove the five screws that fastens the display housing front panel to the display housing backing plate. These screws are located on the rear of the display housing backing plate.
6. Lift the display housing front panel off of the display housing backing plate. Remove the keypad connector from the upper PCA. See Diagram 6.2.

Diagram 6.2 - Upper PCA & Keypad

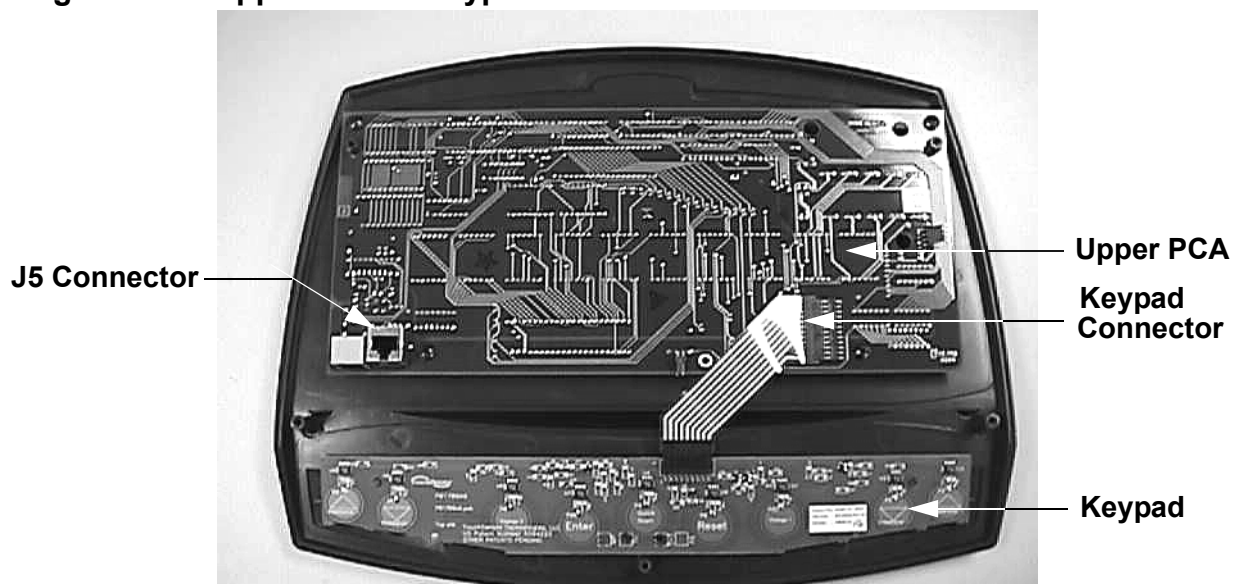

7. Set the on/off switch in the “on” position.
8. If an Error 5 “key depressed” message is immediately displayed when the EFX is powered up, replace the upper PCA.
9. If a “key depressed” message is not displayed when the EFX is powered up, replace the display housing front panel. The display housing front panel is equipped with the keypad.
10. If you have performed all of the procedures above and have been unable to correct the problem, call Precor customer service.
11. Access the diagnostics program per procedure 3.2. If the key(s) necessary to access the diagnostic program is not functioning, skip to step 14.
12. Test the keypad per Procedure 3.2, step 4.
13. If all of the keys test good, the problem may be user error or a key function that is normally disabled during a particular user program.
14. If one or more keys do not function correctly, either the keypad (display housing) or upper PCA could be defective. Replace the display and repeat step 12. If the display housing did not correct the problem, re-install the original display housing and replace the upper PCA.
15. If you have performed all of the procedures above and have been unable to correct the problem, call Precor customer service.

Procedure 6.3 - Upper Display does not illuminate (C524, only)

1. Because this is self powered unit, the display will not illuminate until it is used or the optional external power supply is equipped. If the optional external power supply is equipped, the display should be constantly illuminated. If the optional external power supply is not equipped, the unit must be used at a stride rate of 40 strides per minute or higher for the display to illuminate.
2. If the optional external power supply is not equipped, skip to step 5.
3. Disconnect the optional external power supply from the EFX and measure between the inner and outer sleeves of the power supply's output jack with a DC voltmeter. You should measure approximately 18 VDC.
4. If the voltage measured in step 3 was significantly low, replace the optional external power supply. If the voltage measured in step 3 was 0 Vdc, disconnect external power supply from its AC outlet and measure the voltage at the AC outlet. If the AC outlet voltage is normal replace the optional external power supply. If the AC outlet voltage is significantly low or 0 Vdc, the AC system must be inspected by an electrician.
5. Troubleshoot the generator per Procedure 6.5 (C524) or Procedure 6.6 (C524i).
6. If the generator was found to be good, the problem will be in either the lower PCA, upper PCA or the upper to lower PCA interconnect cables.

Warning

Because this is a self powered unit, it will either be necessary to either equip the unit with the optional external power supply or have an assistant pedal on the unit while voltage measurements are being taken. Because of the danger of working on the unit while it is in motion using the optional external power supply is strongly recommended.

7. Remove the rear cover and disconnect the interconnect cable from the J2 connector of the lower PCA.
8. The following voltage reading must be taken while the unit is in motion. Extreme care must be taken to keep meter leads, hands, etc. clear of all moving parts. Using a DC voltmeter, measure the voltage between pins 1 and 8 of the J2 connector or between TP20 and TP6. See Diagram 6.3. The voltage measured should be approximately 8.5 Vdc. If the voltage is significantly low, replace the lower PCA.
9. Reconnect the interconnect cable to the J2 connector of the lower PCA and repeat the voltage measurement in step 8. The voltage measured should be approximately 8.5 Vdc. If the voltage is significantly low, the problem is in the upper PCA or the upper to lower PCA interconnect cables.

Diagram 6.3 - Partial View of Lower PCA

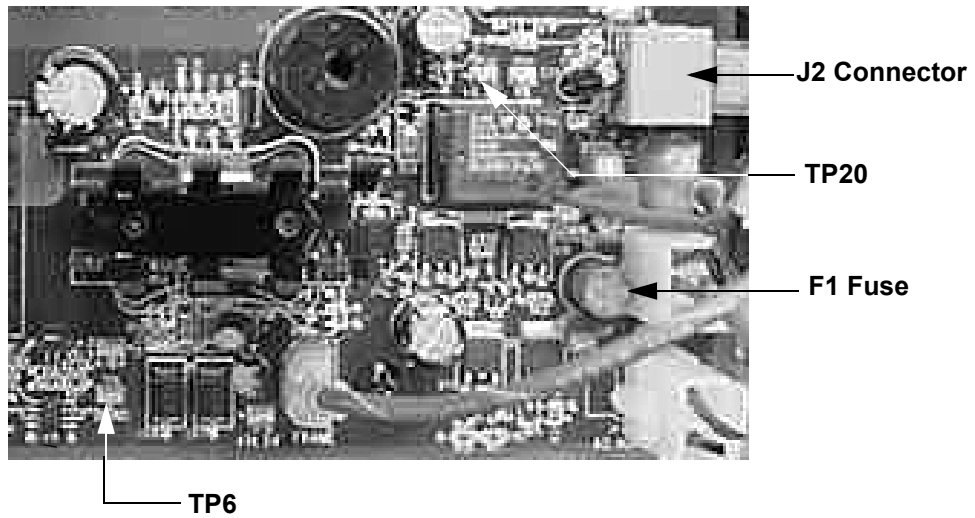

10. Troubleshoot the upper to lower PCA interconnect cables per Procedure 6.1.
11. If the upper to lower interconnect cables are found to be good, replace the upper PCA.
12. If you have performed all of the above tests and are unable to resolve the problem, contact Precor customer support.

Procedure 6.4 - Upper Display does not illuminate (C524i, only)

1. Because this is self powered unit, the display will not illuminate until it is used or the optional external power supply is equipped. If the optional external power supply is equipped, the display should be constantly illuminated. If the optional external power supply is not equipped, the unit must be used at a stride rate of 20 strides per minute or higher for the display to illuminate.
2. If the optional external power supply is not equipped, skip to step 5.
3. Disconnect the optional external power supply from the EFX and measure between the inner and outer sleeves of the power supply's output jack with a DC voltmeter. You should measure approximately 18 VDC.
4. If the voltage measured in step 3 was significantly low, replace the optional external power supply. If the voltage measured in step 3 was 0 Vdc, disconnect external power supply from its AC outlet and measure the voltage at the AC outlet. If the AC outlet voltage is normal replace the optional external power supply. If the AC outlet voltage is significantly low or 0 Vdc, the AC system must be inspected by an electrician.
5. Troubleshoot the generator per Procedure 6.4.
6. If the generator was found to be good, the problem will be in either the lower PCA, upper PCA or the upper to lower PCA interconnect cables.

Warning

Because this is a self powered unit, it will either be necessary to either equip the unit with the optional external power supply or have an assistant pedal on the unit while voltage measurements are being taken. Because of the danger of working on the unit while it is in motion using the optional external power supply is strongly recommended.

7. Remove the rear cover and disconnect the interconnect cable from the J2 connector of the lower PCA.
8. The following voltage reading must be taken while the unit is in motion. Extreme care must be taken to keep meter leads, hands, etc. clear of all moving parts. Using a DC voltmeter, measure the voltage between TP13 (+5D) and TP4 (DGND). Refer to Diagram 6.5. The voltage measured should be approximately 5 Vdc. If the voltage is significantly low, replace the lower PCA. Additionally, the DS1 LED should illuminate.
9. Reconnect the interconnect cable to the J2 connector of the lower PCA and repeat the voltage measurement in step 8. The voltage measured should be approximately 5 Vdc. If the voltage is significantly low, the problem is in the upper PCA or the upper to lower PCA interconnect cables.

Diagram 6.4 - Partial View of Lower PCA



10. Troubleshoot the upper to lower PCA interconnect cables per Procedure 6.1.
11. If the upper to lower interconnect cables are found to be good, replace the upper PCA.
12. If you have performed all of the above tests and are unable to resolve the problem, contact Precor customer support.

Procedure 6.5 - Troubleshooting the Generator (C524, only)

The generator performs three functions in the EFX. First, by controlling the amount of electrical load applied to the generator, the user's pedalling resistance is controlled. Second, the generator is used to charge the EFX's internal battery. Lastly, one of the generator's three phase output windings is monitored to determine when the unit is in use and when it is idle. This system also determines the stride rate by determining the operating speed (output frequency) of the monitored generator winding.

Warning

Because this is a self powered unit, it will either be necessary to either equip the unit with the optional external power supply or have an assistant pedal on the unit while voltage measurements are being taken. Because of the danger of working on the unit while it is in motion using the optional external power supply is strongly recommended.

1. Perform the generator resistance test per Procedure 5.1 (C524) or Procedure 5.2 (C524i). If any of the resistance measurements are significantly high or significantly low, replace the generator.
2. The following voltage reading must be taken while the unit is in motion. Extreme care must be taken to keep meter leads, hands, etc. clear of all moving parts. Using an AC voltmeter, measure the voltage between M3 and M4, M4 and M5, M3 and M5 on the lower PCA. All three AC voltage readings will vary depending on the unit's stride rate at the time the measurement is taken. At a stride rate of 100 strides per minute, all three voltage readings will be approximately 100 VAC.
3. If any of the three readings in step 2 are significantly low, replace the generator.
4. If you have performed all of the above tests and are unable to resolve the problem, contact Precor customer support.

Procedure 6.6 - Troubleshooting the Generator (C524i, only)

The generator performs three functions in the EFX. First, by controlling the amount of electrical load applied to the generator, the user's pedalling resistance is controlled. Second, the generator is used to charge the EFX's internal battery. Lastly, one of the generator's six phase output windings is monitored to determine when the unit is in use and when it is idle. This system also determines the stride rate by determining the operating speed (output frequency) of the monitored generator winding.

Warning

Because this is a self powered unit, it will either be necessary to either equip the unit with the optional external power supply or have an assistant pedal on the unit while voltage measurements are being taken. Because of the danger of working on the unit while it is in motion using the optional external power supply is strongly recommended.

1. Perform the generator resistance test per Procedure 5.3. If any of the resistance measurements are significantly high or significantly low, replace the generator.
2. The following voltage reading must be taken while the unit is in motion. Extreme care must be taken to keep meter leads, hands, etc. clear of all moving parts. Using an AC voltmeter, measure the voltage between 1 & 3, 2 & 3, 5 & 7 and 6 & 7 on J1 of the lower PCA. All AC voltage readings will vary depending on the unit's stride rate at the time the measurement is taken. At a stride rate of 100 strides per minute, all three voltage readings will be approximately 100 VAC -110 VAC.
3. If any of the six readings in step 2 are significantly low, replace the generator.
4. If you have performed all of the above tests and are unable to resolve the problem, contact Precor customer support.

Procedure 6.7 - Troubleshooting the Lift Motor

The lift motor is a 12 Vdc motor with an internally driven 1 K Ω potentiometer used to track ramp position. Because the lift motor is a DC motor, lift motor direction is controlled by the polarity of the DC voltage applied to the lift motor. When a positive voltage is applied to the lift motor, the lift motor will move upward. When a negative voltage is applied to the lift motor, the lift motor will move downward. As the lift motor moves the 1 K Ω potentiometer is rotated via an internal gear drive system. The potentiometer's changing resistance is fed to the lift control system and converted to an A/D (analog to digital) reading that is used in the diagnostics system to indicate ramp position.

The ramp operating system has a battery monitoring system. If the battery voltage falls below 11 Vdc when ramp movement is initiated or the battery voltage falls below 10 Vdc after ramp movement has been initiated, ramp movement will be stopped and the message "**NO RAMP LOW VOLTAGE**" will be displayed. Ramp motion will not be enabled until such time as the battery voltage exceeds the above limits. The battery voltage must be raised to correct this condition either by battery charging or battery replacement. This is strictly a battery problem and not a lift system or lift motor problem.

1. If an Error 40 (no lift movement) is being displayed continue with step 2. If an Error 42 is being displayed (lift out of range) skip to step 12.
2. If the lift moves briefly and then displays an Error 40, skip to step 12. If the lift does not move prior to displaying the Error 40 continue with step 3.
3. Remove the rear cover. Remove the F1 fuse (6.3 amps) from the lower PCA. See Diagram 6.4. Check the fuse resistance using an ohmmeter. The fuse should read 1 Ω or less. If the reading is significantly high, replace the fuse. If the fuse is good or replacing the fuse does not correct the problem, continue with step 4.
4. Enter the diagnostic program per Procedure 3.2. Using the diagnostic program allows you to test the lift system without continuously pedalling the unit. Connect a DC volt meter to the J3 connector on the lower PCA as follows: voltmeter common lead to terminal 3 (black wire) and voltmeter "hot" lead to terminal 2 (red wire). Using the **CROSSRAMP** \blacktriangledown , \blacktriangle keys operate the lift. The voltmeter should read +12 Vdc when the lift is instructed to move upward and -12 Vdc when the lift is instructed to move downward.
5. If when the **CROSSRAMP** keys are pressed, the display does not indicate that the lift should be moving, troubleshoot the upper PCA and keypad per Procedure 6.2.
6. If the voltage measurements in step 4 are correct continue with step 7. If either voltage measurement in step 4 is significantly low, replace the lower PCA.
7. Verify that all of the wires in the intermediate lift cable (the cable inserted in to J3 of the lower PCA) are securely inserted into the connector housing and providing a good electrical connection.

8. Remove both front covers. Enter the diagnostic program, if necessary, per Procedure 3.2. Using the diagnostic program allows to test the lift system without continuously pedalling the unit. Connect a DC volt meter to the lift motor cable as follows: voltmeter common lead to terminal 2 (brown wire) and voltmeter “hot” lead to terminal 3 (red wire). Using the **CROSSRAMP ▼,▲** keys operate the lift. The voltmeter should read +12 Vdc when the lift is instructed to move upward and -12 Vdc when the lift is instructed to move downward.
9. If the voltage measurements in step 8 are correct replace the lift motor. If either voltage measurement in step 4 is significantly low, continue with step 10.
10. Verify that all of the wires in the intermediate lift cable (the cable inserted in to J3 of the lower PCA) are securely inserted into the connector housing and providing a good electrical connection.
11. If you have performed all of the above tests and are unable to resolve the problem, contact Precor customer support
12. Enter the diagnostic program per Procedure 3.2 and advance to the **Lift Test**. If the A/D reading is either 0 or 255, skip to step 15.
13. Using the **CROSSRAMP ▼,▲** keys operate the lift. If the A/D reading tracks the lift movement smoothly without skips, calibrate the lift motor per Procedure 5.4 and re-test lift functions in a normal operating mode.
14. If the A/D reading was erratic and did not smoothly follow lift motion, visually check the connections between the lift intermediate cable and the J3 connector on the lower PCA and between the lift intermediate cable lift motor cable.
15. Exit the diagnostics program, and leave the unit idle long enough for it to “shut off”. Disconnect the red battery lead from terminal M6 of the lower PCA. Remove the lift intermediate cable from the J3 connector of the lower PCA. Using an ohmmeter, test between terminal 4 (green wire) and terminal 6 (brown wire) of the lift intermediate cable. The ohmmeter should read approximately 1000Ω.
16. Test between terminal 4 (green wire) and terminal 5 (black wire) of the lift intermediate cable and between terminal 5 (black wire) and terminal 6 (brown wire) of the lift intermediate cable. These two readings should total approximately 1000Ω.
17. If the readings in steps 15 and 16 are correct, skip to step 19. If either reading is significantly high or low, continue with step 18.
18. Disconnect the lift intermediate cable from the lift motor cable. Using an ohmmeter read each of the six wires in the lift intermediate cable from end to end. Each of the wires in the lift intermediate cable should read less than 1Ω. If any of the readings are significantly high, replace the lift intermediate cable. If all of the readings are correct, continue with step 19.
19. Replace the lift motor. Calibrate the lift motor per Procedure 5.4.

Procedure 7.1 - Replacing the Display Enclosure or Upper PCA

Anti-static kits (part number 20024-101) can be ordered from Precor.

The keyboard is part of the display housing front panel. If the keyboard is not functioning properly, replace the display housing front panel.

Removing the Display Housing Front Panel

1. Remove the rear cover and disconnect the red battery lead from terminal M6 of the lower PCA.

WARNING

Before continuing with this procedure, review the Warning and Caution statements listed in Section One, Things You Should Know.

2. Attach the anti-static wrist strap to your arm, then connect the ground lead of the wrist strap to the units frame.
3. Remove the four screws that secure the display housing front panel to the display backing plate.
4. Attach the wrist strap to your arm, then connect the ground lead of the wrist strap to the EFX frame.
5. Disconnect the upper interconnect cable from the upper PCA (connector J5).

Removing and Replacing the Upper PCA

6. Carefully disconnect the keyboard cable from the upper PCA (connector J2).
7. Remove the four screws that secure the upper PCA to the display housing front panel.

Note:

Package the upper PCA in an anti-static bag and document the problem as described in Procedure 3.6, Documenting Software Problems.

Diagram 7.1 - Display Housing Front Panel, Rear View

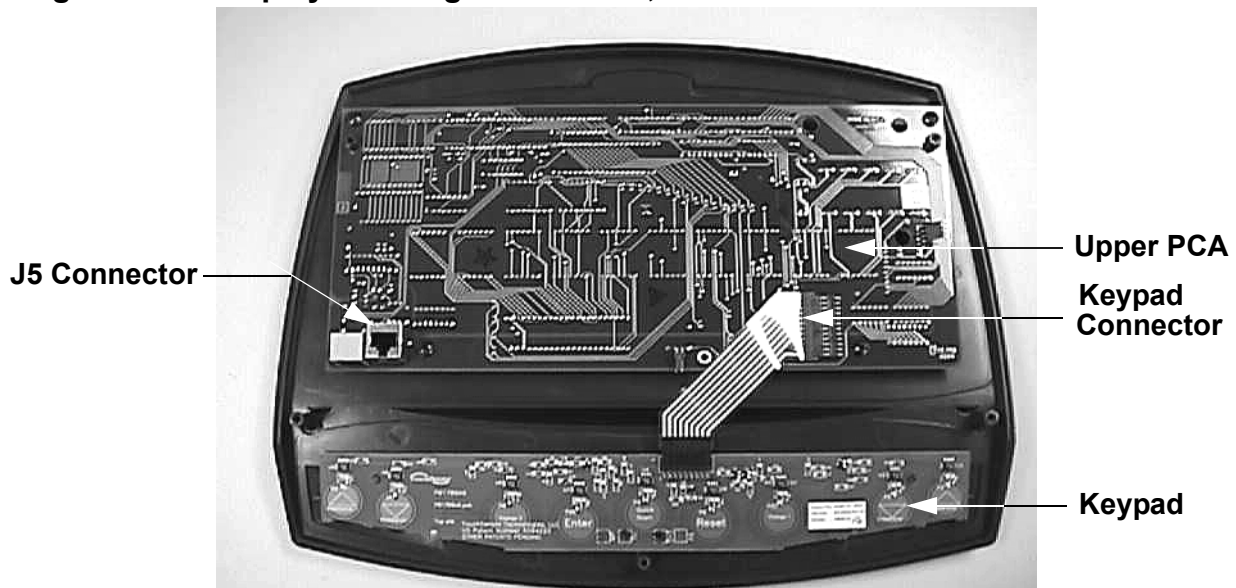

8. Position the upper PCA at its mounting location on the display housing front panel (refer to Diagram 7.1). Replace and tighten the upper PCA mounting screws.
9. Reconnect the keyboard cable to the upper PCA.
10. Reconnect the upper interconnect cable to the upper PCA.
11. Remove the ground lead of the wrist strap from the EFX frame, then remove the wrist strap from your arm.
12. Position the display enclosure on the display plate. Replace and tighten the display mounting screws.
13. Replace the red battery lead removed in step 1 and check unit operation as described in Section Four.

Procedure 7.2 - Replacing the Lower PCA (C524, only)

Removing the Lower PCA

1. Remove the rear cover and disconnect the red battery lead from terminal M6 of the lower PCA.

WARNING

Before continuing with this procedure, review the Warning and Caution statements listed in Section One, Things You Should Know.

2. Remove the rear cover per Procedure 7.15.
3. Attach the wrist strap to your arm, then connect the ground lead of the wrist strap to the EFX frame.
4. Disconnect all of the cables and wiring from the lower PCA.
5. Remove the four screws that secure the lower PCA to the drive unit upright, see Diagram 7.2.

Diagram 7.2 - Lower PCA

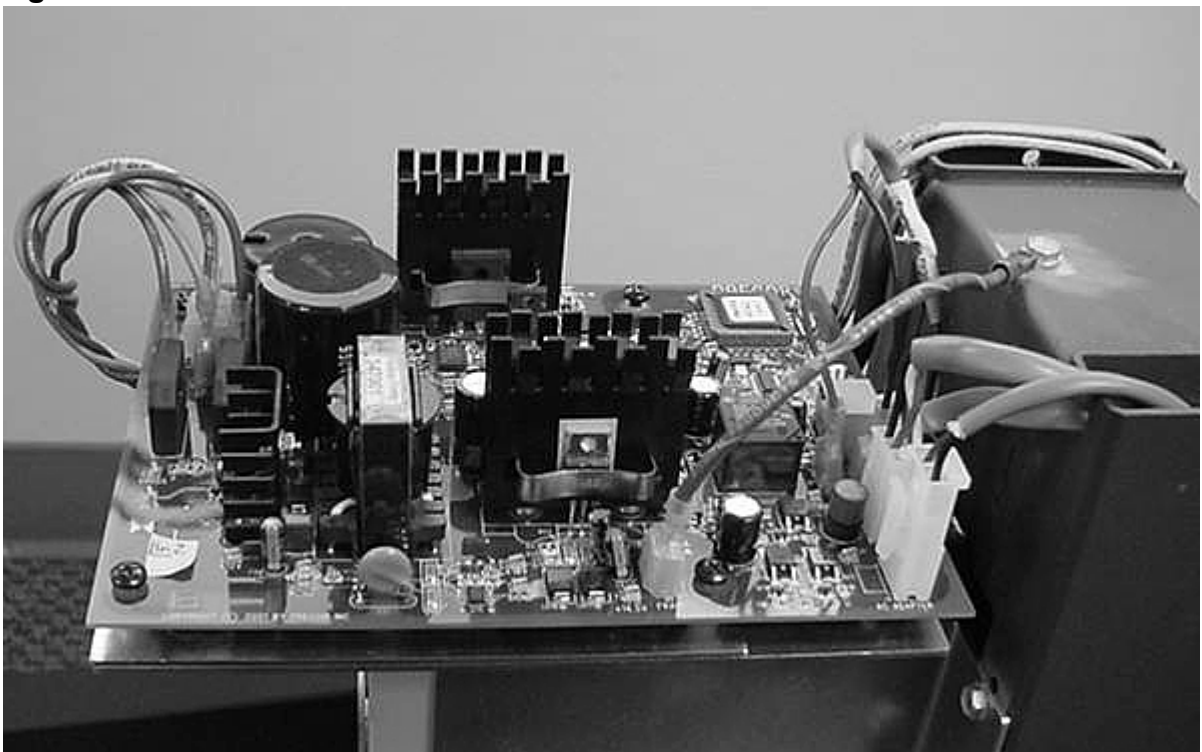

Replacing the Lower PCA

6. Position the replacement lower PCA at its mounting position and fasten the lower PCA with the four screws removed in step 5.
7. Reconnect the lower PCA cables and wiring as follows. Connect the interconnect cable to connector J2. The 2 conductor cable (red and black wires) from the input power jack to the J4 connector. The 3 conductor cable from the generator as follows: brown to AC1, blue to AC2 and violet to AC3. Connect the green/yellow frame ground wire to M8. From the battery, connect the red wire to M6 and the black wire to M7 of the lower PCA. Connect the two leads from the load resistors to M1 and M2, the polarity of the load leads is not critical, either lead may be connected to either the M1 or M2 terminal.
8. Remove the ground lead of the wrist strap from the EFX frame, then remove the wrist strap from your arm.
9. Re-install the rear cover, then check the operation of the EFX as described in Section Four.

Procedure 7.3 - Replacing the Lower PCA (C524i, only)

Removing the Lower PCA

1. Remove the rear cover and disconnect the red battery lead from terminal M6 of the lower PCA.

WARNING

Before continuing with this procedure, review the Warning and Caution statements listed in Section One, Things You Should Know.

2. Remove the rear cover per Procedure 7.19.
3. Attach the wrist strap to your arm, then connect the ground lead of the wrist strap to the EFX frame.
4. Disconnect the all of cables and wiring from the lower PCA.
5. Remove the four screws that secure the lower PCA to the drive unit upright, refer to Diagram 7.3.

Diagram 7.3 - Lower PCA

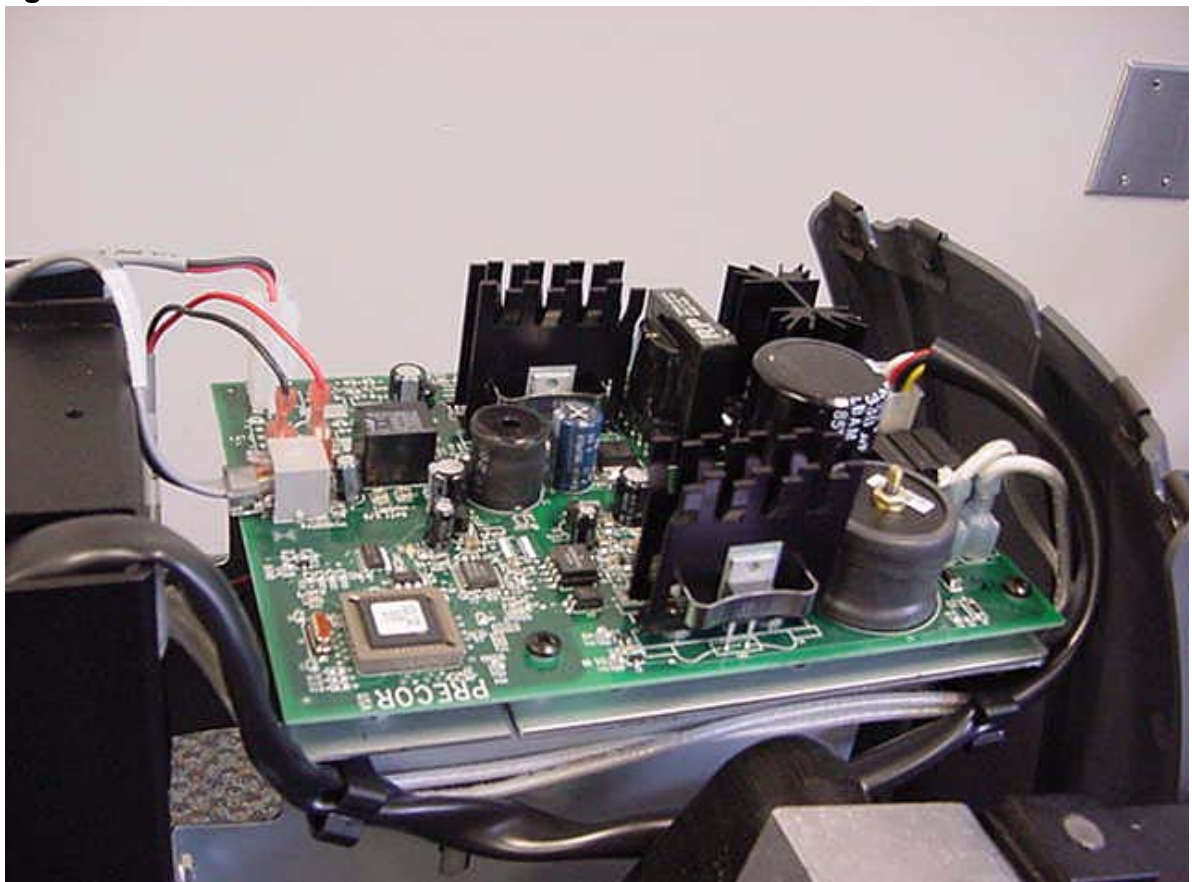

Replacing the Lower PCA

6. Position the replacement lower PCA at its mounting position and fasten the lower PCA with the four screws removed in step 5.
7. Reconnect the lower PCA cables and wiring as follows. Connect the interconnect cable to connector J2. The 2 conductor cable (red and black wires) from the input power jack to the J4 connector. The 6 conductor cable from the generator as to connector J1. From the battery, connect the red wire to M6 and the black wire to M7 of the lower PCA. Connect the two leads from the load resistors to M1 and M2, the polarity of the load leads is not critical, either lead may be connected to either the M1 or M2 terminal.
8. Remove the ground lead of the wrist strap from the EFX frame, then remove the wrist strap from your arm.
9. Re-install the rear cover, then check the operation of the EFX as described in Section Four.

Procedure 7.4 - Replacing the Upper and/or Lower Interconnect Cables

Procedure

Note: Before you install a new interconnect cable, ensure that the interconnect cable is defective. Refer to Procedure 6.1.

1. Remove the rear cover and disconnect the red battery lead from terminal M6 of the lower PCA.
2. Pry the end cap out the front of the frame base tube with a thin bladed screwdriver (See Diagram 7.5).
3. Carefully withdraw both cables and mid-point connector.

Diagram 7.4 - Interconnect Cables and Mid-Point Connector

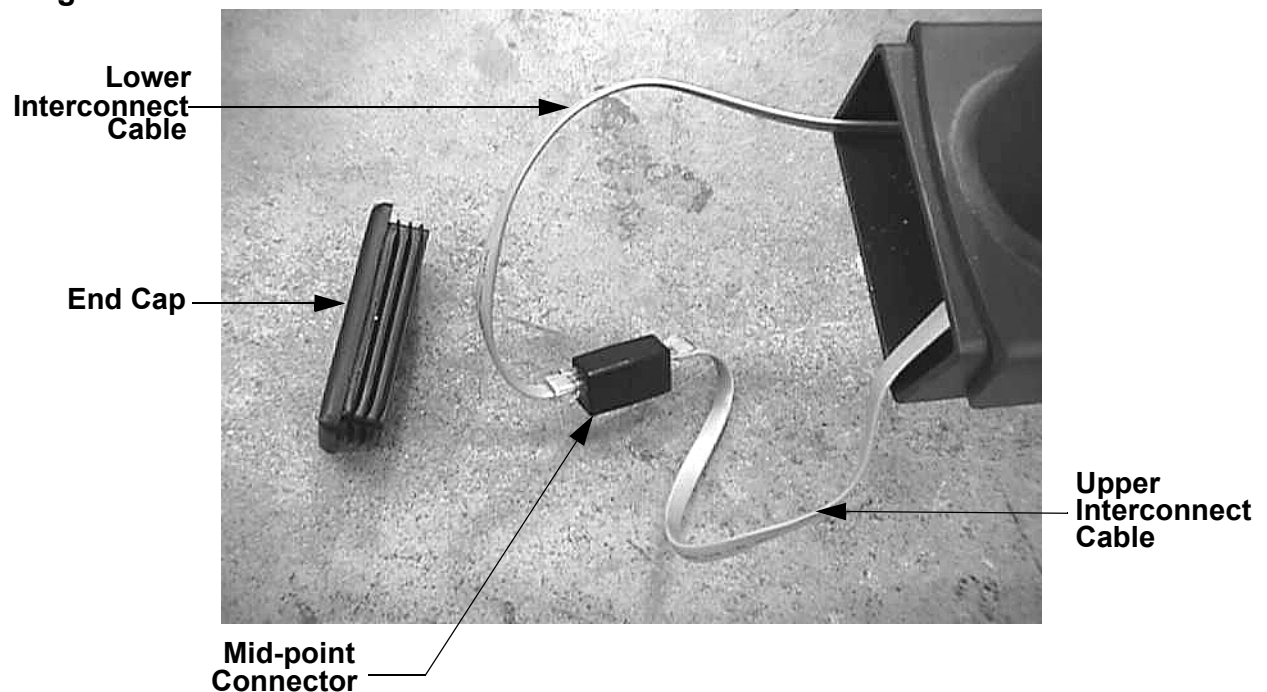

4. If you are replacing the upper interconnect cable skip to step 9. If you are replacing the lower interconnect cable continue with step 5.
5. Remove the left and right rear cover sections. Disconnect the interconnect cable from the lower PCA.

6. Securely tape one end of the replacement lower interconnect cable to the lower PCA end of the existing lower interconnect cable. Carefully draw the existing lower interconnect cable out of the front of the frame as you carefully feed the replacement cable into the access hole near the lower PCA.
7. When the replacement interconnect cable emerges from the front of the frame, separate the interconnect cables and discard the defective interconnect cable. Connect the replacement interconnect cable to the lower PCA and mid-point connector. Rotate the lower PCA bracket into it's mounting position and fasten it with the screws removed in step 5.
8. Replace the right and left rear cover sections and front frame end cap. Thoroughly, test the unit per Section 4.
9. Remove the display housing per Procedure 7.2, steps 2 to 4. Set the display housing aside. Disconnect the interconnect cable from the upper PCA. Remove the four screws that fasten the display housing backplate to the main column. Remove the display housing backplate.
10. Securely tape one end of the replacement lower interconnect cable to the upper PCA end of the existing upper interconnect cable. Carefully draw the existing upper interconnect cable out of the front of the frame as you carefully feed the replacement cable into the main column.
11. When the replacement interconnect cable emerges from the front of the frame, separate the interconnect cables and discard the defective interconnect cable. Connect the replacement interconnect cable to the mid-point connector.
12. Feed the interconnect cable through the access hole in the display housing backplate and fasten the display housing backplate to the main column with the screws removed in step 9.
13. Connect the upper interconnect cable to the upper PCA and fasten the display housing to the display housing backplate.
14. Replace the red battery lead removed in step 1 and check unit operation as described in Section Four.

Procedure 7.5 - Replacing a Crankarm Assembly

Removing a Crankarm Assembly

WARNING

Before continuing with this procedure, review the Warning and Caution statements listed in Section One, Things You Should Know.

1. It is only necessary to remove the right or left side of the rear cover to access the crankarm being replaced. Remove the necessary side(s) of the rear cover. Disconnect the red battery lead from terminal M6 of the lower PCA.
2. Remove the stairarm assembly as described in Procedure 7.12, steps 2 to 4.

Note:

Notice the position of the two crank arms. When the crankarms are replaced, they must be positioned so that they are 180 degrees opposing.

3. Remove the 14 mm. bolt that secures the crankarm to the input pulley shaft. It will be necessary, use a Pitman arm puller or 4" to 6 "gear puller to remove the crankarm. Do not use a hammer or mallet to remove the crankarm.
4. If you are removing both crank arm assemblies, repeat Steps 3 and 4 for the second crankarm assembly.

Diagram 7.5 - Crankarm

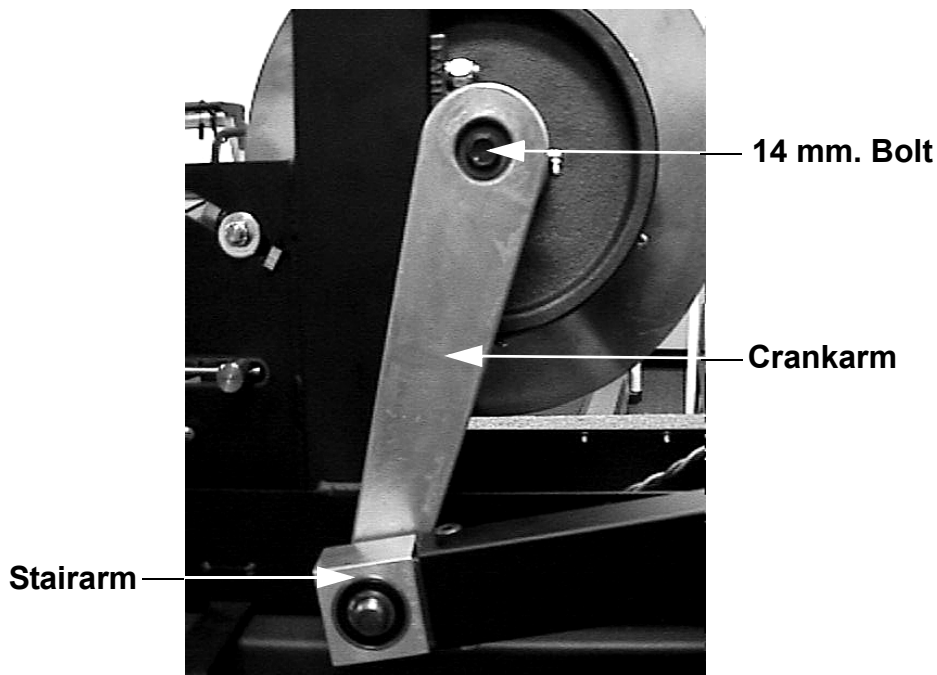

Replacing a Crank Arm Assembly

5. Clean the crankarm mounting bolt threads and the input pulley shaft threads with an alcohol swab. Allow them to dry and apply blue loctite to the crankarm mounting bolt threads.
6. Position the crankarm on the input pulley shaft. Thread and hand tighten the 14 mm. bolt into the input pulley shaft. Torque the nut to 300 in/lbs.
7. Replace the stairarm assembly as described in Procedure 7.11, steps 11 to 12.
8. If you are replacing both crankarm assemblies, repeat steps 6 and 7 for the second crankarm assembly.
9. Set the unit at it's highest resistance setting and use the EFX for a minimum of 3 minutes. Stride in a forward direction for half of the time and in a backward direction for half of the time. Set the on/off switch in the "off" position and re-torque both of the 14 mm. crankarm mounting bolts to 300in/lbs.
10. Replace the red battery lead removed in step 1 and check unit operation as described in Section Four.
11. Replace the rear cover.

Procedure 7.6 - Replacing the Input Pulley Belt

WARNING

Before continuing with this procedure, review the Warning and Caution statements listed in Section One, Things You Should Know.

1. Remove the rear cover and disconnect the red battery lead from terminal M6 of the lower PCA.
2. Remove the stairarm assemblies as described in Procedure 7.11, steps 2 to 4.
3. Remove the crankarm assemblies as described in Procedure 7.5, steps 2 to 5.
4. Remove the input pulley assembly per Procedure 7.8 steps 4 to 7.
5. Remove the left and right tension bolts, locking tabs and brackets from the step up pulley assembly. Remove the generator belt from the generator's pulley.
6. Slide the step up pulley assembly with both the generator and input pulley belts out of the drive unit.
7. Remove the input pulley belt. Set the replacement input pulley belt in its mounting position on the step up pulley assembly.
8. Set the step up pulley assembly with the generator and input belt at its mounting position in the drive unit. Replace the tensioning bolts, locking tabs and brackets removed in step 6. Thread, but do not tighten, the left and right tension bolts into the step up pulley shaft.
9. Place the other end of the generator belt on the generator's pulley.
10. Place the other end of the input pulley belt on the input pulley assembly and mount the input assembly per Procedure 7.8, steps 8 to 12.
11. Replace the crankarm assemblies per Procedure 7.5, steps 6 to 10.
12. Replace the stairarm assemblies per Procedure 7.11, steps, 11 to 12.
13. Tension both belts per Procedure 5.3. Note the differences between tensioning a new belt and an existing (used) belt.
14. Replace the red battery lead removed in step 1 and check unit operation as described in Section Four.

Procedure 7.7 - Replacing the Generator Pulley Belt

WARNING

Before continuing with this procedure, review the Warning and Caution statements listed in Section One, Things You Should Know.

1. Remove the rear cover and disconnect the red battery lead from terminal M6 of the lower PCA.
2. Remove the stairarm assemblies as described in Procedure 7.12, steps 2 to 4.
3. Remove the crankarm assemblies as described in Procedure 7.5, steps 2 to 5.
4. Remove the input pulley assembly per Procedure 7.8, steps 4 to 7.
5. Remove the left and right tension bolts, locking tabs and brackets from the step up pulley assembly.
6. Remove the three generator mounting screws shown in Diagram 7.16.
7. Remove the two bearing clamp screws shown in Diagram 7.17. Remove the bearing clamp.
8. Lift the generator and remove its drive belt.
9. Slide the step up pulley assembly with both the generator and input belts out of the drive unit.
10. Remove and discard the generator belt. Set the replacement generator belt in its mounting position on the step up pulley assembly.
11. Set the step up pulley assembly with the generator and input belt at its mounting position in the drive unit. Replace the tensioning bolts, locking tabs and brackets removed in step 6. Thread, but do not tighten, the left and right tension bolts into the step up pulley shaft.
12. Lift the generator and place the drive belt around the generator's pulley.
13. Replace and tighten the three generator mounting screws removed in step 6. Set the bearing clamp in its mounting position, replace and tighten the two bearing clamp mounting screws removed in step 7.
14. Mount the input assembly per Procedure 7.8, steps 8 to 12.
15. Replace the crankarm assemblies per Procedure 7.5, steps 6 to 10.
16. Replace the stairarm assemblies per Procedure 7.12, steps, 11 to 12.

17. Tension both belts per Procedure 5.3. Note the differences between tensioning a new belt and a existing (used) belt.
18. Replace the red battery lead removed in step 1 and check unit operation as described in Section Four.

Procedure 7.8 - Replacing the Input Pulley Assembly

WARNING

Before continuing with this procedure, review the Warning and Caution statements listed in Section One, Things You Should Know.

1. Remove the rear cover and disconnect the red battery lead from terminal M6 of the lower PCA.
2. Remove the stairarm assemblies as described in Procedure 7.11, steps 2 to 4.
3. Remove the crankarm assemblies as described in Procedure 7.5, steps 2 to 5.
4. Remove the input pulley assembly mounting nuts (2 per pillow block bearing).
5. Remove tension from the input pulley belt as described in step 6:
6. Straighten the locking tabs and turn the left and right tension bolts counterclockwise until tension is removed from the both belts. (See Diagram 5.2)

Diagram 7.6 - Input Pulley Assembly

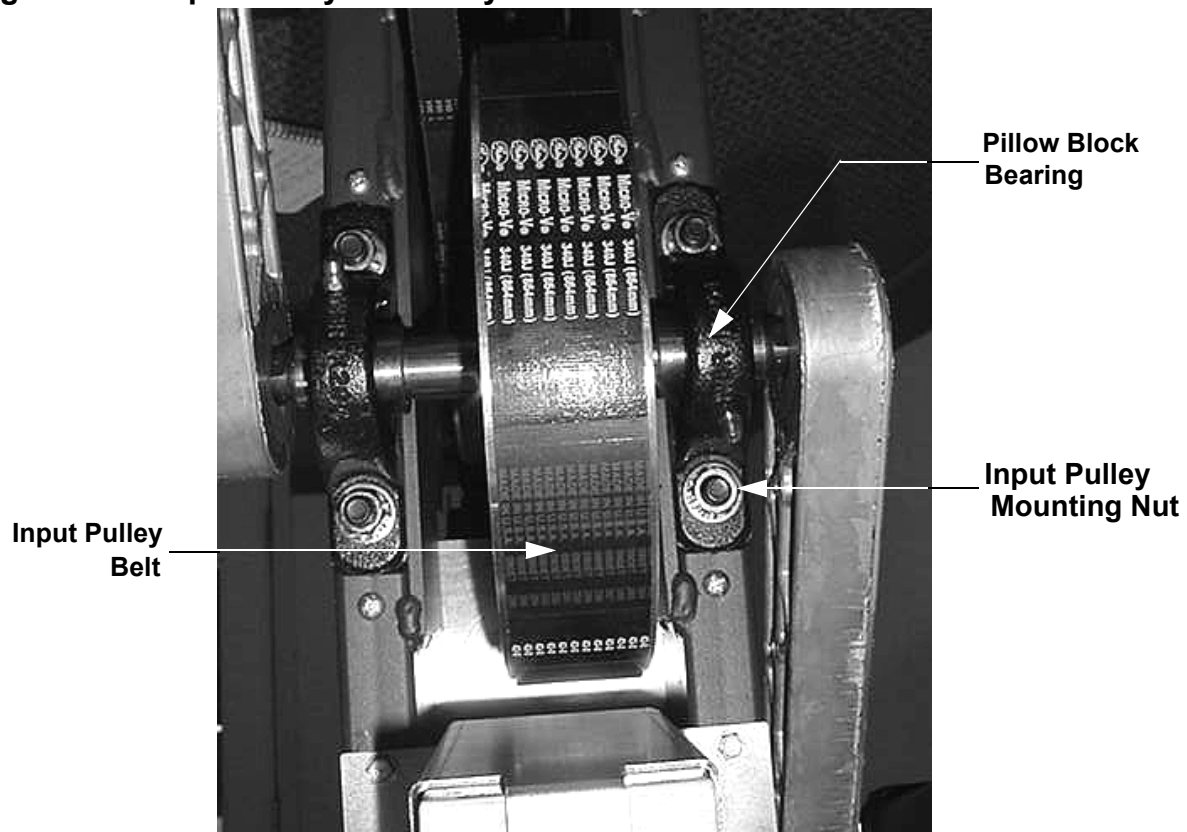

7. Remove the input pulley assembly. Slide input pulley belt off of the input pulley assembly.
8. Hold the replacement input pulley assembly at its mounting position and slide the input belt over and past the pillow block bearing and onto the input pulley assembly.
9. Replace the bolts in one of the pillow block bearings and torque both nuts to 500 inch pounds. Using a mallet or dead blow hammer, tap the other pillow block bearing until the edge of the pillow block bearing is parallel with the edge of the frame upright. Replace the nuts in the other pillow block bearing and torque to 500 in pounds.
10. Replace the crankarms per Procedure 7.5, steps 6 to 10. The crankarms must be parallel to the frame uprights. See Diagram 7.5. If necessary loosen the four drive unit mounting bolts, align the drive unit and torque the drive unit mounting bolts to 500 inch pounds.
11. Tension both belts per Procedure 5.3. Note the differences between tensioning a new belt and a existing (used) belt.
12. Replace the red battery lead removed in step 1 and check unit operation as described in Section Four.
13. Replace the rear cover.

Procedure 7.9- Replacing the Step-Up Pulley Assembly

WARNING

Before continuing with this procedure, review the Warning and Caution statements listed in Section One, Things You Should Know.

1. Remove the rear cover and disconnect the red battery lead from terminal M6 of the lower PCA.
2. Remove the stairarm assemblies as described in Procedure 7.11, steps 2 to 4.
3. Remove the crankarm assemblies as described in Procedure 7.5, steps 2 to 5.
4. Remove tension from the input pulley and generator belts as described below:
 - a. Straighten the locking tabs and turn the left and right tension bolts counterclockwise until tension is removed from both belts. (See Diagram 5.2)
 - b. Remove both tension bolts and slide the input belt off of the step up pulley assembly.
5. Place the input belt and step up belt in place on the replacement step up pulley. Set other end of the generator belt on the generator pulley.
6. Replace the tension bolts and associated hardware removed in step 5b.
7. Tension both belts per Procedure 5.3. Note the differences between tensioning a new belt and a existing (used) belt.
8. Replace the crankarms per Procedure 7.5, steps 6 to 10.
9. Replace the red battery lead removed in step 1 and check unit operation as described in Section Four.
10. Replace the rear cover.

Procedure 7.10 - Replacing a Wheel Assembly

Warning: Care must be taken when work is being performed in the area of the stairarms. Pinch points exist between the stairarm and ramp and between the stairarm and crankarm, when the rear covers are removed.

Procedure

WARNING

Before continuing with this procedure, review the Warning and Caution statements listed in Section One, Things You Should Know.

1. Remove the screws from the wheel axle. If when removing the second wheel axle screw, the axle rotates and the screw does not unthread, insert a 5/32" allen wrench into the end of the axle from which the screw has been removed. The allen wrench will hold the axle while you remove the remaining screw. Remove the wheel assembly from the stairarm.

Diagram 7.7- Wheel Assembly

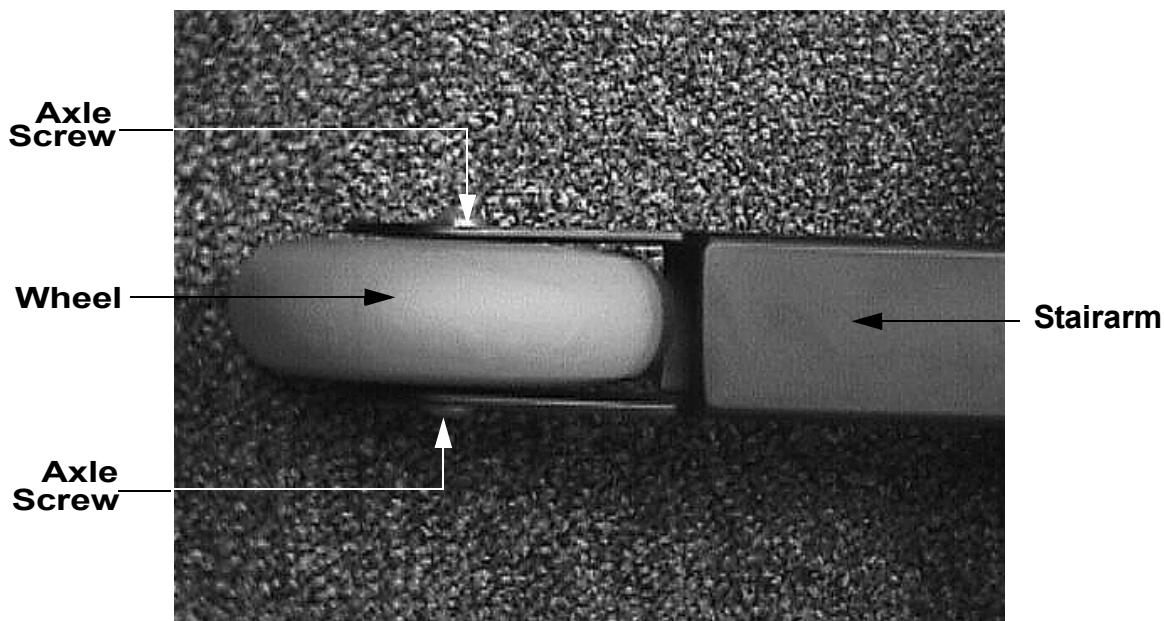

2. Set the replacement wheel in the stairarm and insert and hand tighten the wheel axle screws. Torque the wheel axle screws to 80 in/lbs.
3. **Note:** The wheel axle screws are equipped with a "loctite patch". If the wheel axle screws have been inserted and removed more than two times, red loctite should be used on the wheel axle screws when they are re-installed.
4. Thoroughly test the operation of the wheel assemblies

Procedure 7.11 - Replacing a Stairarm Pedal

1. Loosen and remove the two bolts that fasten the stairarm pedal onto the stairarm.
2. Remove the stairarm pedal from the stairarm.
3. Set the replacement stairarm pedal at it's mounting position on the stairarm.
4. Install and hand tighten the stairarm pedal mounting hardware removed in step 2. Torque the stairarm pedal mounting bolts to 60 in/lbs.

Procedure 7.12 - Replacing a Stairarm

Warning: Care must be taken when work is being performed in the area of the stairarms. Pinch points exist between the stairarm and ramp and between the stairarm and crankarm, when the rear covers are removed.

Procedure

1. Remove the rear cover per Procedure 7.1.
2. Remove the retaining clip that fastens the stairarm pivot block to the crankarm. Slide the stairarm off of the crankarm.
3. Loosen and remove the two bolts that fasten the stairarm pedal onto the stairarm.
4. Remove the stairarm pedal from the stairarm.
5. Set the stairarm pedal at it's mounting position on the replacement stairarm.
6. Install and hand tighten the stairarm pedal mounting hardware removed in step 3. Torque the stairarm pedal mounting bolts to 60 in/lbs.
7. Remove the four screws that fasten the wheel/cover assembly to the stairarm. Remove the wheel/cover assembly from the stairarm.
8. Install the wheel/cover assembly on the replacement stairarm. Install and hand tighten the four wheel/cover assembly screws. Torque the wheel/cover assembly mounting screws to 70 in/lbs.
9. Slide the replace stairarm onto the crankarm. Replace the retaining clip removed in step 2.

Replace the rear cover per Procedure 7.1.

Procedure 7.13 - Replacing a Ramp Assembly

Warning: Care must be taken when work is being performed in the area of the stairarms. Pinch points exist between the stairarm and ramp and between the stairarm and crankarm, when the rear covers are removed.

1. Press the **QUICK START** key, while striding on the unit raise the incline to level 17.
2. Remove the right and left rear covers per Procedure 7.15 and pivot both stairarms to the rear of the unit.
3. Remove the two bolts that fasten the lower rear portion of the ramp to the frame. See Diagram 7.8.

Diagram 7.8 - Lower Ramp Mounting



4. Remove the four bolts (two on top and two on the bottom) that fasten the upper end of the ramp to the lift motor yoke. See Diagram 7.9.
5. Carefully lift the ramp and slide it off of the lift motor yoke.
6. Slide the replacement ramp onto the lift motor yoke and hand start the four upper lift motor bolts removed in step 4. Apply blue loctite to the threads of the lower ramp bolts removed in step 3. Hand start the two lower ramp mounting bolts and then torque them to 35 foot pounds. Torque the four upper ramp mounting bolts to 240 inch pounds.

Diagram 7.9 - Upper Ramp Mounting

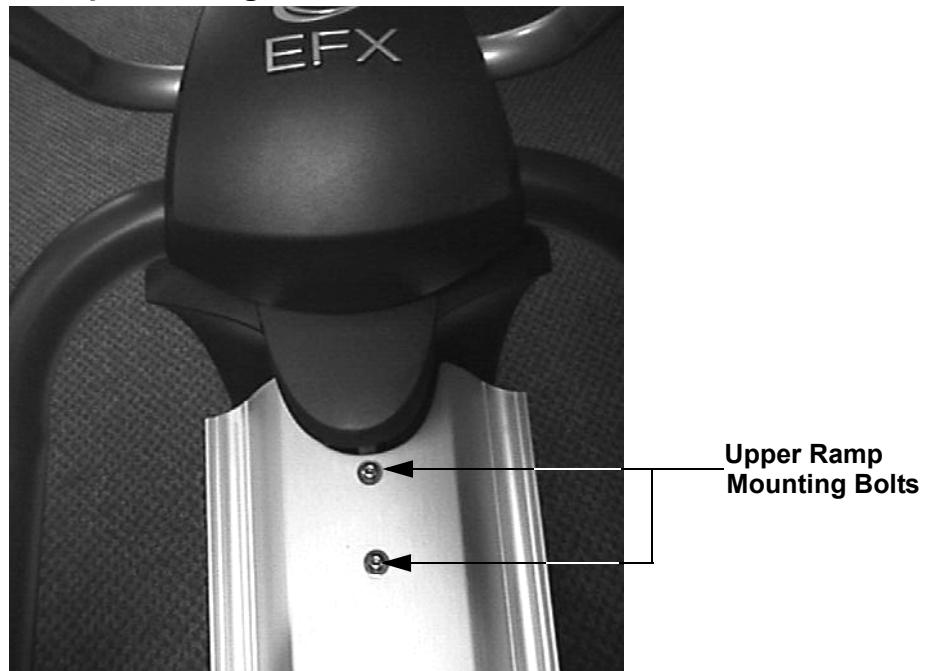

7. Rotate both stairarms forward and place them on the ramp tracks.
8. Replace the left and right rear covers per Procedure 7.15 and check unit operation as described in Section Four.

Procedure 7.14 - Replacing a Handlebar

1. Slide the lower handle bar boot up the handlebar to expose the lower handlebar mounting bolts.
2. Remove both of the lower handlebar mounting bolts. See Diagram 7.10.

Diagram 7.10 - Lower Handlebar Mounting

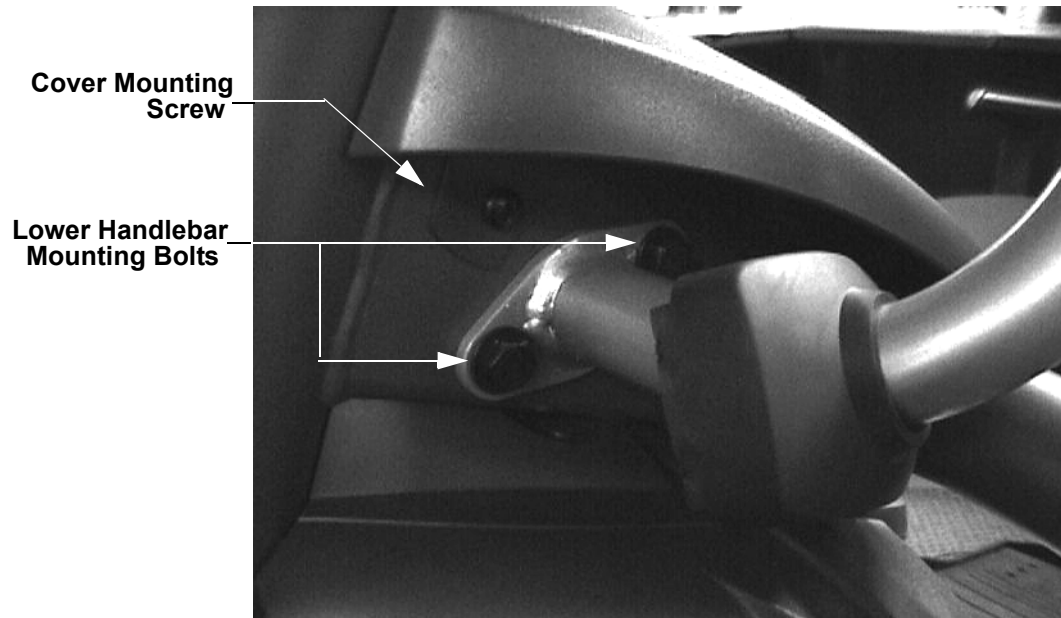

3. Remove the bolt that fastens the upper end of the handlebar in the handlebar clamp.
4. Slide the handlebar out of the handlebar clamp.
5. Set the replacement handlebar in its mounting position, and slide the handlebar into the handlebar clamp.
6. Align the lower end handlebar with its mounting holes. Hand start the lower handlebar mounting bolts removed in step 3.
7. Hand start the upper handlebar mounting bolt in the handlebar clamp.
8. Torque the lower handlebar bolts to 300 inch pounds and the upper handlebar bolt to 140 inch pounds.
9. Slide the handlebar boot into place so that it covers the lower handlebar mounting bolts.
10. Check unit operation as described in Section Four.

Procedure 7.15 - Replacing a Main Column

1. Procedure

1. Remove the rear cover and disconnect the red battery lead from terminal M6 of the lower PCA.
2. Attach the anti-static wrist strap to your arm, then connect the ground lead of the wrist strap to the EFX frame.
3. Remove the four screws that secure the display housing front panel to the display backing plate.
4. Disconnect the heart rate cable (connector J1) and upper interconnect cable (connector J5) from the upper PCA. Remove the display housing front panel.
5. Remove the four screws that fasten the display backplate to the upper main column. Remove the display housing backplate.
6. Pry the end cap out the front of the frame base tube with a thin bladed screwdriver (See Diagram 7.5).
7. Carefully withdraw both cables and mid-point connector. Disconnect the upper interconnect cable from the mid-point connector. Carefully draw the upper interconnect cable out of the upper end of the main column. Set the cable aside to be re-installed later.

Diagram 7.11 - Main Column

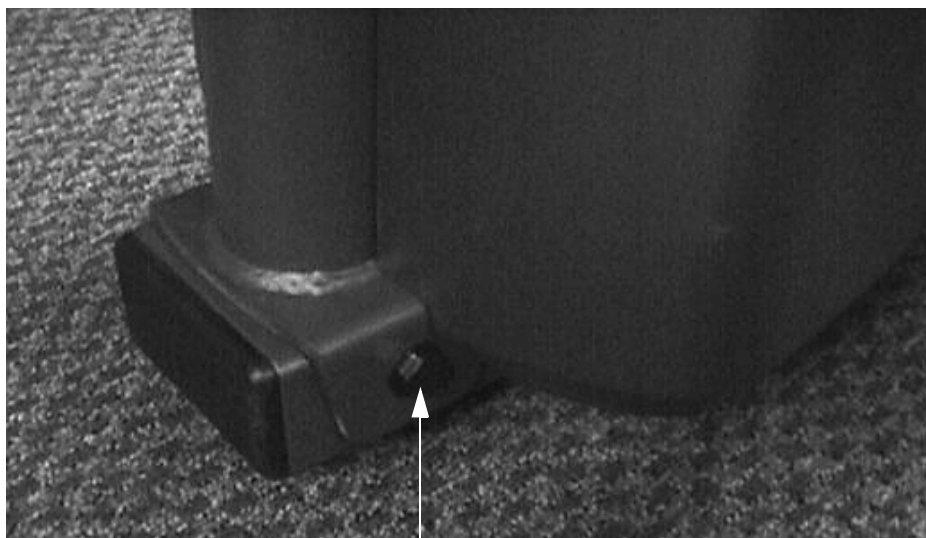

Lower Main Column
Mounting Bolt

8. Remove both handlebars per Procedure 7.14.
9. Remove the left and right frame tube per Procedure 7.24.
10. Remove the two bolts and washers that fasten the bottom of the main column to the frame base. See Diagram 7.11. Remove the main column.
11. Feed the upper interconnect cable into the replacement main column so that an end of the cable protrudes from both ends of the main column.
12. Set the main column at its mounting location with the lower end of the upper interconnect cable in the access hole in the frame base. Replace bolts and washers removed in step 12 and torque them to 240 in./lbs.
13. Replace the left and right frame tubes per Procedure 7.24.
14. Rotate the right hand handlebar with upper pivot into its mounting position. Thread the upper pivot into the main column and torque it to 100 ft./lbs.
15. Repeat the procedure in step 16 with the left hand handlebar and upper pivot.
16. Replace the cover with the hardware removed in step 8.
17. Connect the lower end of the upper interconnect cable to the mid-point connector. Careful push the mid-point connector and cables into the frame tube. Replace the end cap.
18. Feed the upper end of the upper interconnect cable through access hole in the display housing backplate. Set the display housing backplate at its mounting position and fasten it with the screws removed in step 5.
19. Connect the upper interconnect cable to the J5 connector on the upper PCA. Set the display housing front panel at its mounting location and fasten it with the hardware removed in step 3.
20. Replace the red battery lead removed in step 1 and check unit operation as described in Section Four.

Procedure 7.16 - Replace the Rear Cover

1. The rear cover is a four piece cover; front, top, left and right sections. If the front cover section is being removed, the frame cover must also be removed (See Diagram 7.12).
2. If you are removing either the right or left cover section, it is only necessary to remove the four screws that fasten the cover section.

Diagram 7.12 - Frame Cover

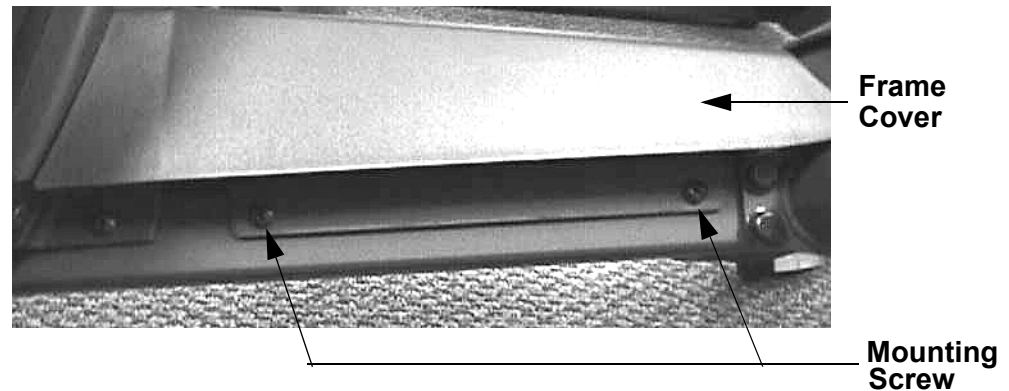

3. If you are replacing either the front or top cover section, you must first remove the left and right cover sections and then remove the cover section being replaced.
4. If you are removing the top cover (See Diagram 7.13), remove the two phillip screws that fasten the top cover section to the frame upright. Remove three screws that fasten the top cover section to the rear cover support. Remove two screws that fasten the top cover section to the front cover section.
5. If you are removing the front cover section, the right, left and top cover sections must be removed first. Remove the four screws that fasten the frame cover to the frame (See Diagram 7.13). Remove two phillips screws that fasten the bottom of the front cover section to the frame. Lift the rear portion of the frame cover and carefully remove the front cover section. If it is necessary to remove the frame cover, lift the rear of the frame cover, slide the frame cover out of the ramp and remove the frame cover.

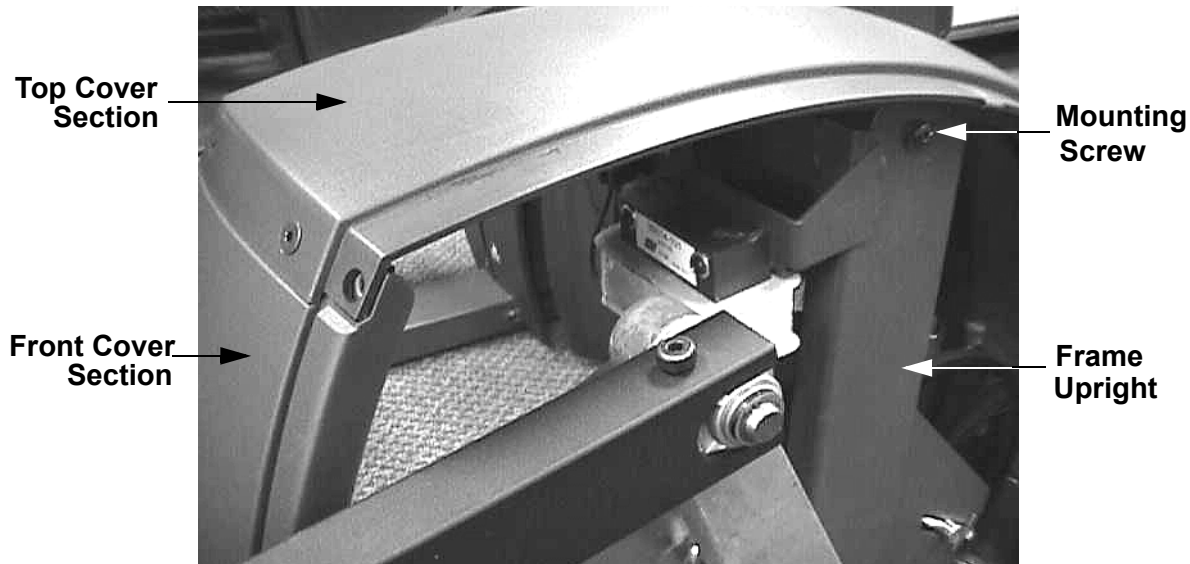
Diagram 7.13 - Top Cover Section (with right & left cover sections removed)

6. If all four cover sections have been removed, first replace the frame cover and front cover section, then the top cover section and then the left and right cover sections as described below.
7. Slide the tongue of the frame cover into the ramp. Lift the rear of the frame cover and fit the front cover against the frame cover. Slide the front and frame covers into place as a unit. Replace and tighten the four phillips screws that fasten the frame cover to the frame. Replace and tighten the two phillips screws that fasten the front cover section to the frame.
8. Set the top cover section in it's mounting position, replace and tighten the two phillips screws that fasten the top cover section to the frame upright. See Diagram 7.13. Replace and tighten the three screws that fasten the top cover section to the rear cover support. Replace and tighten the two screws that fasten the top cover section to the front cover section.
9. Set the left cover section in it's mounting position, replace and tighten the four screws that fasten the left cover section to the front cover section, top cover section and rear cover support.
10. Set the right cover section in it's mounting position, replace and tighten the four screws that fasten the right cover section to the front cover section, top cover section and rear cover support.

Procedure 7.17 - Replacing a Load Resistor

Warning

When the EFX is operated the load resistors get very hot. Be sure to allow the load resistors enough time to cool before continuing with this procedure.

1. Remove the rear cover and disconnect the red battery lead from terminal M6 of the lower PCA.
2. Remove the three screws that fasten the load resistor assembly and shield to the frame upright. Rotate the load resistor assembly 180 degrees and set it on the top of the frame upright. See Diagram 7.14.

Diagram 7.14 - Load Resistor Assembly

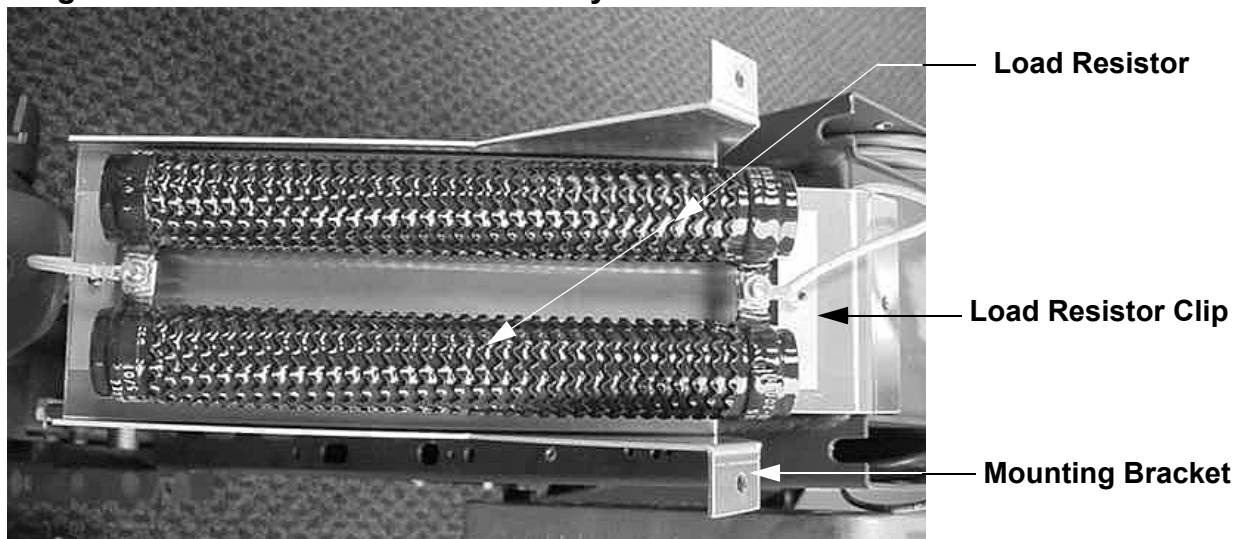

3. Remove the screws that fasten the load resistor wiring from both terminals of the resistors.
4. Remove the screw that fastens one of the load resistor clips to the mounting bracket. Remove the resistor(s) being replaced.
5. Slide the replacement resistor into its mounting position so that its terminals contact the terminals of the other load resistor. Slide the load resistor clip, removed in step 4 into the opposite end of both resistors and fasten the load resistor clip to the mounting bracket with the screw removed in step 4.
6. Reconnect the load resistor wiring removed in step 3. When complete the resistors should be connected to each other with a load resistor wire connected to each terminal of the resistors.
7. Rotate the load resistor assembly back into its mounting position with the shield between the load resistor and the frame upright. Fasten the load resistor assembly and shield to the

frame upright with the screws removed in step 2.

8. Route the load resistor wires into the slots at the top of the frame upright. This will keep the wires away from all moving parts, such as the stairarms.
9. Reconnect the red battery lead removed in step 1 and replace the cover.
10. Replace the red battery lead removed in step 1 and check unit operation as described in Section Four.

Procedure 7.18 - Replacing a Generator (C524, only)

WARNING

When the unit is used, stairarms are in motion or the generator is rotated by any means, the generator will produce potentially hazardous voltages even when the battery is disconnected.

1. Remove the rear cover and disconnect the red battery lead from terminal M6 of the lower PCA.
2. Disconnect the generator output cable from the lower PCA, terminals AC1, AC2 and AC3.

Diagram 7.15 - Generator Mounting

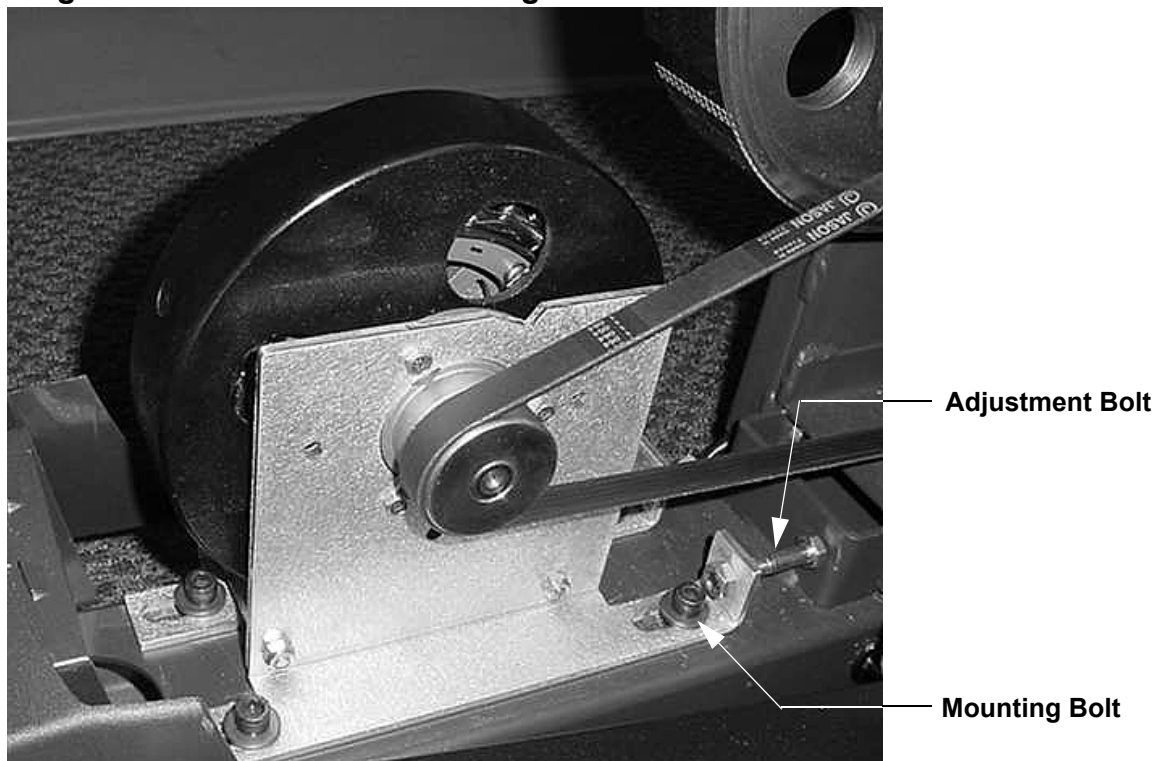

3. Remove the four mounting bolts that fasten the generator to the frame. remove the generator belt from the generator. Remove the generator adjustment bolt from the generator. See Diagram 7.15.
4. Mount the adjustment bolt in the replacement generator with a nut on each side of the generator bracket.
5. Set the generator in its mounting position and hand start the four mounting bolts removed in step 5 so that the bolts are as far in as possible while still allowing the generator to slide on its mounting slots. Using the rearward nut on the adjustment bolt tension the generator belt to 60 pounds, refer to Procedure 5.3. See Diagram 7.15.

6. When the generator belt tension is correct, torque the four generator mounting bolts to 150 inch pounds. Securely tighten the forward nut on the adjustment bolt.
7. Reconnect the red battery lead removed in step 1 and replace the rear cover.
8. Check the operation of the EFX as described in Section Four.

Procedure 7.19 - Replacing a Generator (C524i, only)

WARNING

When the unit is used, stairarms are in motion or the generator is rotated by any means, the generator will produce potentially hazardous voltages even when the battery is disconnected.

1. Remove the rear cover and disconnect the red battery lead from terminal M6 of the lower PCA.
2. Remove the three generator mounting screws shown in Diagram 7.16.
3. Remove the two bearing clamp screws shown in Diagram 7.17. Remove the bearing clamp.
4. Lift the generator and remove its drive belt.
5. Loosen all four generator mounting nuts. Loosen the locking nut on the generator's adjustment bolt and thread the adjustment bolt into tab to remove tension from the generator's drive belt. Remove the drive belt from the generator's pulley.
6. Remove the four generator mounting nuts. Disconnect the generator's cable connector from the intermediate cable and remove the generator from the EFX.
7. Remove the adjustment bolt and its locking nut from the generator's mounting base.
8. Thread the adjustment bolt and locking nut into the tab on the replacement generator.

Diagram 7.16 - Generator Mounting



9. Set the replacement generator at its mounting position. Remove the three generator mounting screws, the two bearing clamp screws and the bearing clamp. Lift the generator and place the drive belt around the generator's pulley.

Diagram 7.17 - Generator Bearing Clamp

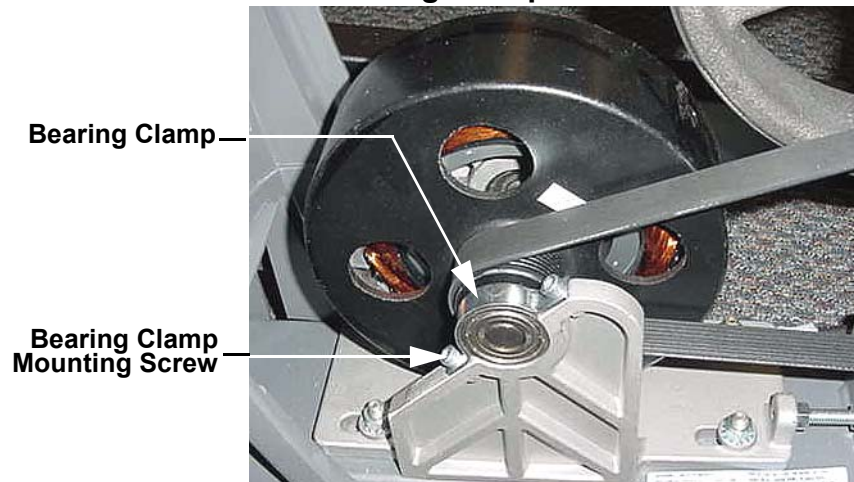

10. Replace and tighten the three generator mounting screws removed in step 9. Set the bearing clamp in its mounting position, replace and tighten the two bearing clamp mounting screws removed in step 9.
11. Hand start, but do not tighten the four mounting nuts removed in step 6. The generator must be able to move in order to adjust the belt tension.
12. Adjust the generator drive belt tension per Procedure 5.3.
13. Reconnect the red battery lead removed in step 1 and replace the rear cover.

Check the operation of the EFX as described in Section Four.

Procedure 7.20 - Replacing a Battery (C524, only)

1. Remove the rear cover
2. Disconnect the red battery lead from terminal M6 of the lower PCA and the black battery lead from M7 of the lower PCA. See Diagram 7.5.

Diagram 7.18 - Lower PCA, Battery Assembly (with battery wires disconnected)

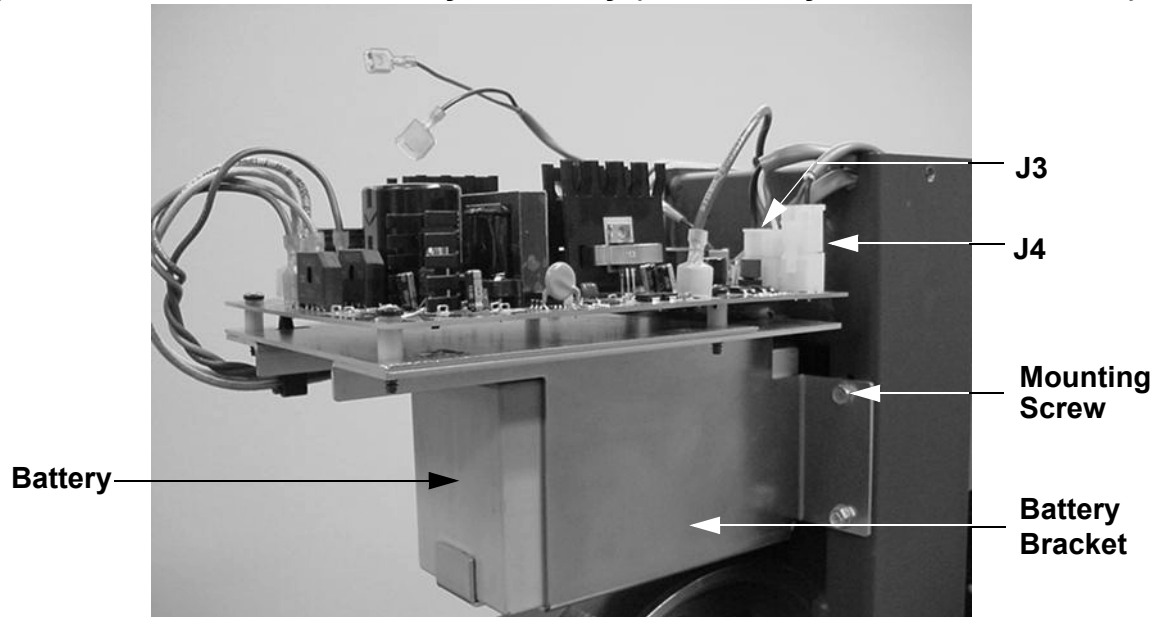

3. Disconnect the J3 and J4 connectors from the lower PCA.
4. While supporting the lower PCA and battery assembly remove the four screws that fasten the battery bracket to the frame upright.
5. Swing the lower PCA and battery assembly away from the frame upright and slide the battery out of the battery bracket.
6. Remove the red and black wires from the battery and connect them to the replacement battery as follows: the red wire to the positive (+) battery terminal and the black wire to the negative (-) terminal. **Note:** There is a red dot next to the positive terminal of the battery. See Diagram 7.18.

Diagram 7.19 - Battery Wiring

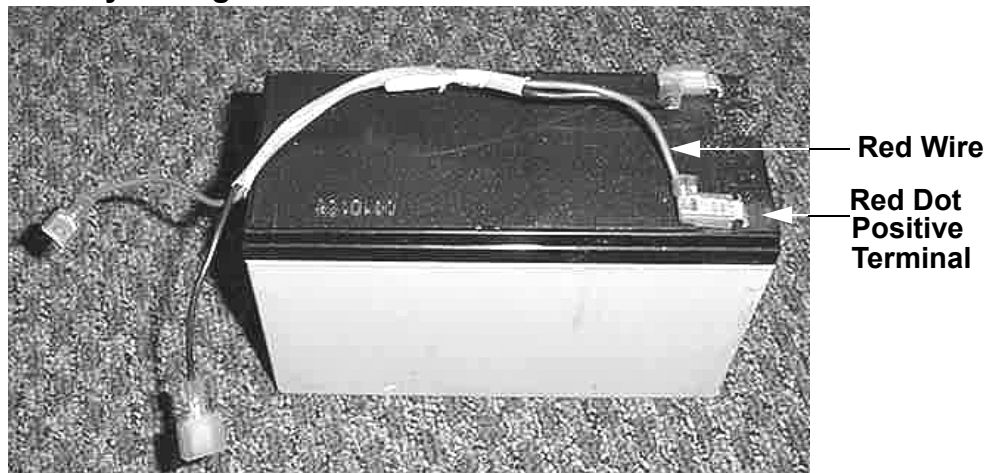

7. Slide the replacement battery into the battery bracket with the battery terminals nearest to the open end of the battery bracket.
8. Fasten the lower PCA and battery assembly to the frame upright with the screws removed in step 4.
9. Reconnect the J3 and J4 connectors to the lower PCA.
10. Reconnect the black battery lead to terminal M7 of the lower PCA. Reconnect the red battery lead to terminal M6 of the lower PCA.
11. Replace the rear cover.
12. Check the operation of the EFX as described in Section Four.

Procedure 7.21 - Replacing a Battery (C524i, only)

1. Remove the entire rear cover, including the front section of the cover.
2. Disconnect the red battery lead from terminal M6 of the lower PCA and the black battery lead from M7 of the lower PCA of the lower PCA. Refer to Diagram 7.20.

Diagram 7.20 - Lower PCA, Battery Assembly

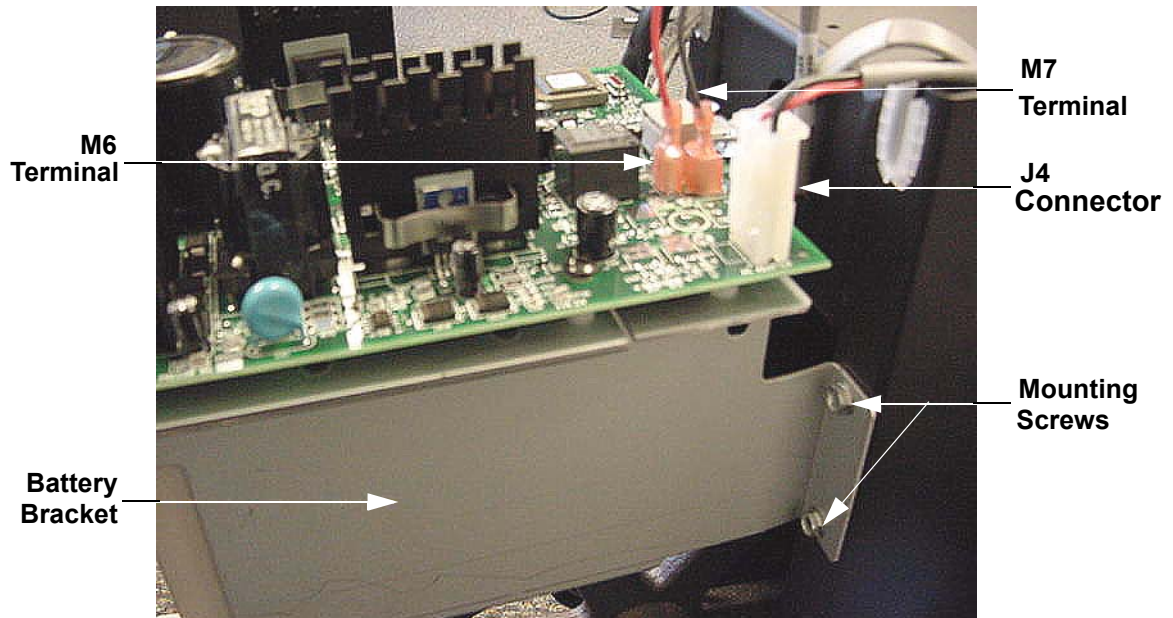

3. Disconnect the J1 (generator cable), J2 (data cable), J3 (lift cable), J4 (power adapter), M1 and M2 load cables from the lower PCA.
4. Use an antistatic wrist connect to a grounding point when performing steps 5, 6, 11 and 12.
5. Remove the four screws fastening the lower PCA to the battery bracket and remove the lower PCA and place it on a static safe surface.
6. Carefully remove the red and black wires from the battery. Ensure that the battery terminals have not been bent upward and then place a piece of electrical tape over both battery terminals. The battery is going to be slid out of the battery bracket and the battery terminals can not be allowed to touch the upper metallic surface of the battery bracket.

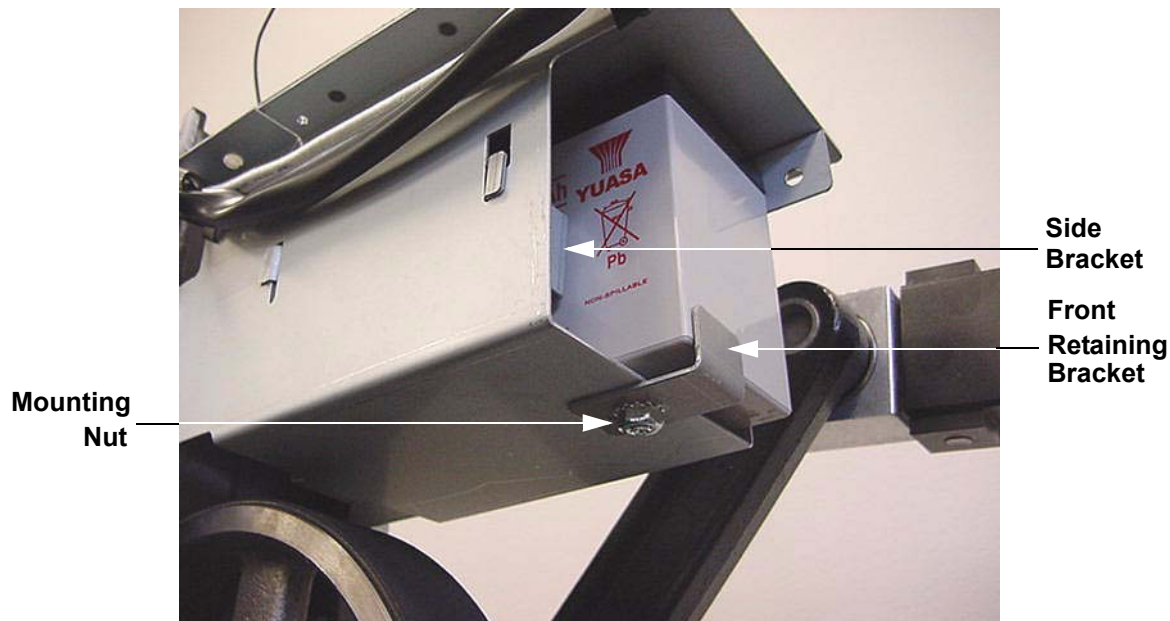
Diagram 7.21 - Battery Bracket, Front Retaining Bracket

7. Remove the nut fastens the front battery retaining bracket. Refer to Diagram 7.18. Carefully, slide the battery out of the battery bracket.
8. Remove the red and black wires from the replacement battery. Place a piece of electrical tape over each of the battery terminals. Ensure that the side bracket is correctly in place in the slots in the battery bracket and carefully slide the battery into the bracket.
9. Replace the front retaining bracket and fasten it with its mounting nut.
10. Remove the electrical tape from the battery terminals and reconnect the battery wires as follows: the red wire to the positive (+) battery terminal and the black wire to the negative (-) terminal. **Note:** There is a red dot next to the positive terminal of the battery.
11. Set the lower PCA in its mounting position and fasten it with the screws removed in step 5.
12. Reconnect the lower PCA wiring as follows: power adapter cable to J4, generator cable to J1, data cable to J2, lift cable to j3, load wires to terminals M1 and M2 (either wire may be connected to either the M1 or M2 terminal).
13. Replace the rear cover. Check the operation of the EFX as described in Section Four.

Procedure 7.22 - Replacing a Power Input Jack Assembly

1. Remove the rear cover and disconnect the red battery lead from terminal M6 of the lower PCA.
2. Disconnect the J4 connector from the lower PCA. See Diagram 7.18.

Diagram 7.22 - Power Input Jack Mounting

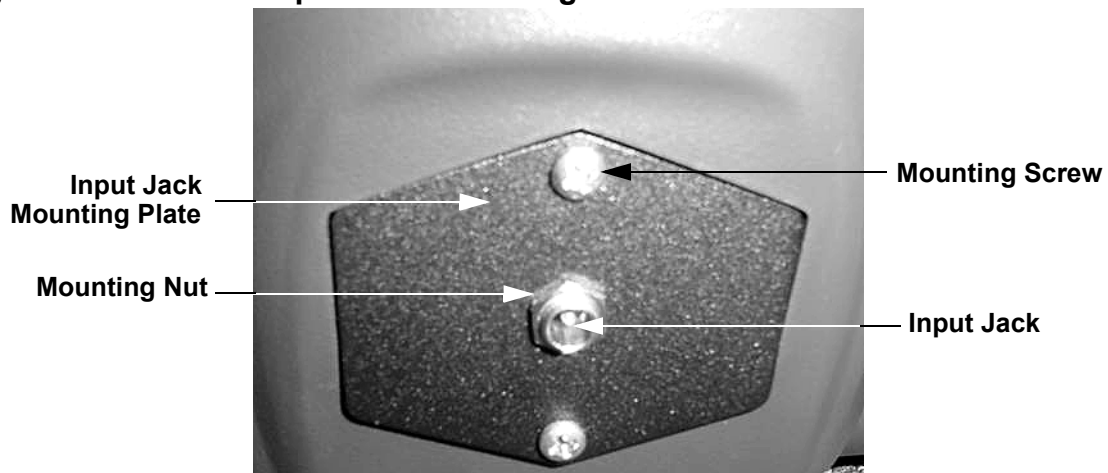

3. Remove the screws that fasten the power input jack mounting plate to the rear cover support. See Diagram 7.19.
4. Remove the power input jack mounting plate with the power input jack assembly from the unit.
5. Remove the nut that fastens the power input jack to the power input jack mounting plate. Remove the power input jack from the power input jack mounting plate.
6. Fasten the replacement power input jack to the power input mounting with the mounting nut provided with the power input jack.
7. Feed the power input jack wiring through the hole in the rear cover support and mount the power input jack mounting plate with the screws removed in step 3.
8. Route the power input jack wiring to the lower PCA. Connect the plug on the power input jack wiring to the J4 connector on the lower PCA.
9. Reconnect the red wire battery lead, removed in step 1, to the positive (+) terminal of the battery.
10. Replace the rear cover.

11. Replace the red battery lead removed in step 1 and check unit operation as described in Section Four.

Procedure 7.23 - Replacing a Lift Motor

1. Remove the left rear cover and disconnect the red battery lead from terminal M6 of the lower PCA.
2. Remove both front covers. Carefully, extract the lift motor cable from the frame access hole and disconnect the lift motor cable from the lift intermediate cable.
3. Remove the four screws that fasten the lift motor yoke into the ramp.
4. Carefully, slide the lift motor yoke out of the ramp and lower the ramp until it is resting on the frame.
5. Remove the nut, washer and bolt that fasten the lower end of the lift motor to the frame and remove the lift motor assembly from the EFX.
6. Remove the nut and bolt from the end of the lift motor drive screw. Thread the lift motor yoke assembly off of the lift motor drive screw. See Diagram 5.4.
7. Thread the lift yoke assembly, removed in step 6, onto the replacement lift motor's drive screw.
8. Install the nut and bolt, removed in step 6, into the end of the replacement lift motor's drive screw.
9. Mount the lift motor to the EFX frame with the nut, washer and bolt removed in step 5.
10. Calibrate the lift motor per Procedure 5.4.
11. Replace both front covers.
12. Reconnect the red battery lead to terminal M6 of the lower PCA. Replace the rear cover.
13. Check the operation of the EFX as described in Section Four.

Procedure 7.24 - Replacing a Frame Tube

Procedure

1. Remove the two screws that fasten the cover near the middle of the main column. Remove the cover.
2. Remove the four bolts and washers that fasten the lower end of the frame tube to the frame base.

Diagram 7.21 - Frame Tube Mounting



Upper Mounting Bolt

Lower Mounting Bolt

3. Remove the four bolts and washers that fasten the upper end of the frame tube to the main column. Remove the frame tube.
4. Set the replacement frame tube at its mounting position and hand start the bolts with washers at the upper end of the frame tube. Hand start the bolts with washers at the lower end of the frame tube. Torque the upper front two bolts to 300 in./lbs., the upper rear bolts to 240 in./lbs. and the lower four bolts to 300 in./lbs. See Diagram 7.20.
5. Set the cover in its mounting and fasten it with the two screws removed in step 1.
6. Check unit operation as described in Section Four.

Procedure 7.25 - Replacing a Stairarm Pivot Block

Warning: Care must be taken when work is being performed in the area of the stairarms. Pinch points exist between the stairarm and ramp and between the stairarm and crankarm, when the rear covers are removed.

Procedure

WARNING

Before continuing with this procedure, review the Warning and Caution statements listed in Section One, Things You Should Know.

1. Remove the left and/or right cover sections as described in Procedure 7.20.
2. Remove the mounting bolt and nut that fastens the stairarm pivot block to the stairarm. (See Diagram 7.22)
3. Slide the stairarm off of the stairarm pivot block.
4. Remove the stairarm pivot block retaining ring from the crankarm pin. Slide the stairarm pivot block off of the crankarm pin. If the stairarm pivot block is being replaced because of excessive wear, check the condition of the crank arm pin, it may be necessary to replace the crankarm.

Diagram 7.22 - Stairarm Mounting

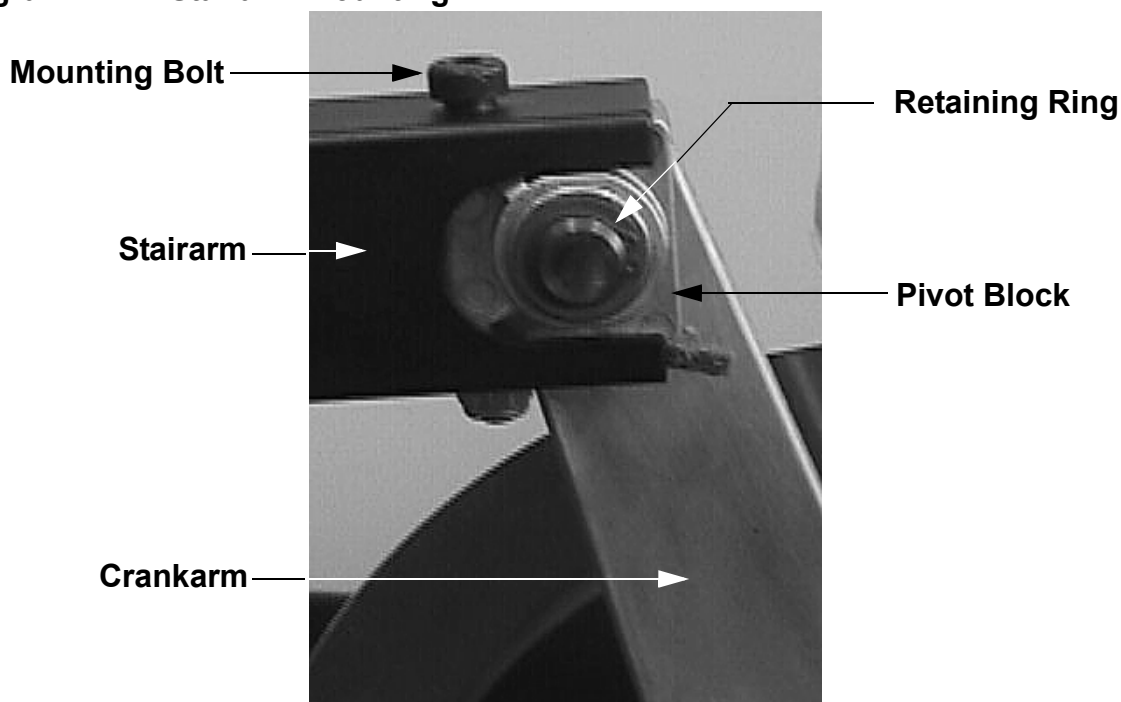

5. Slide the stairarm pivot block onto the crankarm pin and replace the retaining ring removed in step 4.
6. Slide the stairarm onto the stairarm pivot block. Install and hand tighten the stairarm pivot block mounting hardware. Torque the stairarm pivot block mounting bolt to 15 ft./lbs.
7. Replace the left and/or right cover sections per Procedure 7.18.

Procedure 7.26 - Replacing a Ramp Mounting Bracket

Warning: Care must be taken when work is being performed in the area of the stairarms. Pinch points exist between the stairarm and ramp and between the stairarm and crankarm, when the rear covers are removed.

Procedure

1. Remove the front, top, left and right rear cover sections per Procedure 7.15.
2. Rotate both stairarms to the rear, so that they are resting on the floor to the rear of the EFX.

Diagram 7.23 - Ramp Mounting Bracket

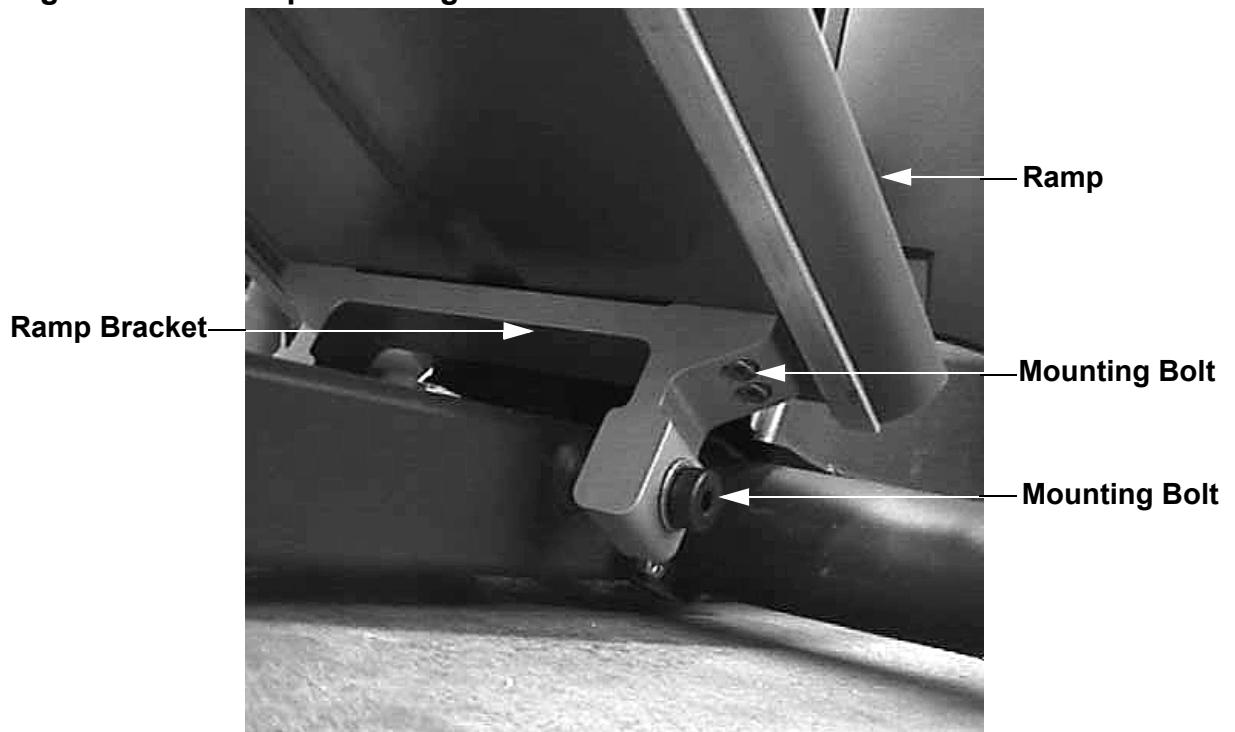

3. Remove the four bolts that fasten the ramp to the rear ramp bracket.
4. Remove the four bolts that fasten the lift yoke to the ramp.
5. Slide the ramp off of the lift yoke and remove the ramp from the EFX.
6. Remove the two bolts, wave washers and shims that fasten the ramp mounting bracket to the frame. Remove the ramp mounting bracket from the frame.

7. Set the replacement mounting bracket at its mounting position on the frame. Apply blue loctite to the ramp mounting bolts removed in step 6. Slide the wave washers onto the mounting bolts and then the shims. Hand start the ramp mounting bolts and then torque them to 35 ft./lbs.
8. Slide the ramp onto the lift yoke and set it at its mounting position on the ramp mounting bracket.
9. Replace and torque the four bolts that fasten the ramp to the rear ramp bracket to 12 ft./lbs.
10. Apply a coat of blue loctite to the lift yoke bolts. Replace and tighten the lift yoke bolts.
11. Rotate both stairarms forward so that they are resting on the ramp.
12. Replace the front, top, left and right cover sections per Procedure 7.15.
13. Check unit operation as described in Section Four.

Procedure 7.27 - Replacing the PROM

Anti-static kits (part number 20024-101) can be ordered from Precor.

1. The PROM and the associated printed circuit assembly (PCA) are static sensitive. Anti-static devices must be used and all anti-static precautions must be followed during this procedure.
2. Remove the printed circuit assembly per its associated procedure.
3. Currently we are using two styles of IC software packages. they are a 28 pin dual in line package (DIP28) and a forty-four pin square package (PLCC44). Each of these packages should be removed with a proper IC removal tool (see the illustrators below)

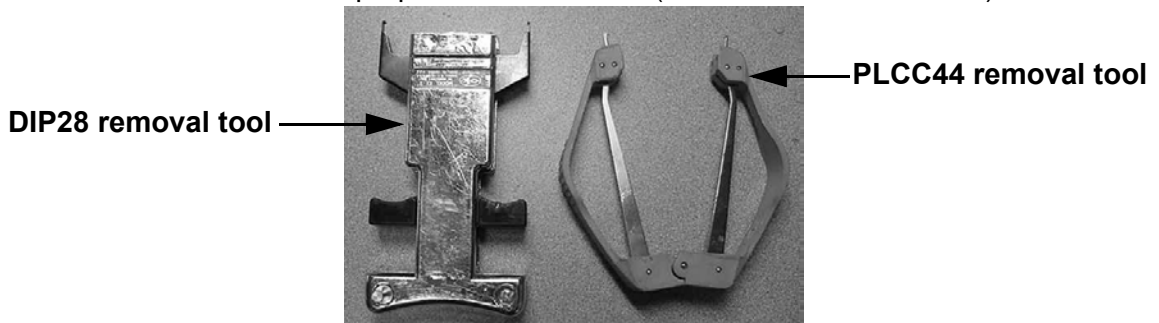

4. The IC's may inserted into their socket by hand by carefully aligning the notch on the IC with the notch on the IC socket and carefully pressing the IC into its socket. See the illustrations below for the alignment notches. Care must be taken that the IC legs on a DIP28 are all aligned in the socket to prevent the legs from bending when inserted. The PLCC44 IC must be carefully aligned squarely in its socket or it will not insert. Do not force the IC into its, socket. If it does not insert easily, remove the it and re-align it in its socket.

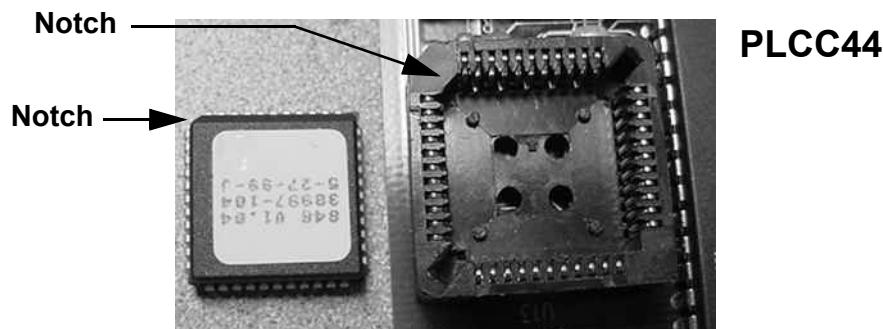
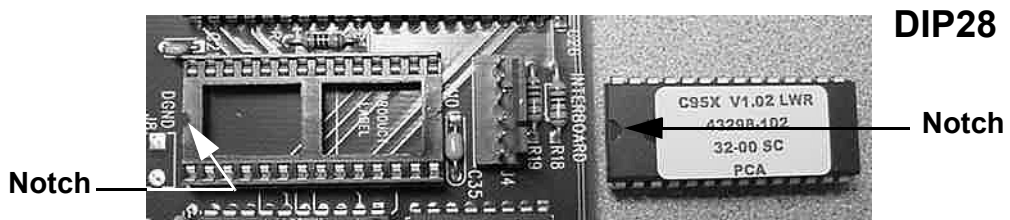

Wiring Diagram 8.1 - C524 Self Powered

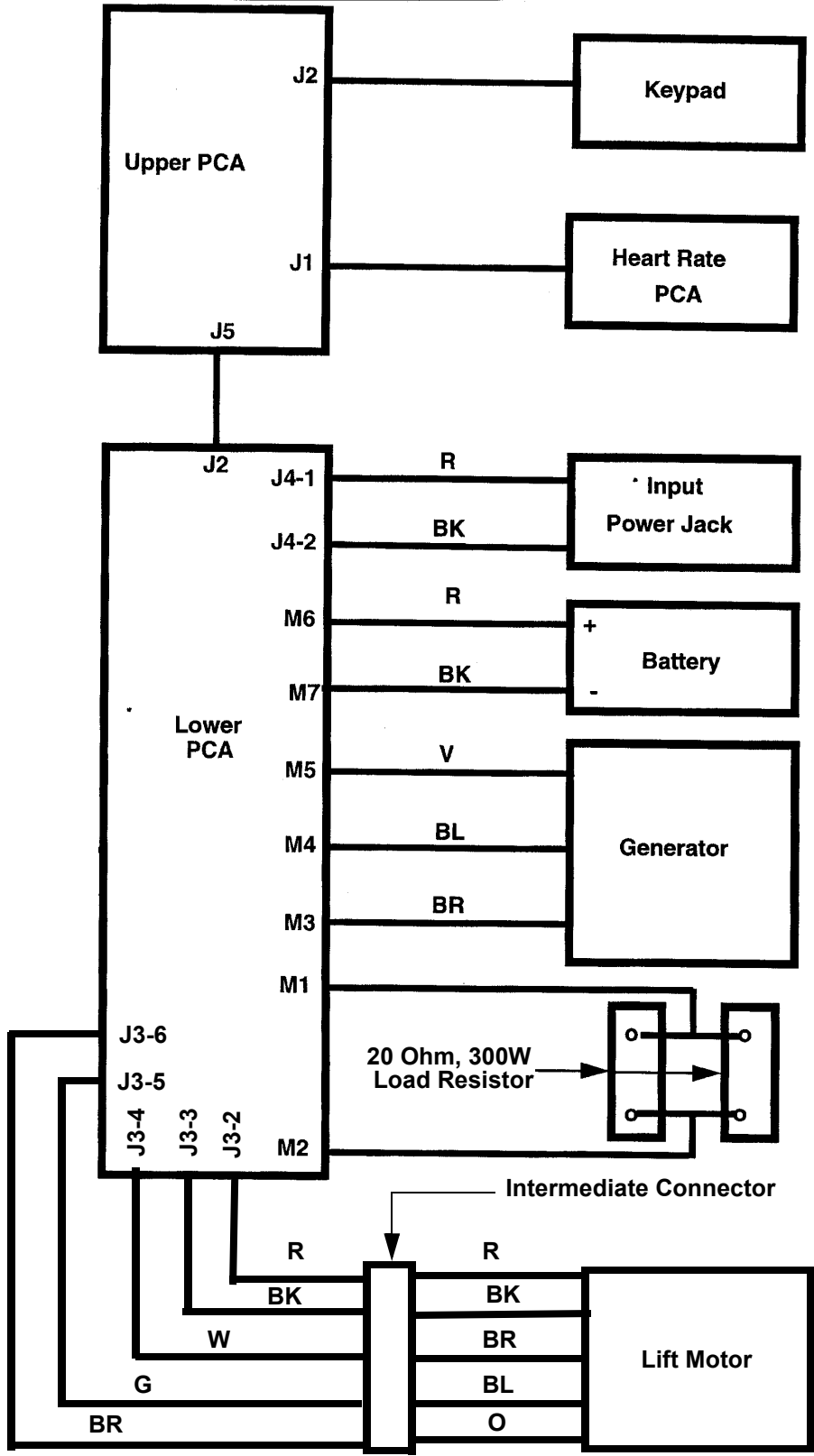

Block Diagram 8.2 - C524 Self Powered

PRECOR
USA

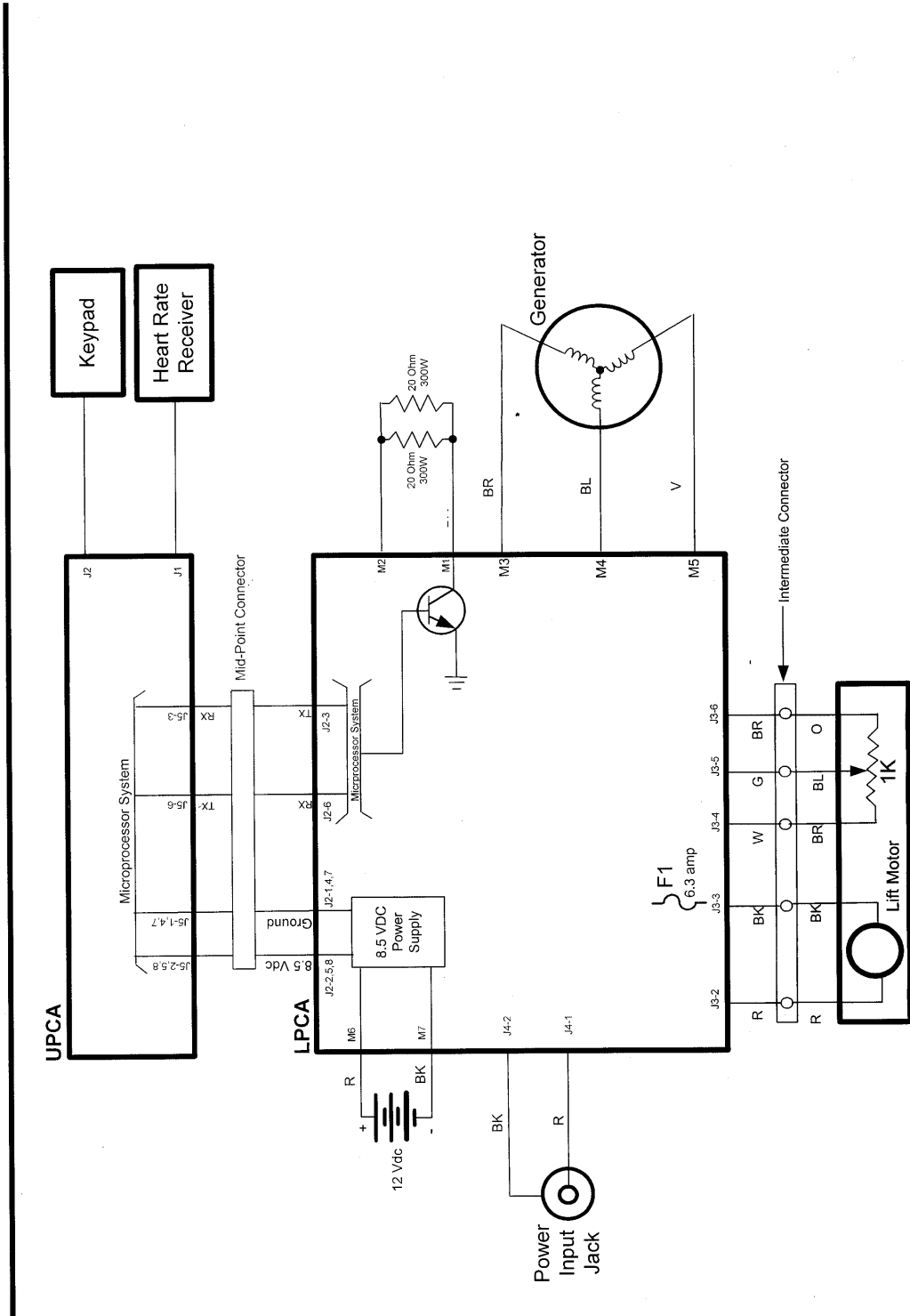

Wiring Diagram 8.3 - C524i Self Powered

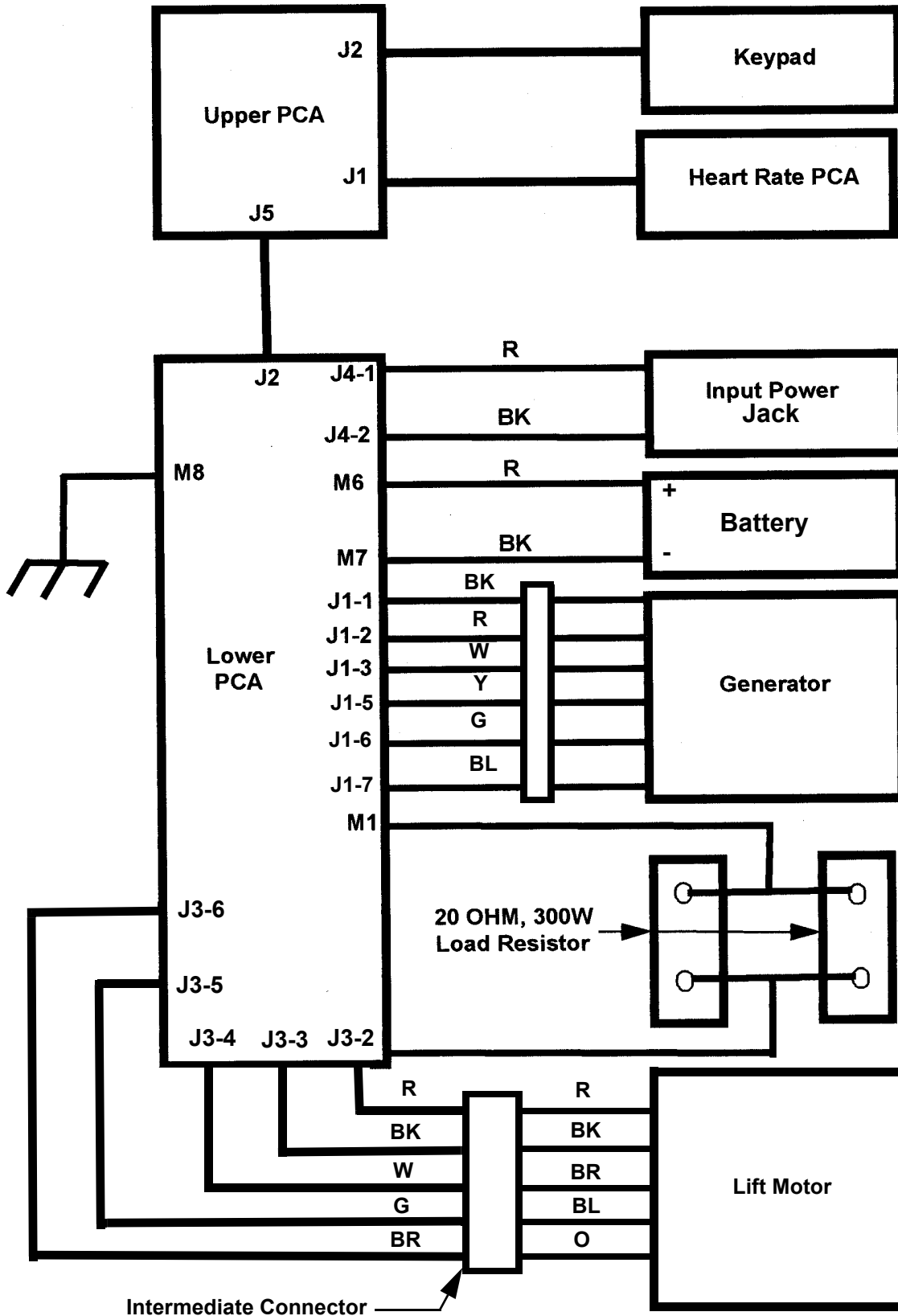

Block Diagram 8.4 - C524i Self Powered



C524i Self Powered EFX

