

Nautilus *Health & Fitness Group*

**StairMaster[®]
ClubTrack[®] Treadmills**

**User's Guide
for the**

**2100 LE Treadmill
2100 LC Treadmill**



StairMaster[®]
THE RESULTS YOU WANT[™]



**StairMaster is a division of
Nautilus Health & Fitness Group
Corporate Headquarters**

1886 Prairie Way
Louisville, CO 80027

(800) 864-1270
(303) 939-0100
Fax (800) 898-9410
www.stairmaster.com

Printed in the United States.

© 2003 StairMaster® Health & Fitness Products, Inc.
All rights reserved.

P/N 27483 Rev A

TABLE OF CONTENTS:

<i>SAFETY REQUIREMENTS</i>	5
<i>UNPACKING and INSTALLATION INSTRUCTIONS</i>	7
Accessories and Options	7
How to Reach Us	7
<i>Guidelines For Getting ON and OFF the Treadmill</i>	8
<i>LIMITED-ACCESS CONTROL</i>	9
Activation	9
Deactivation	9
Magnetic Key as an Emergency Stop	9
<i>HEART RATE MONITORING</i>	10
Telemetry Heart Rate	10
Contact Heart Rate	11
<i>EXERCISE INTENSITY, FREQUENCY, & DURATION</i>	12
Intensity	12
Frequency and Duration	12
<i>OPERATING THE CLUBTRACK 2100LE/2100LC TREADMILL</i>	14
Turning on the Power	14
Understanding the Controller	14
Controller Displays and Keys	15
ClubTrack 2100 LC Display Windows	15
ClubTrack 2100 LE Display Windows	15
Numeric keypad	17
Incline UP [↑] / DOWN [↓] Keys	17
Speed FASTER [+] / SLOWER [-] Keys	18
Start Key	18
Cool Down Key	18
Stop Key	18
Display LOCK / UNLOCK - Statistics Key	19
Remote Operation Controls (ROC)	20
Workout Program Keypad	20
The Quick Start Program	21
The Manual Program	22
The Fat Burner Program	23
The Calorie Burner Program	24

The Speed Intervals Program	26
Heart Rate (HR) Zone Trainer Program.....	28
The Advanced Programs.....	30
StairMaster Fit Test	32
FireFighter Fitness Test.....	34
Custom Speed Interval Program	36
HR Control Interval Program	38
5K Fun Run Program.....	41
10K Bolder Boulder Run Program.....	42
Custom Calorie Burn Program	43
9-Hole Walk Program.....	44
Options During a Workout.....	45
Changing Speed, Incline or Target Heart Rate During a Workout	45
Pausing Your Workout	46
COOL DOWN	46
Console Key Functions in Cool Down State	47
End of Your Workout.....	47
Auto Reset	47
<i>Instruction Page.....</i>	<i>48</i>
Using the ClubTrack® 2100 Treadmill.....	48
<i>Heart Rate Priority on ClubTrack 2100 Treadmills.....</i>	<i>49</i>
<i>Error Codes.....</i>	<i>50</i>
<i>Viewing Maintenance Information</i>	<i>50</i>
<i>Changing the Workout Default Values.....</i>	<i>51</i>
<i>Customizing the Treadmill.....</i>	<i>52</i>
<i>Maintenance</i>	<i>53</i>
Cleaning	53
Treadmill Interior	53
Treadmill Belt Adjustments.....	54
Belt Tension	54
Belt Tracking	55
Belt Replacement	55
Moving and Storing the Treadmill.....	56
<i>Troubleshooting.....</i>	<i>56</i>
IMPORTANT PHONE NUMBERS	57

SAFETY REQUIREMENTS

WHEN USING ELECTRICAL EQUIPMENT, ALWAYS FOLLOW THESE BASIC PRECAUTIONS:

IMPORTANT SAFETY INSTRUCTIONS

The following definitions apply to the words "Danger" and "Warning" found throughout this manual:

DANGER - Used to call attention to IMMEDIATE hazards which, if not avoided, will result in immediate, serious personal injury or loss of life.

WARNING - Used to call attention to POTENTIAL hazards that could result in personal injury or loss of life.

READ ALL INSTRUCTIONS BEFORE USING THE MACHINE.

DANGER To reduce the risk of electrical shock, always unplug the external power supply from the electrical outlet before cleaning, maintaining, or repairing.

WARNING To reduce the risk of burns, electric shock, or injury to persons:

Read this manual in full before operating the treadmill. Failure to follow these guidelines can produce a serious or possibly fatal electrical shock hazard or other serious injury. Consult a qualified electrician as required.

1. The controller Power key does not turn off the electrical current to the treadmill. The treadmill continues to draw power, even when the controller is off. To avoid electric shock, do not remove treadmill hood or place hands beneath the treadmill while the treadmill is plugged into a power source.
2. Do not start the treadmill when someone else is standing on the belt.
3. Keep speed and incline at the lowest settings when someone is getting on and off the treadmill.
4. Keep the area underneath and around the treadmill clear.
5. Before each use of this equipment, check the power receptacle for signs of damage. Do not operate the equipment if the integrity of this item is in question.

SAFETY REQUIREMENTS (continued)

6. To avoid potential safety and electrical problems, replace with manufacturer's specified parts only.
 - **IMPORTANT:** Replace the drive belt with a StairMaster specified drive belt (P/N 27458). Failure to do so could create hazardous leakage currents without the correct part.
7. This equipment is classified Class I, Type B, ordinary equipment. Not protected against fluid ingress. Rated for continuous operation. Do not operate this equipment in the presence of flammable anesthetic mixtures.
8. Do not let liquid enter the controller. If it does, the controller must be inspected and tested for safety by an approved technician before it can be used again.
9. Increased risk due to leakage current can result if this equipment is not grounded properly.
10. The treadmill must be on an appropriate, dedicated electrical circuit. Nothing else should be connected to the circuit.
11. Incorrect installation by unauthorized personnel can lead to equipment damage and may void the warranty.
12. Do not stand on treadmill hood or front trim cover.
13. Close supervision is necessary whenever the machine is used by or near children, invalids, or disabled persons.

Failure to follow the conditions set forth below shall limit, to the extent allowed by law, StairMaster Health & Fitness Products, Inc. responsibility for the safety, reliability, and performance of this equipment.

- The operator manual must be read in full by each owner and trainer before the product is first used. Each user must be instructed in the proper use of the treadmill and its accessories.
- Assembly operations, extensions, readjustments, modifications, or repairs must be carried out only by StairMaster-trained or StairMaster-authorized personnel.
- Do not remove the treadmill hood: dangerous voltages are present. Components are serviceable only by qualified service personnel.
- The electrical wiring within the treadmill setting and the electrical installation of the treadmill must comply with the applicable local or provincial requirements.
- The equipment must be used in accordance with the instructions for use.

SAVE THESE INSTRUCTIONS

UNPACKING and INSTALLATION INSTRUCTIONS

Please refer to the Treadmill Unpacking & Installation Instructions that shipped with the treadmill. These instructions provide information regarding receiving your order, site requirements, unpacking and installation steps, and testing the treadmill and controller.

The treadmill and controller must be installed correctly before being used. StairMaster® recommends that you contact your treadmill dealer or sales representative when your equipment arrives. The representative will help unpack, install, and demonstrate it, to ensure that:

- The equipment is free from shipping damage.
- The treadmill is connected correctly to the appropriate AC power source.
- Installation and operation are in accordance with StairMaster standards.

Incorrect installation by unauthorized personnel can lead to equipment damage and may void the warranty.

WARNING

THE TREADMILL MUST BE ON A DEDICATED BRANCH CIRCUIT.
NO OTHER DEVICE SHOULD BE CONNECTED TO THAT CIRCUIT.
EXCESSIVE RISK CURRENT (LEAKAGE) CAN RESULT IF THE EQUIPMENT IS NOT
PROPERLY GROUNDED.
FAILURE TO FOLLOW THESE GUIDELINES WILL PRODUCE A SERIOUS OR POSSIBLY
FATAL ELECTRICAL SHOCK HAZARD.
CONSULT A QUALIFIED ELECTRICIAN AS REQUIRED.

Accessories and Options

An operator manual (P/N 27483) is shipped with each treadmill. The following options are available:

Part No.	Description
36147-001	Left Handrail Kit
36147-002	Right Handrail Kit
36147-003	Left and Right Handrails
34198-003	Transmitter Belt with strap (HRM)

- To avoid potential safety and electrical problems, use parts and accessories that meet StairMaster specifications.

How to Reach Us

For Technical Assistance / Parts:

North America: 800-331-3578
International: 800-864-1270 x1603

See addresses and phone numbers listed at the end of this manual.

Guidelines For Getting ON and OFF the Treadmill

Instruct each user in the following guidelines for getting on and off the treadmill.

- The walking belt should be moving at minimum speed before the user steps onto the treadmill.
1. Stand next to the treadmill and place both hands on the front handrail.
 2. Straddle the walking belt or step onto the side of the deck. Step onto the moving belt and begin walking.
 3. (Optional) To get the feel of the moving belt, place the foot nearest the treadmill on the walking belt and let it move backwards. Lift it and repeat several times until comfortable with the treadmill speed.
 4. When walking comfortably on the treadmill, let go of the handrail.
 5. While walking on the treadmill:
 - Face forward. Avoid looking down at the walk belt.
 - Maintain speed by keeping a consistent distance from the handrail.
 - Adjust the speed and incline as required. Hold the handrail as the speed and incline change.
 6. Before stepping off the treadmill, place one hand on the handrail, wait for the belt to stop, then step off.

LIMITED-ACCESS CONTROL

Limited-access control lets you restrict treadmill use to authorized personnel. It also lets you stop the treadmill in an emergency. The magnetically-activated control is located on the front of the handrail, just below the STOP key. The limited-access control is deactivated on machines shipped from the factory.

Activation

To activate the limited-access control and restrict access, place the magnetic key supplied with the treadmill in the designated area in the front handrail so that the StairMaster trademark "S" logo on the key faces the user.

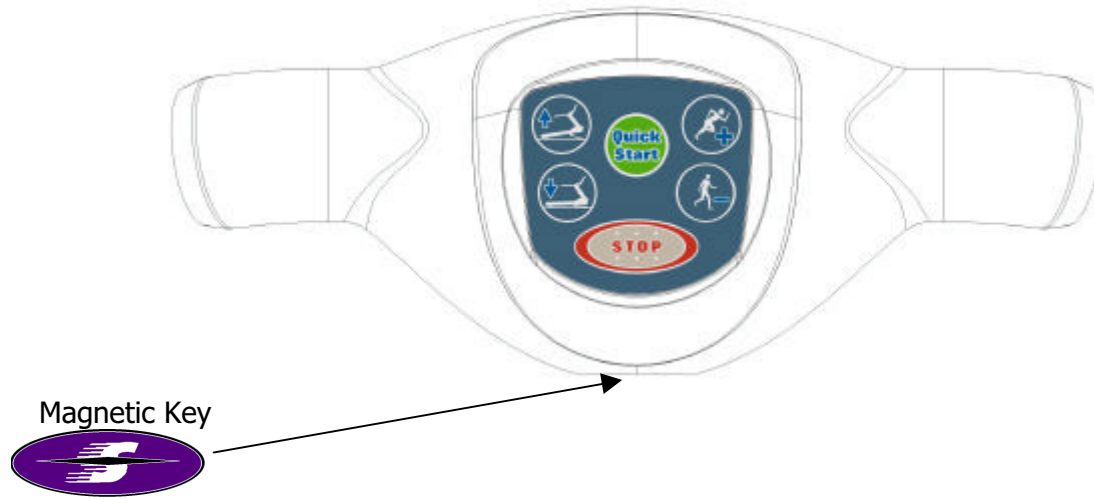

The magnet will activate the control. If you remove the key, the treadmill belt will stop and the controller will not respond to any key presses. Accumulated values will remain on the display until you turn off the power, or press [CLEAR].

The console will display a message, "REPLACE MAGNET" when you remove the magnetic key from its designated area. You must replace the key or deactivate the control to start the walk belt.

Deactivation

To deactivate the limited-access control and permit unlimited access of the treadmill:

1. Remove the magnet key and press [CLEAR], [3], [8], [ENTER].
2. Press [Speed: +] or [Speed: -] to toggle between "ON" and "OFF." With "OFF" displayed, press [ENTER] to select "OFF."
3. The display will show "CUSTOMIZE." Press [CLEAR] or [ENTER] and the display will return to the "SELECT WORKOUT" screen.
4. The limited access control remains inactive, granting unrestricted access, until you turn the magnetic key option back on, or place the magnet back in its designated area.

Magnetic Key as an Emergency Stop

The magnetic key has a string with a clip that you can attach to the user's wrist or belt during exercise. If the user moves too far from the front handrail, the cord will pull the key off and stop the walk belt.

HEART RATE MONITORING

Heart rate monitoring helps users monitor their levels of exertion by displaying the heart rate during exercise. There are two methods of monitoring heart rate on Clubtrack treadmills:

- Telemetry (e.g., Polar®) belt. A Polar-compatible heart rate chest belt transmits the heart beat signal to the receiver in the controller. The controller displays the heart rate in beats per minute and uses the heart rate value in heart rate control mode.
- Contact heart rate (handgrip). Sensors on the handgrip detect heart rate and display it on the controller.

Telemetry Heart Rate

The telemetry heart rate monitoring system consists of the receiver, located in the controller, and a transmitter belt (purchased separately) worn across your chest. The monitoring function is activated as soon as you strap on the chest belt and step within range of the receiver in the machine. Two electrodes on the underside of the chest belt sense the heart rate signal and send it to the receiver. The heart symbol on the controller pulses to indicate that the controller is receiving a valid signal. A microprocessor in the controller calculates the heart rate and displays it, in beats per minute, on the controller.

WARNING

PACEMAKER USERS SHOULD NOT USE THE TELEMETRY TRANSMITTER BEFORE CONSULTING WITH THEIR DOCTOR.

Before you put the transmitter belt on, wet the two electrode patches (the grooved rectangles on the reverse side of the belt). Secure the transmitter belt as high under the pectoral muscles (chest) as is comfortable (at the level of the xyphoid process). The transmitter belt should fit snugly and comfortably, and allow normal breathing. When the controller detects a heart rate signal, heart rate is shown in the display automatically. Your heart rate in beats per minute and a pulsing heart icon are displayed on the controller.

After the initial belt signal is detected, the controller will enter a validation phase in which four good heart beat signals lasting four seconds are required before locking on telemetry heart rate signals for the duration of the workout session. During the validation phase the controller will not recognize contact heart rate signals. If you do not see a heart rate on the controller, try one of the following:

- Move closer to the controller.
- Tighten the elastic part of the chest belt.
- Adjust the belt higher or lower on your chest.
- Remoisten the electrodes.
- Test your chest strap with a machine that you know is working, or with a heart rate watch that you know is working.
- Check the heart rate priority setting for the ClubTrack 2100.

HEART RATE MONITORING (cont.)

Maintaining the Transmitter Belt

Clean the chest belt regularly with mild soap and water, then dry thoroughly — residual sweat and moisture keeps the transmitter active and will drain the battery in the transmitter. Do not use abrasives or chemicals such as steel wool or alcohol for cleaning, as they can damage the electrodes permanently. You can order replacement belts from StairMaster or your local fitness store.

Contact Heart Rate

The StairMaster® Treadmill exercise system features a digitized contact heart rate monitoring system. Through the use of stainless steel sensors built into the handle bar and using sophisticated software, heart rate can be checked at any time during a workout. The heart rate is displayed on the controller.

The contact heart rate system's ability to detect a heart rate signal is influenced by several factors. Movement of the muscles of the upper body produces an electrical signal (muscle artifact) that will interfere with the detection of the heart rate signal by the sensors. Movement of the hands while they are in contact with the sensors also produces interference. Calluses and hand lotion act as an insulating layer to reduce the signal strength. Also, the EKG signal generated by some individuals is not strong enough to be detected by the sensors. These individuals should opt for the telemetry method of heart rate monitoring.

Contact heart rate input signals are acquired only during contact between your hands and the stainless steel sensors on the handrails. To use the contact heart rate feature, place your hands around the handles so that your hands touch both the top and the bottom of the sensors. After the initial contact heart rate signal is detected, the controller will enter a validation phase requiring a good heart beat signal within 10 to 15 seconds, or until the system acquires a valid signal. During the validation phase the controller will not recognize telemetry heart rate signals. The controller will display a heart icon. If, during exercise, the heart rate displayed is erratic, it may be helpful to remove your hands from the handles, wipe them and place them back on the handles. In all programs, the heart rate is shown automatically in the display window the first time the sensors are touched.

EXERCISE INTENSITY, FREQUENCY, & DURATION

No single fitness program is suitable for all. All fitness programs should be designed by fitness professionals who are trained to tailor the program to the individual goals and fitness levels of each client. The following information on exercise intensity, duration, and frequency is based on averages and is included here only as a guideline for use by fitness professionals. Programs should be altered for comfort and safety when necessary.

WARNING
DO NOT BEGIN AN EXERCISE PROGRAM
WITHOUT CONSULTING A PHYSICIAN.

Intensity

Exercise intensity depends upon the capacity of the individual to do the specific type of exercise. The exercise should exceed mild demand, but should not produce fatigue, breathlessness, or mental confusion. Choose a target zone according to personal fitness goals.

- A typical conditioning intensity for a healthy adult is from 50 to 80 percent of functional capacity, which is equivalent to 55 to 85 percent of maximal heart rate. For clients wanting to reduce body fat, who have been sedentary, who are in poor physical condition, or who are just starting an exercise program, an exercise intensity at 50 to 65 percent of functional capacity or 55 to 70 percent of maximal heart rate is recommended. For healthy, active clients wanting to improve their cardiovascular condition, and intensity from 65 to 80 percent of functional capacity or 70 to 85 percent maximal heart rate is recommended. Begin exercise at low intensity, especially for sedentary persons. As fitness improves, vary the exercise within the target zone. ¹

Frequency and Duration

Fitness experts recommend that exercise be done at least three times a week and should last between 15 and 60 minutes. Spread workouts throughout the week to let the body recover properly. Begin each workout slowly and let the body warm up for at least five minutes below the target zone. Gradually increase the intensity until the client is in the target zone. Maintain the target zone for 15 to 20 minutes (15 to 60 minutes as fitness increase). Gradually reduce the intensity to let the heart rate fall below the target zone with a five minute cool-down period (see graph below). ¹

EXERCISE INTENSITY, FREQUENCY, & DURATION (continued)

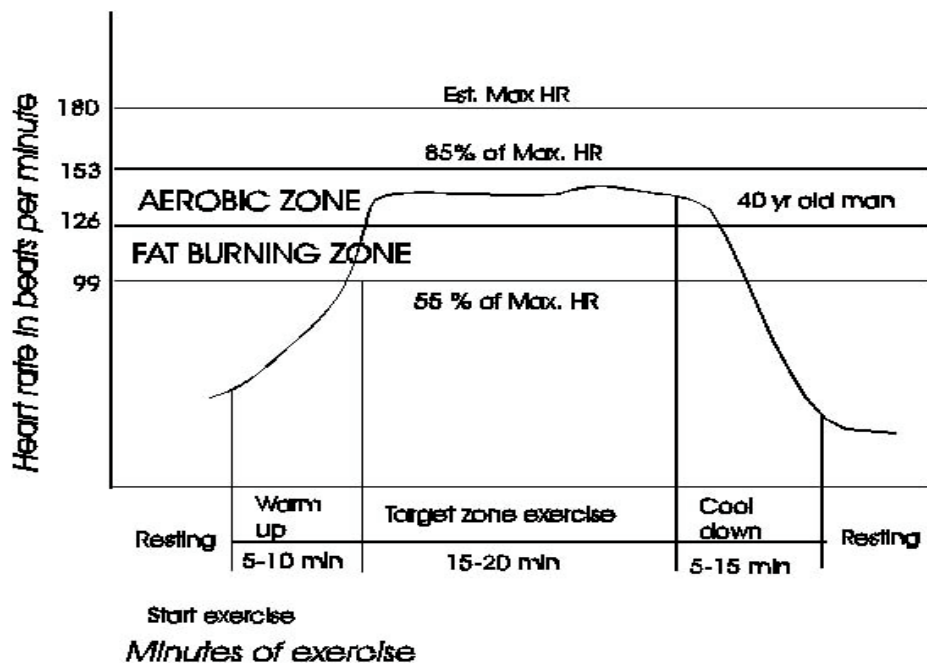
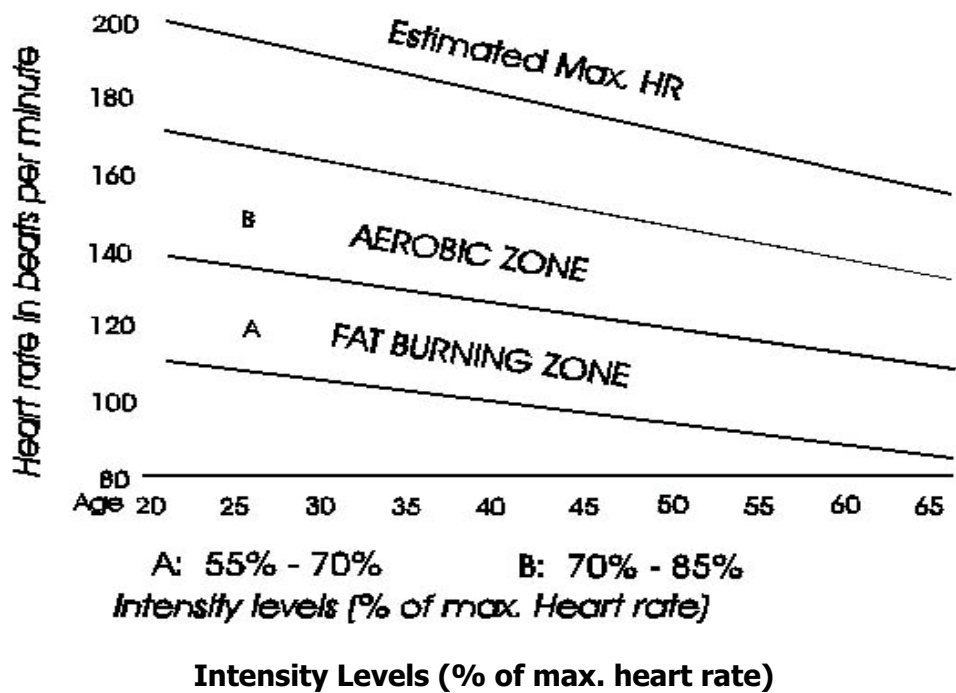

1. The American College of Sports Medicine, Guidelines for Exercise Testing and Prescription, 4th Edition, Lea & Febiger, Philadelphia, PA, 1991, pp. 93-120.

OPERATING THE CLUBTRACK 2100LE/2100LC TREADMILL

Follow the safety guidelines for using the treadmill given in the Safety Requirements section.

Turning on the Power

Turn on the circuit breaker switch on the bottom front panel of the treadmill to power on the treadmill controller. If the limited-access control is on, place the magnetic key in the designated area at the front of the handrail. Attach the cord of the key to the user's wrist or belt if desired. The screen displays "SELECT WORKOUT" after the system runs a self-test.

Understanding the Controller

The treadmill controller, which is mounted above the front handrail, is a computerized panel used to operate the treadmill. All commands are entered by pressing a soft-touch key on the panel. Visual indicators and displays show the operational status and exercise results. The controller is divided into the following sections: the display windows, the workout options, the Incline keys, the Start Belt key, the Cool Down key, the Stop key, the Display Lock / Unlock key, the Speed keys, and the numeric keypad.

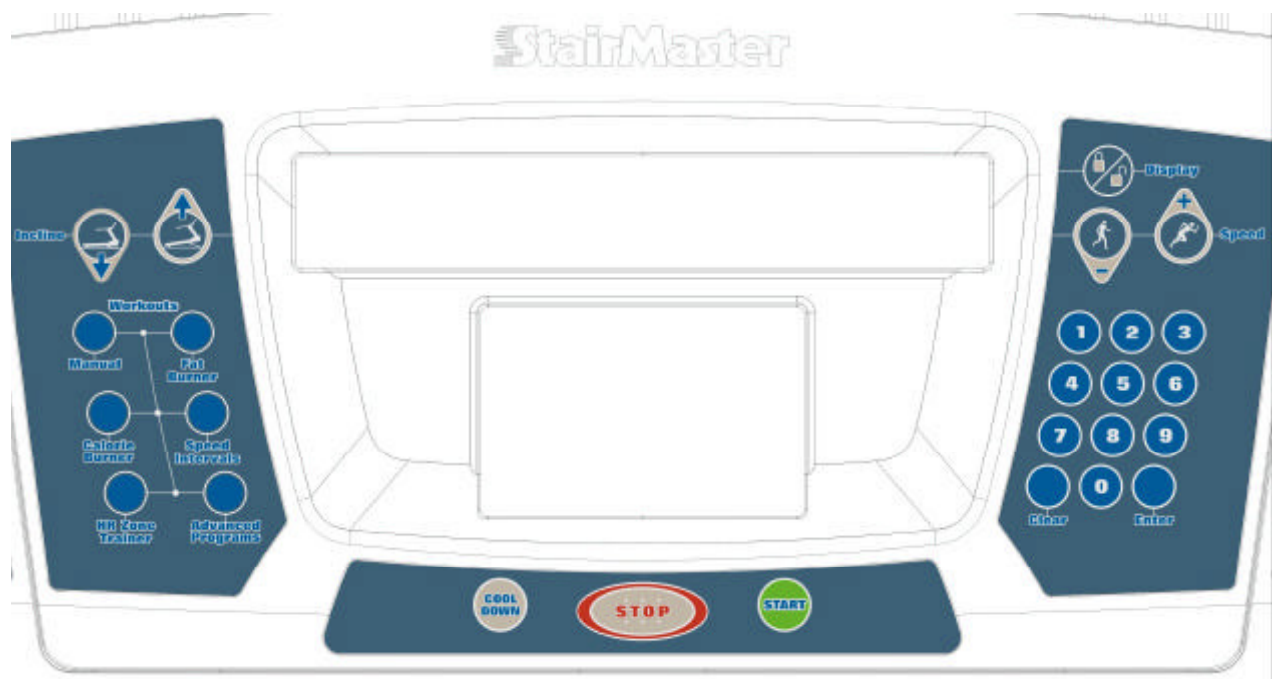

ClubTrack 2100 LE / 2100 LC Control Panel

Controller Displays and Keys

ClubTrack 2100 LC Display Windows

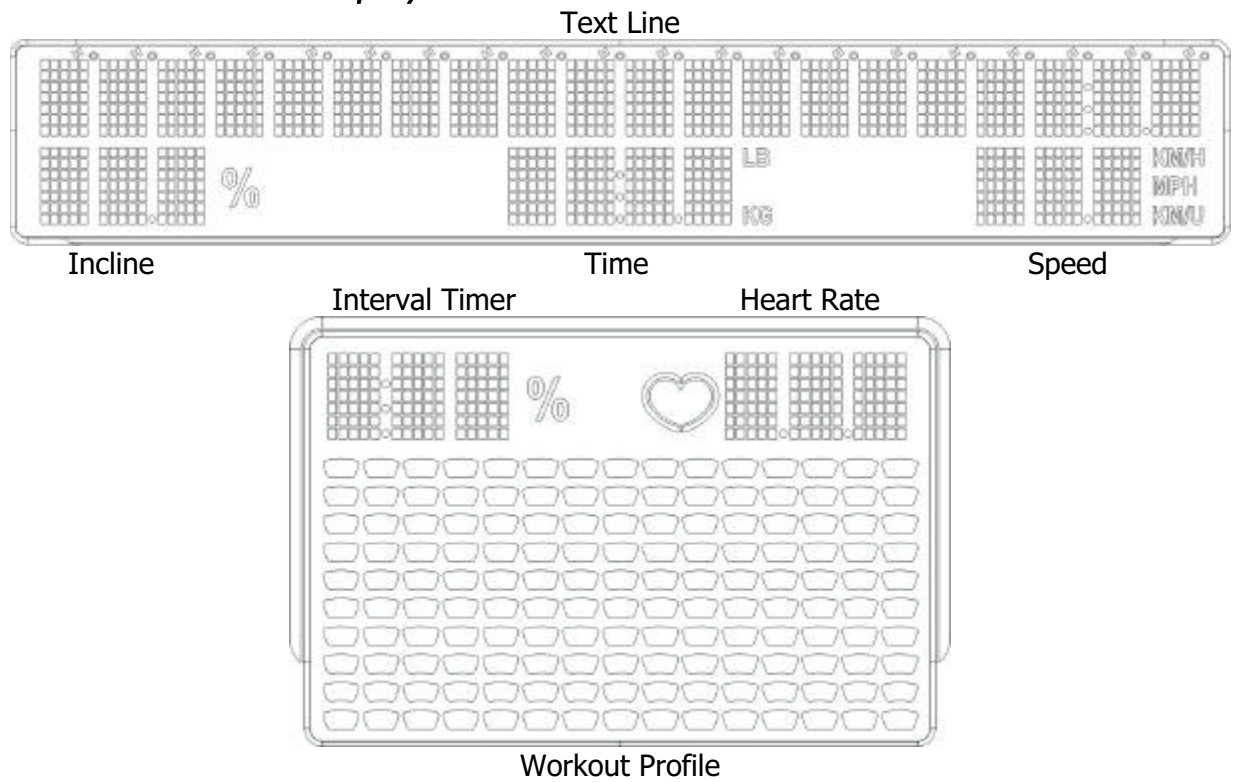

ClubTrack 2100 LE Display Windows

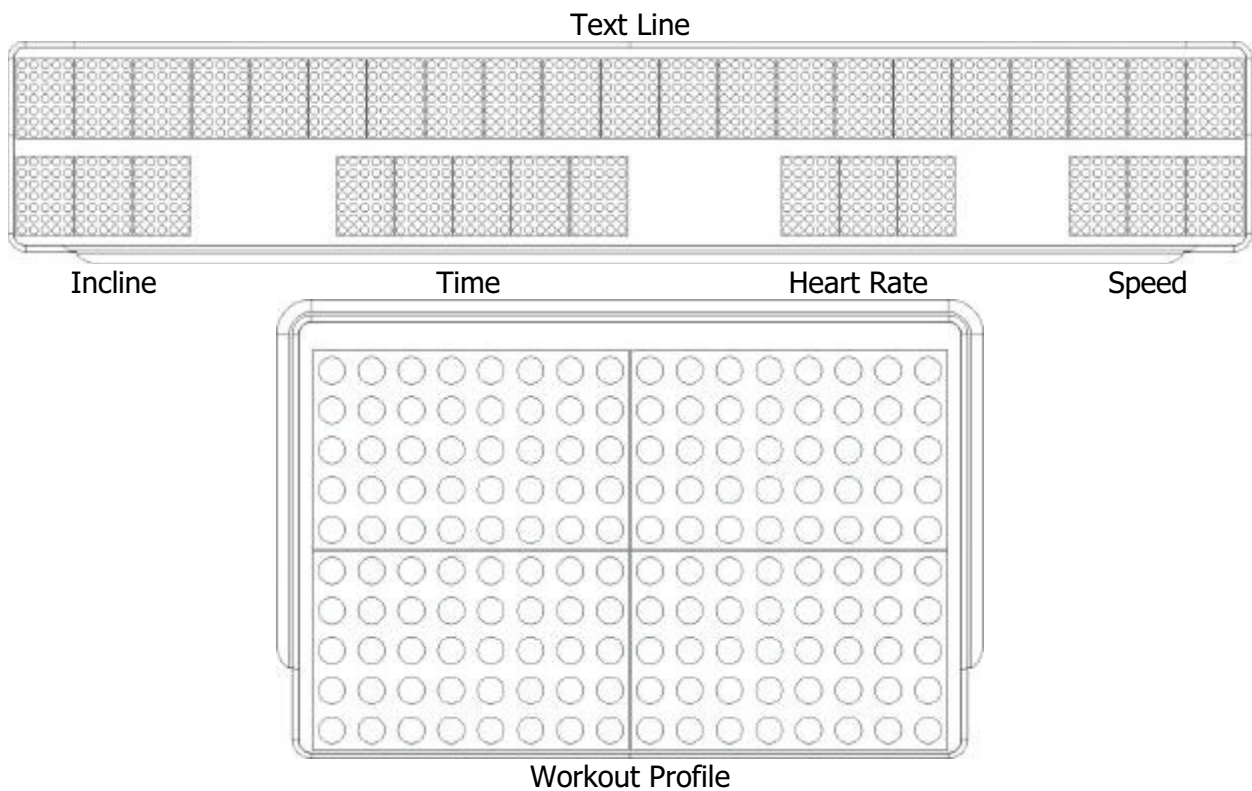

The following describes the displays, controller keys and their function on the ClubTrack 2100 LE and ClubTrack 2100 LC treadmills:

Text Line - Message prompts and statistics are displayed in the text line that is located on the top line of the upper display.

Incline – The treadmill incline is displayed in percent elevation in the left display area on the second line of the upper display. The ClubTrack 2100 LE / 2100 LC has an incline range of 0 to 15% (optional incline range is –3 to 12%).

Time - The selected workout time is displayed in the upper left section of the display window. In most of the workouts, the timer will count down, in minutes and seconds, until the workout is finished or stopped. In [MANUAL] workout or if [QUICK START] is entered, the timer will count up. The timer will also count up if [START] is pressed without selecting a workout program.

Speed - The treadmill speed is displayed in miles per hour (or kilometers per hour). The ClubTrack 2100 LE / LC has a speed range of 0.5 to 12.0 mph (0.8 to 19.2 kmh).

Heart Rate - Current heart rate is displayed next to the heart icon. On the ClubTrack 2100 LC the heart rate is displayed to the upper right in the lower display area. On the ClubTrack 2100 LE the heart rate is displayed on the second line in the upper display between the Time and Speed displays.

Interval Timer – On the ClubTrack 2100 LC only, the interval timer is displayed to the upper left in the lower display area. The interval timer counts down the remaining time within each interval. In heart rate control programs, the user's heart rate zone is displayed in terms of % of maximum predicted heart rate.

Workout Profile - A profile of the selected exercise program appears in the lower section of the display window during a workout. The taller the column, the higher the intensity (METs) for that interval. The flashing column shows your current interval. The flashing column moves from left to right across the display as you complete each interval.

Numeric keypad

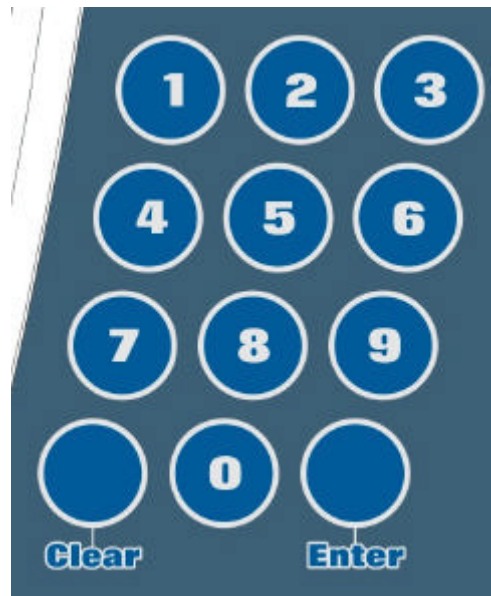

The numeric keypad is located on the right side of the controller. Before the exercise program begins, the numbers are used to enter data in response to the controller prompts. After the workout starts, the numbers are used to enter the desired speed or target heart rate.

- **Enter** - Confirms workout selections and stores the information used by the controller to calculate workout statistics.
- **Clear** - During data entry, erases information from the controller memory and backs up to the previous data entry prompt.

Incline UP [↑] / DOWN [↓] Keys



The treadmill incline may be changed at any time during a workout. Pressing the [Incline: ↑] key increases the incline and pressing the [Incline: ↓] key decreases the incline. After the first press of an Incline key, the text line will show the target incline. Further presses will increase or decrease the deck angle by one increment, or 0.5%, depending on the workout option selected.

Speed FASTER [+] / SLOWER [-] Keys



The treadmill belt speed may be changed at any time during a workout. Pressing the [Speed: -] key decreases the belt speed and pressing the [Speed: +] key increases the belt speed. The belt speed increases or decreases by 0.1 MPH (0.15 KM/H).

Start Key



The start belt key starts the walk belt with a gradual increase to the default start speed of the workout selected. You can also use this key for an immediate start to a quick-start workout session. The timer will count up from 0:00 to 99:59, then repeat from 0.

Cool Down Key



The cool down key will cause the workout program to end. The treadmill incline returns to 0% and the speed decreases to 1.0 MPH if prior speed is less than 2.0 MPH. If the prior speed was greater than 2.0 MPH the speed decreases to 2.0 MPH. You can adjust the incline and speed at any time during the cool down.

Stop Key



Press the [STOP] key any time you want to pause the workout program for up to one minute. If the [STOP] key is pressed a second time, the workout statistics will be displayed, then the controller will return to the "SELECT WORKOUT" prompt.

Display LOCK / UNLOCK - Statistics Key



During the exercise program, the Display LOCK / UNLOCK key is used to track workout statistics which are shown in the text line of the upper display window. When a workout is started, the display is in an unlocked mode and the various exercise statistics will scroll in order. Press the [DISPLAY] key once to turn off the scan feature and show the current statistic in the display window. Press the [DISPLAY] key a second time and the scan feature will turn back on to scroll through the different statistics.

When in the Display Unlock mode, the controller will cycle through the following statistics in order:

- **Distance** - Provides a cumulative total of the equivalent distance, in miles (or kilometers if your controller is set to metric units), you have traveled.
- **Calories** - Provides a current total of the number of Calories burned during a workout.
- **Calories/Hour** - Provides the rate at which calories are burned per hour at the current speed and incline.
- **Pace** - Displays the walking/running pace in minutes per mile (or minutes per kilometer).
- **Watts** - During a workout, this statistic displays the power output at the current speed and incline, displayed in watts (746 watts = 1 hp). Average power is shown during the workout summary.
- **METs** - Gives you the relative energy cost of exercise. MET stands for multiples of the resting metabolic rate. While you are sitting quietly, your body consumes oxygen at the rate of about 3.5 milliliters per kilogram of body mass per minute. When you exercise, your body needs more oxygen in order to function. For example, exercising at 10 METs requires ten times the resting rate of oxygen consumption, or about 35 milliliters per kilogram per minute. During a workout, this key shows the current MET level. During the workout summary, the average MET level is displayed.
- **Vertical feet (meters) Climbed** - Provides the number of vertical feet (meters) climbed based on the elevation settings during the workout.
- **Target Heart Rate** - Available only during the Heart Rate Control programs (HR Zone Trainer and HR Intervals). Shows the selected target heart rate.

Remote Operation Controls (ROC)



The Remote Operation Controls keypad is located on the front handrail. The treadmill can be controlled from this keypad. The ROC keypad includes a Quick Start key, Speed FASTER and SLOWER key, Incline UP and DOWN keys, and a STOP key. These keys work exactly the same as the keys on the controller. The Quick Start key works the same as the Start key on the controller. Refer to the explanation of the Start key, Speed FASTER and SLOWER keys, Incline UP and DOWN keys, and the STOP key previously defined.

Workout Program Keypad

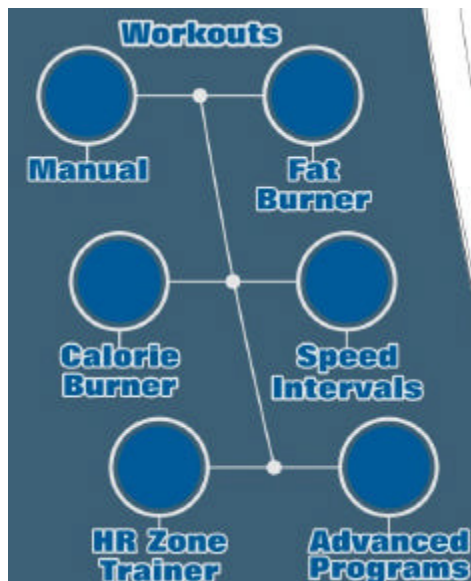

The workout program keypad is located to the left of the display. There are six workout program keys, including an Advanced Programs key with eight additional programs.

While the controller is in the "SELECT WORKOUT" mode, press one of the exercise program keys to preview the desired workout. After selecting the desired workout, simply follow the prompts to enter the required user data for that program.

When entering data, the user can select the standard default values by pressing [ENTER] at the display prompt without first typing data. This will set up the controller with the following default data:

- **Weight** - 175 lbs.
- **Speed** – 2.0 mph in Fat Burner, Calorie Burner, or HR Zone Trainer; 1.0 mph in Manual.
- **Age** (HR Control programs only) - 40 years
- **Workout Time** - The default time in the programmed workouts is 20 minutes. The Quick Start program does not have a specified default time. In this program, the controller timer will count up to the maximum time of 99 minutes, return to 0, and count up again.

Once you have selected a program, follow the controller prompts.

- **"ENTER BODY WEIGHT"** -- type in your body weight in pounds (or kilograms if your controller is set to metric units).
- **"ENTER SPEED"** – type in your desired speed. The ClubTrack 2100 has a speed range of 0.5 to 12.0 mph, in 0.1 mph increments (0.8 to 19.2 km/h).
- **"ENTER TIME 5 - 99"** -- select the workout duration in one minute increments from five to 99.

The Quick Start Program

Provides an immediate start, without having to enter any user information. This program uses the standard default settings to calculate calories burned during a workout session.

To use the Quick Start program:

1. Press the [QUICK START] key. A message similar to the following will be displayed:

				E	N	J	O	Y		W	O	R	K	O	U	T			
--	--	--	--	---	---	---	---	---	--	---	---	---	---	---	---	---	--	--	--

2. Begin the workout.
 - The speed may be changed at any time during the workout or cool down by pressing the [Speed: +] key to increase the speed, or the [Speed: -] key to decrease the speed. Or, use the numeric keypad to enter the desired speed.
 - The incline may be changed at any time during the workout or cool down by pressing the [Incline: UP] key to increase the incline, or by pressing the [Incline: DOWN] key to decrease the incline.
3. Press [COOL DOWN] to return the incline to 0%, and the speed to 1.0 mph if the workout speed was less than 2.0 mph. If the prior speed was greater than 2.0 mph, the speed decreases to 2.0 mph.
4. Press [STOP] to end the workout. The workout statistics will be displayed, and then the controller will revert back to the "SELECT WORKOUT" message.

The Manual Program

The Manual Program allows you to control the speed and incline of the treadmill during the workout, while accurately calculating exercise statistics based on your weight. The default speed is 1.0 mph unless changed during the data entry mode. The incline is 0%. The profile in the display window is divided into 15 equal intervals within the selected workout time. The profile is based on the MET level, with every 2 METs equating to one vertical bar. MET level is based on a combination of incline and speed.

To use the Manual program:

1. Press the [MANUAL] key. A screen similar to following will be displayed:

				M	A	N	U	A	L		W	O	R	K	O	U	T			
--	--	--	--	---	---	---	---	---	---	--	---	---	---	---	---	---	---	--	--	--

2. The controller will display "ENTER WEIGHT - LBS" (or "ENTER WEIGHT - KG" if in Metric mode). Enter your weight using the numeric keypad and press [ENTER]. Or, press [ENTER] to accept the default value.

- Your weight is used to calculate the number of calories burned for each minute of exercise and the total number of calories burned for the exercise session.

3. The controller will display "ENTER SPEED MPH" (or "SPEED KM/H if in Metric mode). Enter the desired speed using the numeric keypad and press [ENTER]. Or, press [ENTER] to accept the default value.

4. Next, the controller will display "WORKOUT BASED ON 1:TIME 2:DISTANCE". Press [1] if you want to enter an exercise time, or press [2] if you want to enter a workout distance (in miles or kilometers, if in metric).

If you press [1] for time, then the controller will display "ENTER TIME 5-99". Enter the desired time and press [ENTER]. Or, press [ENTER] to select the default time.

If you press [2] for distance, then the controller will display "ENTER DISTANCE". Enter the desired distance in miles (or kilometers if in Metric) and press [ENTER]. Or, press [ENTER] to select the default distance.

5. The controller will display "PRESS START". Press [START] to begin your workout.

- The speed may be changed at any time during the workout by pressing the [Speed: +] key to increase the speed, or the [Speed: -] key to decrease the speed. Or, use the numeric keypad to enter the desired speed.
- The incline may be changed at any time during the workout by pressing the [Incline: UP] key to increase the incline, or by pressing the [Incline: DOWN] key to decrease the incline.

6. Press [COOL DOWN] to return the incline to 0%, and the speed to 1.0 mph if the workout speed was less than 2.0 mph. If the prior speed was greater than 2.0 mph, the speed decreases to 2.0 mph.

- The speed may be changed at any time during the cool down by pressing the [Speed: +] key to increase the speed, or the [Speed: -] key to decrease the speed. Or, use the numeric keypad to enter the desired speed.
 - The incline may be changed at any time during cool down by pressing the [Incline: UP] key to increase the incline, or by pressing the [Incline: DOWN] key to decrease the incline.
7. Press [STOP] to end the workout. The workout statistics will be displayed, and then the controller will revert back to the "SELECT WORKOUT" message.

The Fat Burner Program

The Fat Burner program is a 60 interval workout designed with moderate changes in incline designed to stimulate fat store assimilation for users on a weight control program. The profile in the center display indicates relative intensity. Any changes to the intensity level will not change the look of the remaining profile; however, the new intensity level will continue through the rest of the workout.

- The default speed is 2.0 mph unless modified during data entry. Default time is 20 minutes and default user weight is 175 lbs unless modified during data entry. Speed is entered by the user and can be manually changed by the user with the Speed FASTER and SLOWER keys.

To use the Fat Burner program:

1. Press the [FAT BURNER] key. A message similar to following will be displayed:

						F	A	T			B	U	R	N	E	R						
--	--	--	--	--	--	---	---	---	--	--	---	---	---	---	---	---	--	--	--	--	--	--

2. The controller will display "ENTER WEIGHT - LBS" (or "ENTER WEIGHT - KG" if in Metric mode). Enter your weight using the numeric keypad and press [ENTER]. Or, press [ENTER] to accept the default value.
- Your weight is used to calculate the number of calories burned for each minute of exercise and the total number of calories burned for the exercise session.
3. The controller will display "SPEED MPH" (or "SPEED KM/H if in Metric mode). Enter the desired speed using the numeric keypad and press [ENTER]. Or, press [ENTER] to accept the default value.
4. Next, the controller will display "WORKOUT BASED ON 1:TIME 2:DISTANCE". Press [1] if you want to enter an exercise time, or press [2] if you want to enter a workout distance (in miles or kilometers, if in metric).

If you press [1] for time, then the controller will display "ENTER TIME 5-99". Enter the desired time and press [ENTER]. Or, press [ENTER] to select the default time.

If you press [2] for distance, then the controller will display "ENTER DISTANCE". Enter the desired distance in miles (or kilometers if in Metric) and press [ENTER]. Or, press [ENTER] to select the default distance.

5. The controller will display "PRESS START". Press [START] to begin your workout.
 - The speed may be changed at any time during the workout by pressing the [Speed: +] key to increase the speed, or the [Speed: -] key to decrease the speed. Or, use the numeric keypad to enter the desired speed.
 - The incline may be changed at any time during the workout by pressing the [Incline: UP] key to increase the incline, or by pressing the [Incline: DOWN] key to decrease the incline.
6. Press [COOL DOWN] to return the incline to 0%, and the speed to 1.0 mph if the workout speed was less than 2.0 mph. If the prior speed was greater than 2.0 mph, the speed decreases to 2.0 mph.
 - The speed may be changed at any time during the cool down by pressing the [Speed: +] key to increase the speed, or the [Speed: -] key to decrease the speed. Or, use the numeric keypad to enter the desired speed.
 - The incline may be changed at any time during cool down by pressing the [Incline: UP] key to increase the incline, or by pressing the [Incline: DOWN] key to decrease the incline.
7. Press [STOP] to end the workout. The workout statistics will be displayed, and then the controller will revert back to the "SELECT WORKOUT" message.

The Calorie Burner Program

The Calorie Burner program is a 60 interval workout designed for users wanting to increase their aerobic capacity. The changes of the intensity in the intervals is greater than the intervals in the Fat Burner program, and designed specifically to tax the cardiorespiratory system. The profile in the center display indicates relative intensity. Any changes to the intensity level will not change the look of the remaining profile; however, the new intensity level will continue through the rest of the workout.

- The default speed is 2.0 mph unless modified during data entry. Default time is 20 minutes and default user weight is 175 lbs unless modified during data entry. Speed is entered by the user and can be manually changed by the user with the Speed FASTER and SLOWER keys.

To use the Calorie Burner program:

1. Press the [CALORIE BURNER] key. A message similar to the following will be displayed:

			C	A	L	O	R	I	E		B	U	R	N	E	R			
--	--	--	---	---	---	---	---	---	---	--	---	---	---	---	---	---	--	--	--

2. The controller will display "ENTER WEIGHT - LBS" (or "ENTER WEIGHT - KG" if in Metric mode). Enter your weight using the numeric keypad and press [ENTER]. Or, press [ENTER] to accept the default value.
 - Your weight is used to calculate the number of calories burned for each minute of exercise and the total number of calories burned for the exercise session.
3. The controller will display "SPEED MPH" (or "SPEED KM/H if in Metric mode). Enter the desired speed using the numeric keypad and press [ENTER]. Or, press [ENTER] to accept the default value.
4. Next, the controller will display "WORKOUT BASED ON 1:TIME 2:DISTANCE". Press [1] if you want to enter an exercise time, or press [2] if you want to enter a workout distance (in miles or kilometers, if in metric).

If you press [1] for time, then the controller will display "ENTER TIME 5-99". Enter the desired time and press [ENTER]. Or, press [ENTER] to select the default time.

If you press [2] for distance, then the controller will display "ENTER DISTANCE". Enter the desired distance in miles (or kilometers if in Metric) and press [ENTER]. Or, press [ENTER] to select the default distance.
5. The controller will display "PRESS START". Press [START] to begin your workout.
 - The speed may be changed at any time during the workout by pressing the [Speed: +] key to increase the speed, or the [Speed: -] key to decrease the speed. Or, use the numeric keypad to enter the desired speed.
 - The incline may be changed at any time during the workout by pressing the [Incline: UP] key to increase the incline, or by pressing the [Incline: DOWN] key to decrease the incline.
6. Press [COOL DOWN] to return the incline to 0%, and the speed to 1.0 mph if the workout speed was less than 2.0 mph. If the prior speed was greater than 2.0 mph, the speed decreases to 2.0 mph.
 - The speed may be changed at any time during the cool down by pressing the [Speed: +] key to increase the speed, or the [Speed: -] key to decrease the speed. Or, use the numeric keypad to enter the desired speed.
 - The incline may be changed at any time during cool down by pressing the [Incline: UP] key to increase the incline, or by pressing the [Incline: DOWN] key to decrease the incline.
7. Press [STOP] to end the workout. The workout statistics will be displayed, and then the controller will revert back to the "SELECT WORKOUT" message.

The Speed Intervals Program

The Speed Intervals program is an interval workout containing 8 alternating rest intervals with 7 exercise intervals. An interval cycle consists of an exercise phase and a recovery phase. You may scale the recovery speed and the exercise speed independently - which will be saved for the remainder of the workout.

For example, if you decrease the speed during a recovery phase then subsequent recovery phases will be the same speed. However, the speed in the exercise phase remains unchanged. To change the speed of the exercise phase, you must change the speed during an exercise phase. The two phases are independent of each other in regard to speed levels. The *relative* intensity level is indicated on the profile and any changes to the intensity level will not change the look of the remaining profile.

- The exercise and recovery phase speed is set by the user during data entry. The incline is initially set at 0%, and must be changed manually by the user as desired. During the workout, speed can be changed manually by the user with the Speed FASTER and SLOWER keys.

To use the Speed Intervals program:

1. Press the [SPEED INTERVALS] key. A message similar to the following will be displayed:

		S	P	E	E	D		I	N	T	E	R	V	A	L	S			
--	--	---	---	---	---	---	--	---	---	---	---	---	---	---	---	---	--	--	--

2. The controller will display "ENTER WEIGHT - LBS" (or "ENTER WEIGHT - KG" if in Metric mode). Enter your weight using the numeric keypad and press [ENTER]. Or, press [ENTER] to accept the default value.
 - Your weight is used to calculate the number of calories burned for each minute of exercise and the total number of calories burned for the exercise session.
3. The controller will display "ENTER EXERCISE SPEED" or "ENTER WORK SPEED". Enter the desired speed for the exercise phase of the interval using the numeric keypad and press [ENTER]. Or, press [ENTER] to accept the default value.
4. The controller will display "ENTER REST SPEED". Enter the desired speed for the rest phase of the interval using the numeric keypad and press [ENTER]. Or, press [ENTER] to accept the default value.
5. The controller will display "ENTER TIME 5-99." Enter the desired time and press [ENTER]. Or, press [ENTER] to start the timer counting up from 0.
 - The exercise time entered will be divided by 15, so that each stage will be 1/15th of the total exercise time. For example, if the user enters a 30 minute exercise time, then each rest and exercise stage will be 2 minutes in length.

6. The controller will display "PRESS START". Press [START] to begin your workout.
 - The speed may be changed at any time during the workout by pressing the [Speed: +] key to increase the speed, or the [Speed: -] key to decrease the speed. Or, use the numeric keypad to enter the desired speed. Remember – any speed changes will only affect the interval stage that you are in, rest or exercise, and not both.
 - The incline may be changed at any time during the workout by pressing the [Incline: UP] key to increase the incline, or by pressing the [Incline: DOWN] key to decrease the incline. Any incline changes will only affect the incline in the rest or exercise stage that you are in, and any subsequent rest or exercise stages, not both.
7. Press [COOL DOWN] to return the incline to 0%, and the speed to 1.0 mph if the workout speed was less than 2.0 mph. If the prior speed was greater than 2.0 mph, the speed decreases to 2.0 mph.
 - The speed may be changed at any time during the cool down by pressing the [Speed: +] key to increase the speed, or the [Speed: -] key to decrease the speed. Or, use the numeric keypad to enter the desired speed.
 - The incline may be changed at any time during cool down by pressing the [Incline: UP] key to increase the incline, or by pressing the [Incline: DOWN] key to decrease the incline.
8. Press [STOP] to end the workout. The workout statistics will be displayed, and then the controller will revert back to the "SELECT WORKOUT" message.

Heart Rate (HR) Zone Trainer Program (requires chest strap)

The Heart Rate Zone Trainer program allows you to exercise at a selected target heart rate. Once a heart rate control method is selected (speed or incline), the controller adjusts the treadmill's speed or incline to maintain the target heart rate. You must use a transmitter belt (chest strap) to send a heart rate signal to the controller. This program does not work with contact heart rate.

- If the heart rate control "Incline" method is chosen, the controller will adjust the incline to maintain the selected target heart rate. If the target heart rate has not been met at the maximum incline, you can use the [Speed: +] key to increase the belt speed to reach the target heart rate.

If the actual heart rate exceeds the target heart rate, the controller will reduce the incline to slow your heart rate down. If the actual heart rate is still higher than the target heart rate once the minimum incline has been reached, the controller will then reduce the belt speed to slow your heart rate down.

- If the heart rate control "Speed" method is chosen, the controller will change the belt speed from the initial starting speed selected to maintain your target heart rate. Incline can be changed manually.

To use the Heart Rate Zone Trainer program:

1. Put the chest strap on. Remember to wet the electrodes underneath the chest strap. The controller must detect a heart rate signal to allow selection of the HR Zone Trainer program.
2. Press the [HR ZONE TRAINER] key. A message similar to following will be displayed:

		H	R		Z	O	N	E		T	R	A	I	N	E	R			
--	--	---	---	--	---	---	---	---	--	---	---	---	---	---	---	---	--	--	--

3. The controller will display "ENTER WEIGHT - LBS" (or "ENTER WEIGHT - KG" if in Metric mode). Enter your weight using the numeric keypad and press [ENTER].
Or, press [ENTER] to accept the default value.
 - Your weight is used to calculate the number of calories burned for each minute of exercise and the total number of calories burned for the exercise session.
4. The controller will display "ENTER SPEED MPH" (or "ENTER SPEED KM/H if in Metric mode). Enter the desired speed using the numeric keypad and press [ENTER].
Or, press [ENTER] to accept the default value.
5. The controller will display "ENTER AGE 10 -99." Enter your age using the numeric keypad and press [ENTER].
Or, press [ENTER] to accept the default value of 40 years old.

6. The controller will display "TARGET HR." A suggested target heart rate will be displayed, based on your age. Press [ENTER] to accept the calculated target heart rate, or enter a different target heart rate using the numeric keypad and then press [ENTER]. Or, press [ENTER] to accept the default value.
 - The target heart rate selected by the controller is based on age, and is equal to 70% of your maximum heart rate which is calculated by the following equation: $(215 - (\text{Age} * .75)) * .70$. If desired, change the target heart rate at this point by using the numeric keypad to enter the new target heart rate, and then press [ENTER].
 - Change to a new target heart rate that is between 80 and 180 beats per minute at any time during a workout by using the numeric keypad to enter the new target heart rate, and then pressing [ENTER]. A change in target heart rate does not reset any speed or incline overrides made prior to the target change.
7. The 2100 LC controller will display "HR CONTROL BASED ON / 1 - SPEED : 2 - INCLINE." The 2100 LE controller will display "HR CONTROL MODE / 1 - SPEED : 2 - INCLINE". Select the type of heart rate control - either speed [1] or incline [2] - and press [ENTER]. Or, press [ENTER] to accept the default heart rate control of speed.
8. The controller will display "ENTER TIME 5-99." Enter the desired time and press [ENTER]. Or, press [ENTER] to accept the default value.
9. The controller will display "PRESS START BELT." Press [START BELT] to begin your workout.

The following messages may be displayed during a workout:

- "**CHECK HR BELT**" - Indicates that the heart rate signal has been missing for the last 30 seconds.

To change your target heart rate during the workout:

- To change your target heart rate during the workout, use the numeric keypad to enter the desired target heart rate and press ENTER to accept. The new target heart rate will be used and either the speed or incline will change automatically to achieve the new target heart rate.
10. Press [COOL DOWN] to return the incline to 0%, and the speed to 1.0 mph if the workout speed was less than 2.0 mph. If the prior speed was greater than 2.0 mph, the speed decreases to 2.0 mph.
 - The speed may be changed at any time during the cool down by pressing the [Speed: +] key to increase the speed, or the [Speed: -] key to decrease the speed. Or, use the numeric keypad to enter the desired speed.
 - The incline may be changed at any time during cool down by pressing the [Incline: UP] key to increase the incline, or by pressing the [Incline: DOWN] key to decrease the incline.
 11. Press [STOP] to end the workout. The workout statistics will be displayed, and then the controller will revert back to the "SELECT WORKOUT" mode.

The Advanced Programs

The Advanced Programs key allows the user to choose one of eight additional programs, including two Fit Test programs, a Custom Speed Interval workout, an Interval HR Control workout, 5K Fun Run, 10K Bolder Boulder Run, Custom Calorie Burn and a 9-Hole Walk.

StairMaster Fit Test – The StairMaster Fit Test is a program that estimates maximal aerobic capacity based on heart-rate response to sub-maximal exercise.

Fire Fighter Fit Test – The Firefighter Fit Test is used by Fire Departments to determine the fitness capacity of a firefighter or potential firefighter. The test is comprised of a 3 minute warm-up followed by an exercise session up to 13 minutes in length. After each minute, the treadmill speed or incline is increased according to the predefined test protocol. The subject's heart rate is monitored throughout the test. The test is complete when the subject's heart rate reaches 85% of their age-predicted maximum heart rate. A one minute cool down follows, after which a recovery heart rate is noted.

Custom Speed Interval – Workout with user-defined rest intervals and exercise intervals with alternating speed changes. During data entry, user can define Rest interval speed and time, Exercise interval speed and time, and number of intervals. The default Rest interval speed is 2 mph and Rest interval time is 2 minutes. The default Exercise interval speed is 5 mph and Exercise interval time is 2 minutes. The default number of intervals is 5. Therefore, a default Speed Interval workout is 20 minutes in length. During the workout, user may adjust the REST interval Speed and EXERCISE interval Speed independently, which is saved for remainder of the workout.

Interval HR Control – Workout that allows user to define the rest interval heart rate, the length of time at the rest interval heart rate, the exercise interval heart rate, the length of time at the exercise interval heart rate, and the total number of intervals. After the first rest and exercise interval, the program will remember the workload (either speed or incline) that the user was exercising at the end of the interval. Then, during the next interval, the program automatically goes to that workload. The HR control algorithm makes adjustments to maintain the user within that rest or exercise heart rate zone.

5K Fun Run – A fixed distance workout of 5K in length. Program does a 3-minute warm-up at user selected speed, then starts the workout prompting the user to input run speed. Program will count up from 0:00, and prompt the user at 0.5 K intervals as to progress. Program enters a 3-minute cool-down upon completion of 5K.

10K Bolder Boulder Run – similar program to 5K Fun Run with a fixed distance workout of 10K in length. The program also has predefined incline levels to estimate the actual Boulder race. After a 3-minute warm-up, the program starts the Run by prompting the user to input run speed. Program will count up from 0:00, and prompt the user at 0.5 K intervals as to progress. Program enters a 3-minute cool-down upon completion of 10K.

Custom Calorie Burn – program allows user to enter the amount of calories they want to burn during the workout. The program also prompts the user to enter exercise speed. Once the workout starts, the calories count down from the entered amount, and the time counts up from 0:00. Program enters a 3-minute cool-down upon completion of the calories entered.

9-Hole Walk – a fixed distance workout of 3,600 yards. Program does a 3-minute warm-up at user selected speed, then starts the workout prompting the user to input walk speed. Program will count up from 0:00, and prompt the user at pre-determined intervals as to progress. Program enters a 3-minute cool-down upon completion of 3,600 yards.

To use one of the Advanced Programs:

1. Press the [ADVANCED PROGRAMS] key. The following messages will be displayed:

		A	D	V	A	N	C	E	D		P	R	O	G	R	A	M	S	
			+		O	R		-		T	O		V	I	E	W			
			E	N	T	E	R			T	O		A	C	C	E	P	T	

2. To choose an Advanced Program, use the Speed + or Speed – keys to scroll through the selections. When the desired workout is displayed, press ENTER to accept.
Or, use the numeric keypad to select the desired Advanced Program workout.
3. Follow the prompts for the selected workout to enter the appropriate user and workout data.
4. At the end of data entry, the controller will display "PRESS START". Press [START] to begin your workout.

StairMaster Fit Test

The StairMaster Fit Test is a program that estimates maximal aerobic capacity based on heart-rate response to sub-maximal exercise.

The StairMaster branching protocol is a series of 3-minute stages of continuous exercise at increasing intensity. The first stage is a warm-up at approximately 4 METs. The intensity of the remaining stages is based on the heart rate response to the warm-up. The test is designed to raise the steady state heart rate of the subject to at least 115 beats/minute. It is important to remember that two consecutive heart rate measurements must be obtained above 115 beats/minute to predict VO₂max. The test typically lasts from 6 to 15 minutes. The test will terminate if the heart rate does not continue to rise from state to stage.

In the StairMaster protocol, each work rate is performed for 3 minutes, with heart rates recorded during the final 4 seconds of the second and third minutes of each stage. If the heart rates are within 5 beats/min, then the heart rate during the last minute is plotted against the work rate, and the program advances to the next 3-minute stage. The program continues for two to four stages until two steady state heart rates above 115 beats/min are obtained in two consecutive stages. The line generated from the plotted points is then extended to the age-predicted maximal heart rate. A corresponding maximal work rate and VO₂max can then be calculated.

At the end of the 3rd minute of each stage, if the heart rates at the end of the 2nd and 3rd minute are not within 5 beats/min of each other, then that work rate is maintained for an additional minute. At the end of the 4th minute, the heart rate is compared to the heart rate at the end of the 3rd minute. If the heart rates are within 5 beats/min, then the heart rate during the 4th minute is plotted against the work rate. If the heart rate at the end of the 3rd and 4th minute are not within 5 beats/min, then the work rate is maintained for one more additional minute. If the heart rate at the end of the 4th and 5th minutes are within 5 beats/min, then the heart rate at the end of the 5th minute is plotted against the work rate. If the heart rate at the end of the 4th and 5th minutes are not within 5 beats/min, then the test failed.

Once two consecutive heart rate measurements are obtained above 115 beats/min range, then the test ends successfully and the results are displayed. Estimated maximum aerobic capacity is shown in ml/kg/min and METs. Next, the results are compared to normative values for others of the same age range and gender.

To use the Fitness Test program:

1. Put the chest strap on. Remember to wet the underneath of the chest strap, over the electrodes.
2. Press [ADVANCED PROGRAMS] workout key, followed by the Speed UP key. The controller will display "STAIRMASTER FIT TEST."
3. The controller will then display "ENTER WEIGHT - LBS" (or "ENTER WEIGHT - KG" if in Metric mode). Enter your weight using the numeric key keypad.
4. The controller will display "ENTER AGE 10 -99." Enter your age using the numeric keypad.

5. The controller will display "ENTER GENDER / 1 - MALE / 2 - FEMALE. Enter your gender code using the numeric keypad.
6. The controller will display "PRESS START". Press the [START] key to begin the test. Follow the onscreen prompts. The following messages may be displayed during a fitness test:
 - "**CHECK HR BELT**" - Indicates that the heart rate signal has been missing for the last 30 seconds.
7. The test will be terminated early, and the messages "TEST TERMINATED / TRY AGAIN LATER" will be displayed if:
 - The user stops exercising at any point during the test.
 - The [STOP] key is pressed.
 - The heart rate response to each work level is the same or less than the previous work level.
 - The heart rate never reaches 115 beats/minute.
 - The heart rate continues to rise after the fifth minute.
8. The test is complete when two consecutive steady-state heart rates are obtained above 115 beats/minute. The test can be as short as 6 minutes, or as long as 15 minutes.
 - No cool down is done at the end of the test.
9. The estimated maximal aerobic capacity is displayed in METs, and VO_{2max} . The results are compared to normative values of the same age and gender¹ (see below), and given a fitness rating of "Low", "Fair", "Average", "Good", or "High."

Fitness Rating Norms (VO_{2max})

	AGE				
	20 – 29	30 – 39	40 – 49	50 – 59	60 +
Men					
High	51.4 +	50.4 +	48.2 +	45.3 +	42.5 +
Good	51.3 – 46.8	50.3 – 44.6	48.1 – 41.8	45.2 – 38.5	42.4 – 35.3
Average	46.7 – 42.5	44.5 – 41.0	41.7 – 38.1	38.4 – 35.2	35.2 – 31.8
Fair	42.4 – 39.5	40.9 – 37.4	38.0 – 35.1	35.1 – 32.3	31.7 – 28.7
Low	39.4 or less	37.3 or less	35.0 or less	32.2 or less	28.6 or less
Women					
High	44.2 +	41.0 +	39.5 +	35.2 +	35.2 +
Good	44.1 – 38.1	40.9 – 36.7	39.4 – 33.8	35.1 – 30.9	35.1 – 29.4
Average	38.0 – 35.2	36.6 – 33.8	33.7 – 30.9	30.8 – 28.2	29.3 – 25.8
Fair	35.1 – 32.3	33.7 – 30.5	30.8 – 28.3	28.1 – 25.5	25.7 – 23.8
Low	32.2 or less	30.4 or less	28.2 or less	25.4 or less	23.7 or less

¹ The American College of Sports Medicine, Guidelines for Exercise Testing and Prescription, 6th Edition, Lippincott Williams & Wilkins, Philadelphia, PA, 2000, p. 77.

FireFighter Fitness Test

The Firefighter Fit Test has a total of 16 stages lasting one minute each. The first 3 stages are a warm-up set with a speed of 3 mph and 0% incline. The following stages increase speed or incline from the previous stage. When the test terminates, the "Cool Down" mode will be entered. The "Cool Down" mode will set the speed to 1 mph and the incline to 0%.

Speed and Incline settings for Firefighter FIT TEST Stages

The Firefighter Treadmill Protocol is as follows:

<u>Stage</u>		<u>Speed</u>	<u>Incline</u>
1	Warm-up	3 mph	0 %
2	Warm-up	3 mph	0 %
3	Warm-up	3 mph	0 %
4	Stage 1 Test	4.5 mph	0 %
5	Stage 2 Test	4.5 mph	2 %
6	Stage 3 Test	5.0 mph	2 %
7	Stage 4 Test	5.0 mph	4 %
8	Stage 5 Test	5.5 mph	4 %
9	Stage 6 Test	5.5 mph	6 %
10	Stage 7 Test	6.0 mph	6 %
11	Stage 8 Test	6.0 mph	8 %
12	Stage 9 Test	6.5 mph	8 %
13	Stage 10 Test	6.5 mph	10 %
14	Stage 11 Test	7.0 mph	10 %
15	Stage 12 Test	7.0 mph	12 %
16	Stage 13 Test	7.5 mph	12 %

To use the Firefighter Fit Test program:

1. Put the chest strap on. Remember to wet the underneath of the chest strap, over the electrodes.
2. Press [ADVANCED PROGRAMS] workout key, followed by the Speed UP key. The controller will display "FIREMAN FIT TEST."
3. The controller will then display "ENTER WEIGHT - LBS" (or "ENTER WEIGHT - KG" if in Metric mode). Enter your weight using the numeric key keypad.
4. The controller will display "ENTER AGE 10 -99." Enter your age using the numeric keypad.
5. The controller will display "ENTER GENDER / 1 - MALE / 2 - FEMALE. Enter your gender code using the numeric keypad.
6. The controller will display "PRESS START". Press the [START] key to begin the test. Follow the onscreen prompts. The first 3 stages represent a 3-minute warm-up at 3 mph and 0% incline. The exercise time does not start until the warm-up is completed. At the beginning of the test, the timer will count up from 0:00.

The following messages may be displayed during a fitness test:

- **"CHECK HR BELT"** - Indicates that the heart rate signal has been missing for the last 30 seconds.
7. The test will be terminated early, and the messages "TEST TERMINATED / TRY AGAIN LATER" will be displayed if:
- The user stops exercising at any point during the test.
 - The [STOP] key is pressed.
 - 85% of the age predicted maximum heart rate is achieved.
 - If after the 16 stages have been completed, the age predicted heart rate has not been achieved.
 - The heart rate response to each work level must be greater than the heart rate response to the last level.
8. The test is complete when the subject's HR reaches 85% of their age-predicted maximum HR according to the following formula:
- $$\text{Max Heart Rate (MaxHR)} = 215 - \{0.75 * \text{Age}\}$$
- $$\text{Target Test Heart Rate} = 0.85 * \text{Max Heart Rate}$$
9. Following the test, the program enters cool down, the treadmill speed decreases to 1 mph and incline to 0%. The subject's heart rate is measured at the end of one minute.
10. At the end of the 1 minute Cool Down, the "Test Complete" message is displayed and the test statistics are scrolled twice as follows:
- Total Exercise Time
 - Target Heart Rate
 - Target Speed
 - Target Incline
 - Target METs
 - Recovery Heart Rate

Custom Speed Interval Program

In the Custom Speed Interval workout, the user can create a custom speed interval program by entering Recovery Speed and Time, Exercise Speed and Time, and total # of Intervals.

To use the Custom Speed Intervals program:

1. Press [ADVANCED PROGRAMS] workout key, followed by the Speed UP key until the controller displays "CUSTOM INTERVALS". Press ENTER to accept.
2. The controller will display "ENTER WEIGHT - LBS" (or "ENTER WEIGHT - KG" if in Metric mode). Enter your weight using the numeric keypad and press [ENTER]. Or, press [ENTER] to accept the default value.
 - Your weight is used to calculate the number of calories burned for each minute of exercise and the total number of calories burned for the exercise session.
3. The controller will display "ENTER REST SPEED". Enter the desired speed for the rest phase of the interval using the numeric keypad and press [ENTER]. Or, press [ENTER] to accept the default value of 2 MPH.
4. Next, the controller will display "ENTER REST TIME". Enter the desired interval time for the rest stage using the numeric keypad and press [ENTER] to accept. Or, press [ENTER] to accept the default value of 2 minutes.
5. The controller will display "ENTER WORK SPEED". Enter the desired speed for the work phase of the interval using the numeric keypad and press [ENTER]. Or, press [ENTER] to accept the default value of 5 MPH.
6. The controller will display "ENTER WORK TIME". Enter the desired interval time for the exercise stage using the numeric keypad, and press [ENTER] to accept. Or, press [ENTER] to accept the default value of 2 minutes.
7. The controller will display "ENTER # OF INTERVALS". Enter the desired number of speed intervals using the numeric keypad, and press [ENTER] to accept. Or, press [ENTER] to accept the default value of 5.
 - REMEMBER – one interval is equal to one rest phase and one exercise phase.
8. The controller will display "PRESS START". Press [START] to begin your workout.
 - The speed may be changed at any time during the workout by pressing the [Speed: +] key to increase the speed, or the [Speed: -] key to decrease the speed. Or, use the numeric keypad to enter the desired speed. Remember – any speed changes will only affect the interval stage that you are in, rest or exercise, and any subsequent rest or exercise stages, not both.
 - The incline may be changed at any time during the workout by pressing the [Incline: UP] key to increase the incline, or by pressing the [Incline: DOWN] key to decrease the incline. Any incline changes will only affect the rest or exercise stage that you are in, and any subsequent rest or exercise stages, not both.

9. Press [COOL DOWN] to return the incline to 0%, and the speed to 1.0 mph if the workout speed was less than 2.0 mph. If the prior speed was greater than 2.0 mph, the speed decreases to 2.0 mph.
 - The speed may be changed at any time during the cool down by pressing the [Speed: +] key to increase the speed, or the [Speed: -] key to decrease the speed. Or, use the numeric keypad to enter the desired speed.
 - The incline may be changed at any time during cool down by pressing the [Incline: UP] key to increase the incline, or by pressing the [Incline: DOWN] key to decrease the incline.
10. Press [STOP] to end the workout. The workout statistics will be displayed, and then the controller will revert back to the "SELECT WORKOUT" mode.

HR Control Interval Program

In the HR Control Interval workout, the user can define an exercise Target HR, time at exercise Target HR, a recovery Target HR, time at recovery Target HR, and total # of HR intervals (1 HR interval = 1 exercise Target HR interval + 1 recovery Target HR interval).

To use the HR Control Interval program:

1. Press [ADVANCED PROGRAMS] workout key, followed by the Speed UP key until the controller displays "HR CONTROL INTERVALS" (2100 LC) or "HR INTERVALS" (2100 LE). Press ENTER to accept.
2. The controller will display "ENTER WEIGHT - LBS" (or "ENTER WEIGHT - KG" if in Metric mode). Enter your weight using the numeric keypad and press [ENTER]. Or, press [ENTER] to accept the default value.
 - Your weight is used to calculate the number of calories burned for each minute of exercise and the total number of calories burned for the exercise session.
3. The controller will display "ENTER AGE 10 -99." Enter your age using the numeric keypad and press [ENTER]. Or, press [ENTER] to accept the default value of 40 years old.
4. The controller will display "REST TARGET HR." A suggested rest target heart rate will be displayed, based on your age and represents 65% of your age-predicted maximum heart rate. Press [ENTER] to accept the calculated target heart rate, or enter a different target heart rate using the numeric keypad and then press [ENTER]. Or, press [ENTER] to accept the default value.
 - The target heart rate selected by the controller is based on age, and is equal to 65% of your maximum heart rate which is calculated by the following equation: $(215 - (\text{Age} \cdot .75)) \times .65$ (where Max HR = $215 - (\text{Age} \cdot .75)$). If desired, change the target heart rate at this point by using the numeric keypad to enter the new target heart rate, and then press [ENTER].
 - Change to a new target heart rate that is between 80 and 180 beats per minute at any time during a workout by using the numeric keypad to enter the new target heart rate, and then pressing [ENTER]. A change in target heart rate does not reset any speed or incline overrides made prior to the target change.
5. Next, the controller will display "ENTER REST TIME". Enter the desired interval time for the rest stage using the numeric keypad and press [ENTER] to accept. Or, press [ENTER] to accept the default value of 2 minutes.
 - NOTE: The Rest Time does not start until your heart rate is within 5 beats/minute of the Target Rest Heart Rate.
 - Valid Rest Times are between 30 seconds and 49 minutes.

6. The controller will display "WORK TARGET HR". A suggested work target heart rate will be displayed, based on your age and represents 80% of your age-predicted maximum heart rate. Press [ENTER] to accept the calculated target heart rate, or enter a different work target heart rate using the numeric keypad and then press [ENTER]. Or, press [ENTER] to accept the default value.
 - The target heart rate selected by the controller is based on age, and is equal to 80% of your maximum heart rate which is calculated by the following equation: $(215 - (\text{Age} \times .75)) \times .80$ (where Max HR = $215 - (\text{Age} \times .75)$). If desired, change the target heart rate at this point by using the numeric keypad to enter the new target heart rate, and then press [ENTER].
 - Change to a new target heart rate that is between 80 and 180 beats per minute at any time during a workout by using the numeric keypad to enter the new target heart rate, and then pressing [ENTER]. A change in target heart rate does not reset any speed or incline overrides made prior to the target change.
7. The controller will display "ENTER WORK TIME". Enter the desired interval time for the exercise stage using the numeric keypad, and press [ENTER] to accept. Or, press [ENTER] to accept the default value of 2 minutes.
 - NOTE: The Work Time does not start until your heart rate is within 5 beats/minute of the Target Work Heart Rate.
 - Valid Work Times are between 30 seconds and 49 minutes.
8. The 2100 LC controller will display "HR CONTROL BASED ON / 1 - SPEED : 2 - INCLINE." The 2100 LE controller will display "HR CONTROL MODE / 1 - SPEED : 2 - INCLINE". Select the type of heart rate control - either speed [1] or incline [2] - and press [ENTER]. Or, press [ENTER] to accept the default heart rate control of speed.
9. The controller will display "ENTER # OF INTERVALS". Enter the desired number of intervals and press [ENTER]. Or, press [ENTER] to accept the default value of 2.
10. The controller will display "PRESS START". Press [START] to begin your workout.
 - The speed may be changed at any time during the workout by pressing the [Speed: +] key to increase the speed, or the [Speed: -] key to decrease the speed. Or, use the numeric keypad to enter the desired speed. Remember – any speed changes will only affect the interval stage that you are in, rest or exercise, not both.
 - The incline may be changed at any time during the workout by pressing the [Incline: UP] key to increase the incline, or by pressing the [Incline: DOWN] key to decrease the incline. Any incline changes will only affect the incline in the rest or exercise stage that you are in, and any subsequent rest or exercise stages, not both.

- **NOTE** – After the first Rest and Work interval, the program stores the Speed and Incline workloads at the end of the Rest and Work interval portion. Then, when the workout moves to the second interval, the program will automatically change speed and incline to the saved workloads. The HR Control Algorithm will adjust speed or incline to maintain the user at the desired Rest or Work HR range after waiting for 30 seconds. At the end of the second Rest and Work interval, the program will restore the Speed and Incline workloads at the end of the Rest and Work interval portion, to be used during the next interval. This repeats until the workout time is reached and the program moves into the Cool Down stage.
11. Press [COOL DOWN] to return the incline to 0%, and the speed to 1.0 mph if the workout speed was less than 2.0 mph. If the prior speed was greater than 2.0 mph, the speed decreases to 2.0 mph.
 - The speed may be changed at any time during the cool down by pressing the [Speed: +] key to increase the speed, or the [Speed: -] key to decrease the speed. Or, use the numeric keypad to enter the desired speed.
 - The incline may be changed at any time during cool down by pressing the [Incline: UP] key to increase the incline, or by pressing the [Incline: DOWN] key to decrease the incline.
 12. Press [STOP] to end the workout. The workout statistics will be displayed, and then the controller will revert back to the "SELECT WORKOUT" mode.

5K Fun Run Program

The 5K Fun Run workout is a fixed-distance workout. The user enters weight and treadmill speed. Then, the program runs for a distance of 5K (or 3.125 miles). Time counts up from 0:00. The user can adjust speed and incline as desired throughout the program.

To use the 5K Fun Run program:

1. Press [ADVANCED PROGRAMS] workout key, followed by the Speed UP key until the controller displays "5K FUN RUN". Press ENTER to accept.
2. The controller will display "ENTER WEIGHT - LBS" (or "ENTER WEIGHT - KG" if in Metric mode). Enter your weight using the numeric keypad and press [ENTER]. Or, press [ENTER] to accept the default value.
3. The controller will display "ENTER SPEED". Enter the desired exercise speed for the workout using the numeric keypad and press [ENTER]. Or, press [ENTER] to accept the default value of 2 MPH.
4. Next, the controller will display "PRESS START". Press [START] to begin your workout. The controller will then display "3 MINUTE WARMUP".
 - During the Warm-Up, the speed goes to 2 MPH and the user can adjust speed manually using the Speed Faster and Slower keys. The stage timer counts down from 3:00. At the end of 3 minutes, the program displays "Enjoy Workout" and the 5K Fun Run begins. The speed automatically increases to the speed the user entered during data entry. The timer starts counting up from 0:00 and stops when the distance reaches 5K, and program enters Cool Down.
 - During the workout, the speed may be changed at any time by pressing the [Speed: +] key to increase the speed, or the [Speed: -] key to decrease the speed. Or, use the numeric keypad to enter the desired speed.
 - The incline may be changed at any time during the workout by pressing the [Incline: UP] key to increase the incline, or by pressing the [Incline: DOWN] key to decrease the incline.
5. Press [COOL DOWN] to return the incline to 0%, and the speed to 1.0 mph if the workout speed was less than 2.0 mph. If the prior speed was greater than 2.0 mph, the speed decreases to 2.0 mph.
 - The speed may be changed at any time during the cool down by pressing the [Speed: +] key to increase the speed, or the [Speed: -] key to decrease the speed. Or, use the numeric keypad to enter the desired speed.
 - The incline may be changed at any time during cool down by pressing the [Incline: UP] key to increase the incline, or by pressing the [Incline: DOWN] key to decrease the incline.
6. Press [STOP] to end the workout. The workout statistics will be displayed, and then the controller will revert back to the "SELECT WORKOUT" mode.

10K Bolder Boulder Run Program

The 10K Bolder Boulder Run workout is a fixed-distance workout with automatic incline changes to simulate the famous Bolder Boulder 10K. The user enters weight and treadmill speed. Then, the program runs for a distance of 10K (or 6.2 miles). Time counts up from 0:00. The user can adjust speed and incline as desired throughout the program.

To use the 10K Bolder Boulder Run program:

1. Press [ADVANCED PROGRAMS] workout key, followed by the Speed UP key until the controller displays "10K BOULDER RUN". Press ENTER to accept.
2. The controller will display "ENTER WEIGHT - LBS" (or "ENTER WEIGHT - KG" if in Metric mode). Enter your weight using the numeric keypad and press [ENTER]. Or, press [ENTER] to accept the default value.
3. The controller will display "ENTER SPEED". Enter the desired exercise speed for the workout using the numeric keypad and press [ENTER]. Or, press [ENTER] to accept the default value of 2 MPH.
4. Next, the controller will display "PRESS START". Press [START] to begin your workout. The controller will then display "3 MINUTE WARMUP".
 - During the Warm-Up, the speed goes to 2 MPH and the user can adjust speed manually using the Speed Faster and Slower keys. The stage timer in the center display counts down from 3:00. At the end of 3 minutes, the program displays "Enjoy Workout" and the 10K Boulder Run begins. The speed automatically increases to the speed the user entered during data entry. The timer starts counting up from 0:00 and stops when the distance reaches 10K, and program enters Cool Down.
 - During the workout, the speed may be changed at any time by pressing the [Speed: +] key to increase the speed, or the [Speed: -] key to decrease the speed. Or, use the numeric keypad to enter the desired speed.
 - The incline may be changed at any time during the workout by pressing the [Incline: UP] key to increase the incline, or by pressing the [Incline: DOWN] key to decrease the incline.
5. Press [COOL DOWN] to return the incline to 0%, and the speed to 1.0 mph if the workout speed was less than 2.0 mph. If the prior speed was greater than 2.0 mph, the speed decreases to 2.0 mph.
 - The speed may be changed at any time during the cool down by pressing the [Speed: +] key to increase the speed, or the [Speed: -] key to decrease the speed. Or, use the numeric keypad to enter the desired speed.
 - The incline may be changed at any time during cool down by pressing the [Incline: UP] key to increase the incline, or by pressing the [Incline: DOWN] key to decrease the incline.

6. Press [STOP] to end the workout. The workout statistics will be displayed, and then the controller will revert back to the "SELECT WORKOUT" mode.

Custom Calorie Burn Program

The Custom Calorie Burn workout allows the user to enter a calorie expenditure amount (for example: 300 calories). The user enters weight and treadmill speed. Then, the program runs for the amount of time it takes to burn the entered calorie amount. Time counts up from 0:00. The user adjusts speed and incline as desired throughout the program.

To use the Custom Calorie Burn program:

1. Press [ADVANCED PROGRAMS] workout key, followed by the Speed UP or DOWN keys until the controller displays "CUSTOM CAL BURN". Press ENTER to accept.
2. The controller will display "ENTER WEIGHT - LBS" (or "ENTER WEIGHT - KG" if in Metric mode). Enter your weight using the numeric keypad and press [ENTER]. Or, press [ENTER] to accept the default value.
3. The controller will display "ENTER SPEED". Enter the desired exercise speed for the workout using the numeric keypad and press [ENTER]. Or, press [ENTER] to accept the default value of 2 MPH.
4. The controller will display "ENTER CALORIES". Enter the desired number of calories to burn for the workout using the numeric keypad and press [ENTER]. Or, press [ENTER] to accept the default value.
5. The controller will display "PRESS START". Press [START] to begin your workout.
 - The speed may be changed at any time during the workout by pressing the [Speed: +] key to increase the speed, or the [Speed: -] key to decrease the speed. Or, use the numeric keypad to enter the desired speed.
 - The incline may be changed at any time during the workout by pressing the [Incline: UP] key to increase the incline, or by pressing the [Incline: DOWN] key to decrease the incline.
6. Press [COOL DOWN] to return the incline to 0%, and the speed to 1.0 mph if the workout speed was less than 2.0 mph. If the prior speed was greater than 2.0 mph, the speed decreases to 2.0 mph.
 - The speed may be changed at any time during the cool down by pressing the [Speed: +] key to increase the speed, or the [Speed: -] key to decrease the speed. Or, use the numeric keypad to enter the desired speed.
 - The incline may be changed at any time during cool down by pressing the [Incline: UP] key to increase the incline, or by pressing the [Incline: DOWN] key to decrease the incline.
7. Press [STOP] to end the workout. The workout statistics will be displayed, and then the controller will revert back to the "SELECT WORKOUT" mode.

9-Hole Walk Program

The 9 Hole Walk workout is a fixed-distance workout. The user enters weight and treadmill speed. Then, the program runs for a distance of 2 miles (3,520 yards). Time counts up from 0:00. The user can adjust speed and incline as desired throughout the program.

To use the 9-Hole Walk program:

1. Press [ADVANCED PROGRAMS] workout key, followed by the Speed UP key until the controller displays "9 HOLE WALK". Press ENTER to accept.
2. The controller will display "ENTER WEIGHT - LBS" (or "ENTER WEIGHT - KG" if in Metric mode). Enter your weight using the numeric keypad and press [ENTER]. Or, press [ENTER] to accept the default value.
3. The controller will display "ENTER SPEED". Enter the desired exercise speed for the workout using the numeric keypad and press [ENTER]. Or, press [ENTER] to accept the default value of 2 MPH.
4. Next, the controller will display "PRESS START". Press [START] to begin your workout. The controller will then display "3 MINUTE WARMUP".
 - During the Warm-Up, the speed goes to 2 MPH and the user can adjust speed manually using the Speed Faster and Slower keys. The stage timer counts down from 3:00. At the end of 3 minutes, the program displays "Enjoy Workout" and the 9 Hole Walk begins. The speed automatically increases to the speed the user entered during data entry. The timer starts counting up from 0:00 and stops when the distance reaches 10K, and program enters Cool Down.
 - During the workout, the speed may be changed at any time by pressing the [Speed: +] key to increase the speed, or the [Speed: -] key to decrease the speed. Or, use the numeric keypad to enter the desired speed.
 - The incline may be changed at any time during the workout by pressing the [Incline: UP] key to increase the incline, or by pressing the [Incline: DOWN] key to decrease the incline.
5. Press [COOL DOWN] to return the incline to 0%, and the speed to 1.0 mph if the workout speed was less than 2.0 mph. If the prior speed was greater than 2.0 mph, the speed decreases to 2.0 mph.
 - The speed may be changed at any time during the cool down by pressing the [Speed: +] key to increase the speed, or the [Speed: -] key to decrease the speed. Or, use the numeric keypad to enter the desired speed.
 - The incline may be changed at any time during cool down by pressing the [Incline: UP] key to increase the incline, or by pressing the [Incline: DOWN] key to decrease the incline.
6. Press [STOP] to end the workout. The workout statistics will be displayed, and then the controller will revert back to the "SELECT WORKOUT" mode.

Options During a Workout

When START belt key is pressed, the message, "Enjoy Workout", will be displayed, and your workout statistics will begin to accumulate. The exercise statistics include, in order:

- Calories
- Calories / Hour
- Distance in miles or kilometers
- Vertical Climbed in feet or meters
- Power in watts
- METs
- Target Heart Rate (in Heart Rate Control programs only)

The center display or brickyard will show the exercise profile of the workout program selected. Each column represents an equal portion of the total workout and the flashing column will advance across the brickyard as you progress through your workout.

Changing Speed, Incline or Target Heart Rate During a Workout

- During the workout, the speed may be changed at any time by pressing the [Speed: +] key to increase the speed, or the [Speed: -] key to decrease the speed. Or, use the numeric keypad to enter the desired speed.

If the user presses a numeric key to change speed, then the message line will display the speed change prompt as follows:

C	H	A	N	G	E		S	P	E	E	D		#	#	.	#
---	---	---	---	---	---	--	---	---	---	---	---	--	---	---	---	---

Once you enter your desired speed, press [ENTER] to accept the new speed. Then, the controller will gradually change the treadmill speed to the new target speed.

EXCEPTION: In Heart Rate Control programs, you can use the numeric keys to change the Target Heart Rate. If the user presses a numeric key in a Heart Rate Control program, then the message line will display the target heart rate change prompt as follows:

N	E	W		T	A	R	G	E	T		H	R		#	#	#
---	---	---	--	---	---	---	---	---	---	--	---	---	--	---	---	---

Once you enter your desired target heart rate, press [ENTER] to accept, and the controller will gradually change the treadmill speed or incline to move you to the new target heart rate.

- The incline may be changed at any time during the workout by pressing the [Incline: UP] key to increase the incline, or by pressing the [Incline: DOWN] key to decrease the incline.

Pausing Your Workout

The program automatically enters the PAUSE state from a workout when the STOP key is pressed. The workout will be suspended, and the program will display the following alternating messages every 3 seconds for up to 1 minute:

P	R	E	S	S		S	T	O	P		T	O		E	N	D
	S	T	A	R	T		T	O		R	E	S	U	M	E	

When the program enters a PAUSE state, a timer begins to count down from 1 minute to show you the time remaining in the pause condition.

To leave the PAUSE state:

- At the end of the one minute count down, the current workout ends, the accumulated exercise statistics are scrolled twice, and the program returns to the opening message.
- If the user presses STOP or CLEAR, then the program ends, the accumulated exercise statistics are scrolled twice, and the program returns to the opening message.
- If the user presses the START key, then the workout proceeds from where it was suspended.

COOL DOWN

Your workout enters COOL DOWN under the following three conditions:

- 1) The COOL DOWN key is pressed during a workout;
- 2) A workout is followed through to completion, then the program automatically enters Cool Down;
- 3) In a Manual workout, the workout time reaches the owner-defined maximum time limit, then the program automatically enters Cool Down.

From a workout, pressing the COOL DOWN key will interrupt any workout program running, the incline will automatically return to 0% and the speed will return to 2 mph if prior speed was greater than 2 mph, or the speed will return to 1 mph if prior speed was 2 mph or less. Upon pressing the COOL DOWN key, a "COOL DOWN" message will be displayed.

If a workout program is completed, then the program automatically enters Cool Down, the incline returns to 0 % and the speed returns to 2 or 1 mph as described above. At the completion of a workout, a "GOAL ATTAINED" message will be displayed.

The Cool Down time is fixed at a default value of 2 minutes. The owner can modify this cool down time between 1 and 10 minutes (see owner-defined custom console codes for details). The Cool Down time will count down in the Stage Time window.

When Cool Down time expires, **the treadmill belt will STOP automatically**, and a "WORKOUT COMPLETED" message will be displayed.

If the maximum time limit is defined by the owner and the user reaches this limit during a workout, then the program automatically enters cool down, and the "COOL DOWN" message will be displayed.

Console Key Functions in Cool Down State

- *Speed and Incline keys:* The user can use the speed and incline keys to manually adjust the speed and incline of the treadmill during cool down. The user may also use the numeric keypad to enter a target speed during cool down. The user must press ENTER for the target speed to take effect.
- *To leave the COOL DOWN state,* user presses the STOP key. The program then enters the POST WORKOUT state.

End of Your Workout

The program is at the end of the workout when Cool Down is completed, or from the PAUSE state when the STOP key is pressed. At this point, each workout statistic is scrolled twice with averages calculated and displayed for Incline, Speed, Pace, Watts, METs, and Heart Rate.

After the statistics are scrolled twice, the program returns to the opening message. If the user wants to replay the exercise statistics, press the **Display LOCK/UNLOCK** key, and each exercise statistic will be scrolled once for 3 seconds.

Auto Reset

An automatic reset feature ensures the treadmill is ready for the next user. If you do not start the walk belt within one minute after entering exercise values or after pressing Stop Belt, the controller automatically resets the elapsed time and distance to zero and displays the "SELECT WORKOUT" message.

Instruction Page

For the convenience of all treadmill users, we strongly encourage you to copy the information on this page and place a copy near the treadmill. These brief instructions will assist the user with basic operating steps.

Using the ClubTrack® 2100 Treadmill

This page is a summary only. Each first-time treadmill user must be instructed in the proper use of the treadmill, as described in the ClubTrack User's Guide.

1. Follow the Safety Guidelines listed below.
2. Step on the deck, and straddle the belt. If the limited-access control is on, place the magnetic key on the controller. If using the optional heart rate monitor or controller, strap on the chest belt and transmitter.
3. Select a Workout Program (Manual, Fat Burner, Calorie Burner, Speed Intervals, HR Zone Trainer or Advanced Programs), or just press [QUICK START] or [START] to begin exercising immediately.
4. If you have selected a Workout Program, then follow the prompts to enter the required user data.
5. Press [START].
6. Grasp the handrail and step onto the moving belt.
7. Use the [Speed: +] and [Speed: -] keys to adjust the speed. Use the [Incline; UP] and the [Incline: DOWN] keys to adjust the incline.
8. When finished exercising, press [COOL DOWN] or [STOP].

SAFETY GUIDELINES

- Secure long hair and loose clothing before use.
- Keep treadmill set to minimum speed and incline, or stopped when anyone is getting on or off.
- Keep the treadmill area clear, keep the rear clear of objects.

Heart Rate Priority on ClubTrack 2100 Treadmills

Both contact heart rate and telemetry (e.g., Polar®) heart rate signal detection is available. The default priority of heart rate input is "LOCKED INPUT." If a telemetry signal is detected first, contact heart rate signals are inhibited from being detected throughout the rest of the workout session and vice-versa.

Locked/Non-Locked Heart Rate Signal Options

When the "EITHER INPUT" option is selected the heart rate source signal is not fixed during the workout session (if the signal is lost either input will be valid). If the "LOCKED INPUTS" option is selected then the heart rate source signal is locked on the first detected signal during the workout. To set a heart rate signal input, or to turn off the heart rate option all together, perform the following steps:

1. On the controller keypad, press [CLEAR], [3], [2]. At this point the screen will display "HR INPUTS." Press [ENTER] to select this option.
2. There are five options to handle heart rate input signals. Press the [SPEED: 3] and [SPEED: -] keys to scroll through the options until you find the option that you want. Press the [ENTER] key to select that option.

The options are as follows:

" **LOCKED INPUTS** " - allows either telemetry or contact heart rate signals to be detected. Once the controller has detected a valid input signal it will lock out the opposite type of signal for the duration of the workout session. For example, if you start out using contact heart rate then you are limited to using only contact heart rate during your workout session, even if the signal is lost while performing the workout, and vice-versa.

" **EITHER INPUT** " - allows either telemetry or contact heart rate signals to be detected. Does not lock out a particular input signal for the entire workout. This option will detect either input signal during a workout session, but only one at a time, and only until the other signal terminates.

" **TELEMETRY ONLY** " - locks out contact heart rate signals and will only detect telemetry signals.

" **HAND ONLY** " - locks out telemetry signals and will only detect contact heart rate signals.

" **BOTH HR OFF** " - turns off the ability to detect any heart rate signal. Used in rare situations where there is excessive interference with the heart rate signals.

- During workouts where heart rate is necessary, such as the HR Zone Trainer, HR Interval and the Fitness Test, the controller will pick up telemetry heart rate signals so that the programs are not disabled.

Error Codes

If the controller finds a fault in the system, it displays an error code (example: "CONFIG REQD"). If an error code appears, turn the circuit breaker off, and then back on to restart the system. If the error code appears again, record the code. Then, turn off the treadmill and call a StairMaster-trained service representative (see section "Troubleshooting").

Viewing Maintenance Information

The total time and distance the treadmill has been used can be viewed under Maintenance Information. This information can help you schedule treadmill maintenance and check treadmill usage.

To view maintenance information:

1. Press [CLEAR], [4], [0], [ENTER]. The controller will display the machine run time in hours since last cleared. Press [CLEAR] to exit.
2. To view the total distance the treadmill has been used, or press [CLEAR], [4], [2], [ENTER]. Press [CLEAR] to exit.

Changing the Workout Default Values

You can customize the workout programs to accept several default values, including setting the default weight, exercise time, age, target heart rate percent, initial work speed, cool down time, minimum speed, and decline option. To change the defaults in the controller:

1. Press [CLEAR], [2], [ENTER]. The controller will display "DEFAULTS"
2. Press [Incline: UP] or [Incline: DOWN] to scan through the default choices. Select the option you want to change by pressing [ENTER]. Then, use the [Speed: +] or [Speed: -] keys to view the choices for the selected option. Press [ENTER] to accept the choice for that option.

The default options are as follows:

Default User Weight

- The factory default is 175 lbs. Use the [Speed: +] and [Speed: -] keys to change the default user weight between 50 and 400 lbs.

Default Exercise Time

- The factory default is a 20 minute workout. Use the [Speed: +] and [Speed: -] keys to change the default workout time between 5 and 99 minutes.

Default User Age

- The factory default is a 40 year old user. Use the [Speed: +] and [Speed: -] keys to change the default age between 10 and 99 years of age.

Default Target Heart Rate Percentage

- The factory default for the target heart rate percentage is 70% of age-predicted maximum heart rate. Use the [Speed: +] and [Speed: -] keys to change the default THR percentage between 50 and 85%.

Default Work Speed

- The factory default for the initial work speed is 2 mph. Use the [Speed: +] and [Speed: -] keys to change the default speed between 0.5 and 4 mph.

Default Cool Down Time

- The factory default of the cool down time is 2 minutes. Use the [Speed: +] and [Speed: -] keys to change the cool down time between 1 and 10 minutes.

Default Starting Speed

- The factory default is set to 1 mph. This is the speed the treadmill will go to when the user presses [QUICK START] or [START] without selecting a program. Use the [Speed: +] and [Speed: -] keys to change the default starting speed between 1.0 and 0.5 mph.

Decline Option

- If the treadmill is installed with the decline option, then set this option to ON. The factory default is set to OFF.

3. To exit "DEFAULTS", press the [CLEAR] key.

Customizing the Treadmill

You can customize several parameters on the ClubTrack 2100 to conform to your individual requirements, including setting time limits, speed limits, changing screen contrast (2100 LC only), changing language, and changing units. To customize the controller:

1. Press [CLEAR], [3], [ENTER]. The controller will display "CUSTOMIZE."
2. Press [Incline: UP] or [Incline: DOWN] to scan through the customize choices. Select the option you want to change by pressing [ENTER]. Then, use the [Speed: +] or [Speed: -] keys to view the choices for the selected option. Press [ENTER] to accept the choice for that option.

The customize options are as follows:

Max time limit

- For no time limit, press [0], [ENTER]. The screen will display "TIME LIMIT OFF."
- Use the numeric keypad to enter the desired time limit. Press [ENTER], [ENTER] to accept the new time limit.

Change units

- Use the [Speed: +] and [Speed: -] keys to toggle between USA units and Metric units. Press [ENTER] to select your option.

Choose the type of heart rate input.

- See the Heart Rate Priority section for details of the choices.

Adjust screen contrast (2100 LC only)

- Use the [Speed: +] and [Speed: -] keys to increase or decrease the contrast level. Press [ENTER] to select your option.

Max speed

- Use the numeric keypad to enter the treadmill speed limit. Press [ENTER], to accept the new speed.

Enable magnet key

- Use the [Speed: +] and [Speed: -] keys to toggle between "ON" and "OFF." Press [ENTER] to select your option.

Reset Defaults

- This code will reset all exercise parameters to the factory defaults. Press [ENTER], to accept the default values.

3. To exit "CUSTOMIZE", press the [CLEAR] key.

Maintenance

Visually inspect and clean the treadmill regularly. Daily visual inspection should include:

- Inspect the power cord and walking belt for wear.
- Check the position of the walking belt; be sure it is not rubbing against the frame. The belt should be evenly spaced on the deck within 0.25 inch; adjust if necessary.
- Check optional side handrails to be sure they are fastened securely.
- Remove potential hazards from the treadmill area.

Cleaning

Treadmill and Controller

- **Daily:** Keep the treadmill and controller free of dust and debris. Use a damp sponge to wipe the exteriors and walking belt; do not soak surfaces. Dry all surfaces thoroughly.

WARNING

DRY MOP THE DECK UNDER THE BELT ONLY. DO NOT ADD ANY LUBRICANTS. ADDING LUBRICANTS CAN RUIN THE PROPRIETARY FRICTION-CONTROL SURFACE.

DO NOT USE DETERGENTS OR CLEANING AGENTS ON ANY PART OF THE DECK.

DO NOT LET LIQUID ENTER THE TREADMILL OR CONTROLLER. IF IT DOES, THE EQUIPMENT MUST BE INSPECTED AND TESTED FOR SAFETY BY A STAIRMATER-APPROVED TECHNICIAN BEFORE IT CAN BE USED AGAIN.

-
- **Weekly:** Elevate the treadmill to maximum incline and vacuum the floor under it to prevent excess dust and dirt from interfering with operation.

Treadmill Interior

Depending upon the treadmill environment, dust and or lint can accumulate under the hood. Periodic internal cleaning should be done by a qualified service personnel.

WARNING

DO NOT REMOVE THE TREADMILL HOOD: DANGEROUS VOLTAGES ARE PRESENT. COMPONENTS ARE SERVICEABLE ONLY BY QUALIFIED SERVICE PERSONNEL.

Treadmill Belt Adjustments

WARNING

SECURE LONG HAIR AND LOOSE CLOTHING BEFORE WORKING NEAR THE TREADMILL WALKING SURFACE OR PULLEYS.

Belt Tension

Adjust the belt tension whenever the belt slips or moves unsteadily during operation. Start by loosening the belt with the adjustment bolts.

1. Adjust the walking belt to .4% stretch. With the walking belt loose, place two marks 30.0 inches (750 mm) apart on each side of the belt, near each edge of the belt. The belt must be loose enough for you to move it from side to side on the front or rear roller.
2. Turn the adjusting bolts clockwise by equal amounts until the marks are 30 1/8 inches (753 mm) apart ($30.0 \text{ in.} / 30 \frac{1}{8} = .4\%$ stretch). This should be about 6 full turns of each adjusting bolt from the point where the belt begins to stretch.

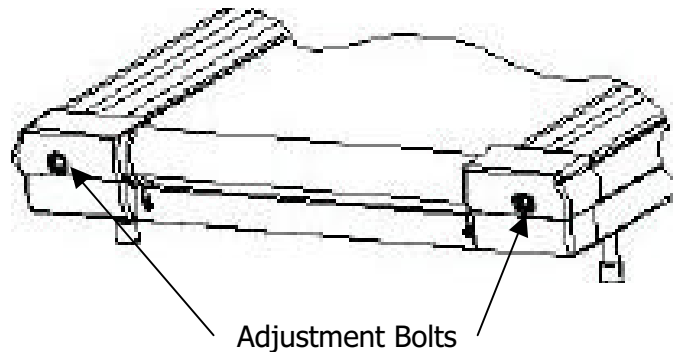

3. Run the belt at 3 MPH and make any tracking adjustments by loosening the adjusting bolt on the side where the belt is farthest from the adjustment bolt. Make small adjustments (1/4- turn) until the belt is centered on the rollers.
4. Test the belt by running on the belt at about 4 MPH. Hold the handrail lightly and resist the belt movement with your feet.

WARNING

DO NOT USE ALL YOUR WEIGHT TO RESIST THE BELT MOVEMENT. TOO MUCH RESISTANCE APPLIED TOO LONG (MORE THAN TWO SECONDS) MAY SHUT DOWN THE SYSTEM. (VARIOUS ERROR MESSAGES WILL APPEAR IF THIS OCCURS. CYCLE POWER TO RESUME NORMAL OPERATION.)

5. If you feel the belt slip on the front roller, then increase the tension of each adjusting screw by 1/2 turn and retest. If you feel the belt slip again, check the tensioner adjustment.

WARNING

DO NOT OVERTIGHTEN THE WALKING BELT. DO NOT TORQUE ADJUSTMENT SCREWS BEYOND 80 IN-LBS (9 N-M) MAXIMUM. OVERTIGHTENING THE BELT WILL DAMAGE THE BELT AND ROLLERS.

Belt Tracking

Perform this procedure whenever the belt moves to one side or the other. Stay off the belt when adjusting the tracking.

1. Start the treadmill at minimum speed and incline.
2. Increase speed to 6 mph (9.5 km/h) and make the following adjustment. The figure above shows the location of the bolts:
 - a. If the belt moves to the right, turn the right tension bolt 1/4-turn clockwise.
 - b. If the belt moves to the left, turn the left tension bolt 1/4-turn clockwise.
3. After making an initial adjustment, run the treadmill for five minutes and observe how the belt tracks. If the belt continues to move away from the center, adjust the appropriate side as in Step 2 until properly centered.

WARNING

DO NOT OVERTIGHTEN THE WALKING BELT. DO NOT TORQUE ADJUSTMENT SCREWS BEYOND 80 IN-LBS (9 N-M) MAXIMUM. OVERTIGHTENING THE BELT WILL DAMAGE THE BELT AND ROLLERS.

4. Stop the treadmill.

Belt Replacement

If the walking belt becomes worn from heavy usage, it may need to be replaced. Call StairMaster Technical Service if you have a question.

Moving and Storing the Treadmill

Moving the treadmill requires two people.

1. Set the treadmill to 3 to 5% incline.
2. To avoid electrical shock, turn off the circuit breaker on the treadmill hood, then remove the treadmill power cord from the power source before moving the treadmill.

WARNING

AS LONG AS THE TREADMILL IS PLUGGED INTO A POWERED OUTLET AND THE TREADMILL CIRCUIT BREAKER IS ON, THE UNIT IS RECEIVING POWER, EVEN IF THE CONTROLLER IS TURNED OFF.

3. Together, lift the rear of the treadmill, then roll it to the new site using the wheels on the front of the treadmill.

When storing for prolonged periods, cover the treadmill with a dust cover. Do not store in damp areas. Do not store the treadmill on its end as it could fall on someone.

Using After Storage Period

Before using the treadmill again after moving or storage, check the power cord and all attachments to be sure they are undamaged and securely connected, then test the system for proper operation.

Troubleshooting

If there is a problem with the treadmill, cycle the power by turning the circuit breaker off and then back on; this may eliminate the fault. If problems persist, refer to the Troubleshooting Guide at the end of this chapter. Problems beyond the scope of this table may require service assistance to isolate and correct. Contact StairMaster Technical Service at 800-331-3578.

- Servicing should be done only by qualified service personnel who should consult the service manual before attempting any in-depth troubleshooting.

IMPORTANT PHONE NUMBERS

If you need assistance, please have both the serial number of your machine and the date of purchase available when you contact the appropriate StairMaster office listed below.

OFFICES IN THE UNITED STATES

CORPORATE HEADQUARTERS

Nautilus Health & Fitness Group
1886 Prairie Way
Louisville, CO 80027
Phone: 800-864-1270
Fax: 800-898-9410
E-mail: customerservice@nautilushfg.com

TECHNICAL SERVICE

StairMaster Technical Service
10757 East Ute Street
Tulsa, OK 74116
Phone: 800-331-3578
Fax: 800-764-7380
E-mail: customerservice@nautilushfg.com

INTERNATIONAL OFFICES

For technical assistance and a list of distributors in your area, please call or fax one of the following numbers.

INTERNATIONAL CUSTOMER SERVICE

NORTH AMERICA OFFICE

Nautilus Health & Fitness Group
1886 Prairie Way
Louisville, CO 80027
Tel: 800-864-1270 x1603 or 1658
Fax: 303-402-4817
E-mail: international@stairmaster.com

EUROPE HEADQUARTERS

Nautilus Health & Fitness Group International S.A.
Rue Jean Prouvé 6
1762 Givisiez / Switzerland
Tel: + 41 26 460 77 77
Fax: + 41 26 460 77 70
E-mail: international@stairmaster.com

GERMANY OFFICE

Nautilus Health & Fitness Group GmbH
Tel: 02204 61027
Fax: 02204 62890
E-mail: stairmaster.de@t-online.de

U.K. OFFICE

Nautilus Health & Fitness Group UK Ltd
Tel: 01 908 267 345
Fax: 01 908 267 346
E-mail: stairmasteruk@msn.com

ITALY OFFICE

Nautilus health & Fitness Group Italy s.r.l.
Tel: 031 51 10 86
Fax: 031 34 24 97