

Printed Document Cover Sheet

Models Covered:

Description:

Language:

Part Number:

Print Specifications:

Printing Format:

Stock:

Cover:

Bindery:

Finish Size:

Page Count:

The original electronic artwork for this Operation Manual resides in the Technical Communications Department of the Marketing Communications Department. This operation manual was published on a PC using Microsoft Word 97 or Quark Xpress 4.1 and CorelDRAW Version 9.0 (All Windows Versions).

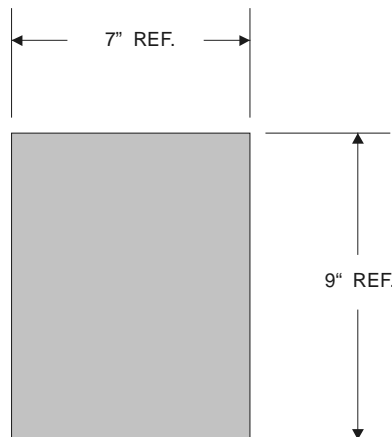

97Xi, 95Xi Total Body Trainer

OPERATION MANUAL

CORPORATE HEADQUARTERS

10601 West Belmont Avenue
Franklin Park, Illinois 60131 • U.S.A.
847.288.3300 • FAX: 847.288.3703
800.735.3867 (Toll-free within U.S.A., Canada)

INTERNATIONAL OFFICES

LIFE FITNESS ASIA PACIFIC LTD

Room 2610, Miramar Tower
132 Nathan Road
Tsimshatsui, Kowloon
HONG KONG
Telephone: (+852) 2891.6677
FAX: (+852) 2575.6001

LIFE FITNESS ATLANTIC BV

LIFE FITNESS BENELUX

Bijdorpplein 25-31
2992 LB Barendrecht
THE NETHERLANDS
Telephone: (+31) 180.646.666
FAX: (+31) 180.646.699

LIFE FITNESS BENELUX NV

Parc Industriel de Petit-Rechain
4800 Verviers
BELGIUM
Telephone: (+32) 87.300.942
FAX: (+32) 87.300.943

LIFE FITNESS DO BRAZIL

Av. Dr. Dib Sauaia Neto 1478
Alphaville, Barueri, SP
06465-140
BRAZIL
Telephone (+55) 11.4193.8282
FAX: (+55) 11.4193.8283

LIFE FITNESS AUSTRIA

Vertriebs GmbH
Hintschiggasse 1
1100 Vienna
AUSTRIA
Telephone: (+43) 1.61 57 198
FAX: (+43) 1.61 57 198.20

LIFE FITNESS IBERIA

Pol. Ind. Molí dels Frares. c/C, nº 12
08620 Sant Vicenç dels Horts (Barcelona)
Espanña
Telephone: (+34) 93.672.4660
FAX: (+34) 93.672.4670

LIFE FITNESS EUROPE GMBH

Siemensstrasse 3
85716 Unterschleissheim
GERMANY
Telephone: (+49) 89.31 77 51.0
FAX: (+49) 89.31 77 51.99

LIFE FITNESS ITALIA S.R.L.

Via San Pieretto
37010 AFFI (Verona)
ITALY
Telephone: (+39) 045.7238204
FAX: (+39) 045.7238197

LIFE FITNESS LATIN AMERICA and CARIBBEAN

10601 West Belmont Avenue
Franklin Park, Illinois 60131
U.S.A.
Telephone: (+1) 847.288.3300
FAX: (+1) 847.288.3762

LIFE FITNESS UK LTD

Queen Adelaide
Ely, Cambs CB7 4UB
UNITED KINGDOM
Telephone: (+44) 1.353.666 017
FAX: (+44) 1.353.666 018

LIFE FITNESS JAPAN

Nippon Brunswick Bldg., #8F
5-27-7 Sendagaya
Shibuya-Ku, Tokyo
Japan 151-0051
Telephone: (+81) 3.3359.4309
FAX: (+81) 3.3359.4307

Before using this product, it is essential that this ENTIRE operation manual and ALL installation instructions be read.

This will help in setting up the equipment quickly and in instructing others on how to use it correctly and safely.

Avant toute utilisation de ce produit, il est indispensable de lire ce manuel d'utilisation dans son INTÉGRALITÉ, ainsi que TOUTES les instructions d'installations.

Ce manuel explique comment installer l'équipement et comment l'utiliser correctement et sans danger.

FCC Warning - Possible Radio / Television Interference

NOTE: This equipment has been tested and found to comply with the limits for a Class A digital device, pursuant to part 15 of the FCC rules. These limits are designed to provide reasonable protection against harmful interference when the equipment is operated in a commercial environment. This equipment generates, uses and can radiate radio frequency energy, and if not installed and used in accordance with the operation manual, may cause harmful interference to radio communications. Operation of this equipment in a residential area is likely to cause harmful interference in which case the user will be required to correct the interference at his own expense.

Class S (Studio): Professional and / or commercial use.



CAUTION: Any changes or modifications to this equipment could void the product warranty.



MISE EN GARDE: Tout changement et toute modification de ce matériel peut annuler la garantie du produit.

Any service, other than cleaning or user maintenance, must be performed by an authorized service representative. There are no user serviceable parts.

TABLE OF CONTENTS

Section	Description	Page
1.	Getting Started	5
1.1	Important Safety Instructions	5
1.2	Setup	7
	Where to Place the Life Fitness® Total Body Trainer // How to Stabilize the Life Fitness Total Body Trainer // Check for Power // Fitness and Entertainment Networking	
2.	The Display Console	8
2.1	Display Console Overview	8
2.2	Display Console Descriptions	8
2.3	The Accessory Tray / Reading Rack	11
3.	Heart Rate Zone Training Exercise	12
3.1	Why Heart Rate Zone Training Exercise	12
3.2	Heart Rate Monitoring	13
	The Lifepulse™ Digital Heart Rate Monitoring System // The Polar® Telemetry Heart Rate Monitoring Chest Strap	
4.	The Workouts	15
4.1	Workout Overviews	15
4.2	Using the Workouts	16
	To Begin a Workout // Selecting and Using Quick Start // Selecting a Workout // Entering Weight // Entering Age // Entering Time // Selecting and Adjusting the Resistance Level // Selecting a Goal Type // Selecting a Workout Mode // Selecting and Adjusting Stride Length // Switching Workouts “On-the-fly” // Pausing Workouts // Ending Workouts Early // Total Body Trainer Workout Setup Steps (chart)	
4.3	Workout Descriptions	22
	Quick Start // Manual // Random // Fat Burn // Cardio // Hill // Six Pre-Set Workouts // Heart Rate Hill™ Workout // Heart Rate Interval™ Workout // Extreme Heart Rate™ Workout // Cross-Train Aerobics // Cross-Train Reverse // Fit Test	
4.4	Selecting Stride (97Xi only)	32
	Mountain Trek // Random Play // Interval Run	
5.	Optional Settings	35
5.1	Entering and Using the Optional Settings Feature	35
6.	Service And Technical Data	36
6.1	Preventive Maintenance Tips	36
6.2	Preventive Maintenance Schedule	37
6.3	Troubleshooting the Polar® Heart Rate Chest Strap	37
6.4	Troubleshooting the Lifepulse System Sensors	38
6.5	Troubleshooting the Stride Adjustment Mechanism	38
6.5	How to Obtain Product Service	39
7.	Specifications	40
7.1	Life Fitness 95Xi Fit Stride Total Body Trainer Specifications	40
7.2	Life Fitness 97Xi Select Stride Total Body Trainer Specifications	41

© 2003 Life Fitness, a division of Brunswick Corporation. All rights reserved. Life Fitness, Heart Rate Zone Training, and Lifepulse are registered trademarks of Brunswick Corporation. Fit Stride, Select Stride, Heart Rate Zone Training+, Heart Rate Hill, Heart Rate Interval, and Extreme Heart Rate are trademarks of Brunswick Corporation. Polar is a registered trademark of Polar Electro, Inc. Cardio Theater is a registered trademark of the Cardio Theater Holdings. FitLinxx is a registered trademark of the Integrated Fitness Corp. Any use of these trademarks, without the express written consent of Life Fitness or the corresponding companies is forbidden.

This Operation Manual describes the functions of the following products:

Life Fitness Select Stride™ Total Body Trainer

97Xi

Life Fitness Fit Stride™ Total Body Trainer

95Xi

See "Specifications" page in this manual for product specific features.

Statement of Purpose: The Life Fitness Total Body Trainer is an exercise machine that combines low-impact elliptical pedaling with push/pull arm motion to provide an efficient, effective total body workout.



CAUTION: Health-related injuries may result from incorrect or excessive use of exercise equipment. Life Fitness STRONGLY recommends seeing a physician for a complete medical exam before undertaking an exercise program, particularly if the user has a family history of high blood pressure or heart disease, or is over the age of 45, or smokes, has high cholesterol, is obese, or has not exercised regularly in the past year.

If, at any time while exercising, the user experiences faintness, dizziness, pain, or shortness of breath, he or she must stop immediately. In addition, if the user experiences discomfort or pain at a specific stride length, the user must stop pedaling, or adjust the stride length accordingly (if available), until the pain or discomfort disappears.



MISE EN GARDE: Des problèmes de santé peuvent être causés par une utilisation incorrecte ou excessive de l'équipement. Life Fitness conseille VIVEMENT de consulter un médecin pour subir un examen médical complet avant de commencer tout programme d'exercice, et tout particulièrement si l'utilisateur a des antécédents familiaux d'hypertension ou de troubles cardiaques, ou s'il a plus de 45 ans, s'il fume, s'il a du cholestérol, s'il est obèse ou n'a pas fait d'exercice régulièrement depuis un an.

Si, pendant l'utilisation de l'appareil, l'utilisateur ressent un malaise, des vertiges, des douleurs ou des difficultés à respirer, il doit cesser immédiatement.

1 GETTING STARTED

1.1 IMPORTANT SAFETY INSTRUCTIONS



SAFETY WARNING: The safety of the product can be maintained only if it is examined regularly for damage and wear. See Preventive Maintenance section for details.

- If this Life Fitness product does not function properly after it has been dropped, damaged, or even partially immersed in water, contact Life Fitness Customer Support Services for assistance.
- Always follow the console instructions for proper operation.
- Close supervision is necessary when used by children, invalids or disabled persons.
- Do not use this product outdoors, near swimming pools or in areas of high humidity.
- Never operate a Life Fitness product with the air openings blocked. Keep air openings free of lint, hair or any obstructing material.
- Never insert objects into any opening in this product. If an object should drop inside, carefully retrieve it. If the item cannot be reached, contact Life Fitness Customer Support Services.
- Never place liquids of any type directly on the unit, except in the accessory tray water bottle holder. Containers with lids are recommended.
- Wear shoes with rubber or high-traction soles. Do not use shoes with heels, leather soles, cleats or spikes. Make sure no stones are embedded in the soles.
- Keep all loose clothing, shoelaces and towels away from moving parts.
- Do not use this product in bare feet.
- Do not tip the unit on its side during operation.
- Keep the area around the Life Fitness product clear of any obstructions, including walls and furniture. Ensure that there is at least one foot of clearance in front of the Total Body Trainer.
- Use caution when mounting or dismounting the Total Body Trainer. Use the stationary handlebar whenever additional stability is required. While exercising, hold onto the moving arms.
- Never use the Total Body Trainer while facing backward.
- Do not stand or sit on pedal lever covers or motor housing.

SAVE THESE INSTRUCTIONS FOR FUTURE REFERENCE.

1 POINT DE DÉPART

1.1 CONSIGNES DE SÉCURITÉ IMPORTANTES



CONSIGNE DE SÉCURITÉ : pour un emploi sûr, le produit doit être inspecté régulièrement afin de s'assurer qu'il n'est pas usé ni endommagé. Consultez la section de Maintenance préventive pour obtenir de plus amples informations.

- Si l'appareil Life Fitness ne fonctionne pas correctement après avoir subi une chute, des dommages ou une immersion même partielle dans l'eau, contactez le service d'assistance clientèle de Life Fitness.
- Pour un fonctionnement correct, suivez toujours les instructions de la console.
- Une surveillance étroite est nécessaire en cas d'utilisation par des enfants, des personnes invalides ou handicapées.
- N'utilisez pas ce produit à l'extérieur, près d'une piscine ou dans endroits très humides.
- Ne faites jamais fonctionner de produit Life Fitness dont les bouches d'aération seraient bloquées. Maintenez-les exemptes de peluches, de cheveux ou de toute obstruction.
- N'insérez jamais d'objet dans les ouvertures de cet appareil. Si un objet tombe dedans, coupez l'alimentation électrique, débranchez le cordon de la prise et récupérez-le avec précaution. Si vous ne pouvez pas l'atteindre, consultez le service après-vente de Life Fitness.
- Ne placez jamais de liquides d'aucune sorte directement sur l'appareil, sauf si vous disposez d'un support ou d'un plateau pour accessoires. Il est recommandé d'utiliser des conteneurs munis d'un couvercle.
- Portez des chaussures avec semelles en caoutchouc ou antidérapantes. N'utilisez pas de chaussures à talons, de semelles en cuir ou à crampons. Assurez-vous qu'aucun caillou ne s'est incrusté dans les semelles.
- Maintenez les vêtements lâches, les lacets et les serviettes à l'écart des pièces en mouvement.
- N'utilisez pas cet appareil sans chaussures.
- Ne faites pas basculer l'appareil sur le côté tandis qu'il fonctionne.
- Maintenez la zone autour du produit Life Fitness exempte d'obstructions, y compris de murs et de meubles. Veillez à laisser au moins 30 cm d'espace autour du Total Body Trainer.
- Procédez avec précaution lors du montage ou du démontage de la machine. Utilisez la barre fixe pour renforcer votre stabilité. Pendant les exercices, saisissez les bras mobiles.
- N'utilisez jamais cet appareil en vous tournant vers l'arrière.

CONSERVEZ CES INSTRUCTIONS POUR USAGE ULTÉRIEUR.

1.2 SETUP

Read the Operation Manual before setting up the Total Body Trainer.

WHERE TO PLACE THE TOTAL BODY TRAINER

Following all safety instructions in Section 1.1, move the Total Body Trainer to the location in which it will be used. See Section 7, titled *Specifications*, for the footprint (product dimensions). Allow one foot of clearance in front of the Total Body Trainer to allow for movement of the pedal levers. It should be easy to mount the Total Body Trainer from the side.

HOW TO STABILIZE THE TOTAL BODY TRAINER

After placing the Total Body Trainer in position, check the unit's stability by attempting to rock it. Any slight rocking indicates that the unit must be leveled. Check the front stabilizing feet to determine which foot does not rest fully on the floor. Rotate the foot counter-clockwise to lower it. Recheck the stability and adjust again as needed until the Total Body Trainer is stable and no longer rocks. **Lock the adjustment into position by tightening the jam nut against the stabilizer bar with an open end 17mm wrench.**

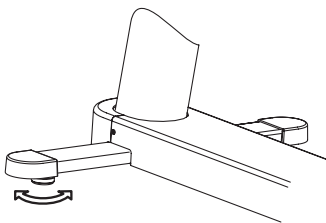

CHECK FOR POWER

The console is powered by a rechargeable 6-volt battery. Check the battery by pressing the START key. The console should light up, and the MESSAGE CENTER should display a prompt to set up a workout. If this does not occur, mount the Total Body Trainer and begin pedaling. The console should then light up, making it possible to program a workout. Pedal for 10 to 20 minutes at 1.5 mph (2.4 km/h) or faster during a workout to charge the battery. Afterwards, the pedal action during workouts keeps the battery charged. If the console still does not light, contact Life Fitness Customer Service. See section 6.5, titled *How to Obtain Product Service*, for more information.

FITNESS AND ENTERTAINMENT NETWORKING

Two interchangeable network ports allow the Total Body Trainer to be connected to a fitness entertainment system and/or a network, such as FitLinxx™ interactive fitness network.

- **Fitness network:** The network connection enables the console to upload user workout statistics to a fitness network database or to download remotely stored information, such as a pre-set workout program. See Section 4.2, titled *Using the Workouts*, for information on logging onto a network.
- **Entertainment:** The network connection enables the console to power a third-party receiver for use with a service such as the Cardio Theater® entertainment system or the BroadcastVision™ entertainment system.

These ports are located on the back of the console and are enclosed by a removable cover. Any use of the ports for other than their intended purpose could void the product warranty.

2 THE DISPLAY CONSOLE

2.1 DISPLAY CONSOLE OVERVIEW

The computerized display console allows the user to tailor a workout to personal fitness abilities and goals and to monitor progress. With this easy-to-use console, the user can track fitness improvement from one workout to the next.

95Xi DISPLAY

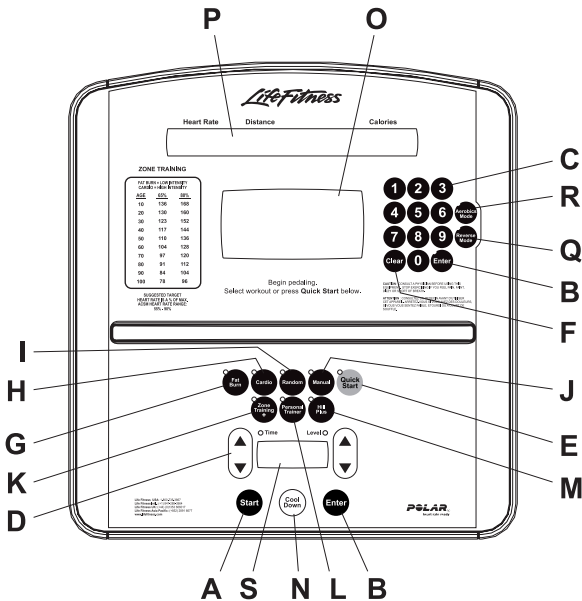

97Xi DISPLAY

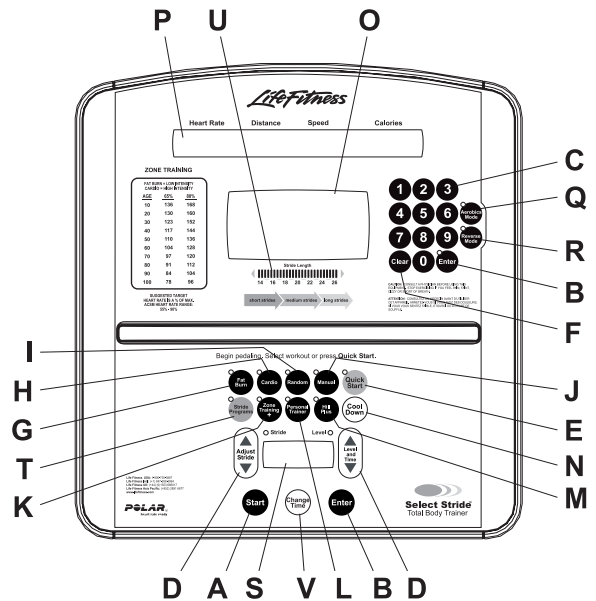

2.2 DISPLAY CONSOLE DESCRIPTIONS

This section lists and describes the functions for the keys and display windows on the console. See Section 4, titled *The Workouts*, for detailed information on using the console to set up workouts.

- A START:** Press this key to activate the console for programming a new workout. The activated console lights up and displays “SELECT WORKOUT OR PRESS QUICK START”. If no key is pressed for 15 seconds and the user stops pedaling, the console shuts down again.

NOTE: The Total Body Trainer’s AutoStart feature also activates the console when the user steps on the pedals and begins pedaling.

- B ENTER:** Press this key after entering each value, such as weight or workout time, when prompted by console display messages.
- C NUMERIC keypad:** Use these keys to enter values, such as length of workout, weight, age, target heart rate*, and intensity level. While a workout is in progress, numeric keys can be used to set new intensity levels, or to change the target heart rate* in the **FAT BURN**, **CARDIO**, **HEART RATE HILL**, **HEART RATE INTERVAL**, and **EXTREME HEART RATE INTERVAL** workouts. The **ARROW** keys have a similar function, except that they change workout parameters by single increments.

* Target Heart Rate (THR) is a percentage of the theoretical maximum. For example, a 40-year-old user’s THR for the **CARDIO** workout is 144. This workout targets 80 percent of the maximum, so the equation would be $(220-40) \cdot 80=144$.

- D** ARROW keys: A pair of UP and DOWN arrows is located on either side of the TIME/LEVEL (95xi) or STRIDE/TIME/LEVEL (97xi) window. When setting up a workout, use either set of arrows to change workout parameters displayed on the console, such as length of workout, weight, age, target heart rate*, and intensity level. During a heart rate workout, pressing the ARROWS on the right side of the display changes the target heart rate for **FAT BURN**, **CARDIO**, **HEART RATE HILL**, **HEART RATE INTERVAL**, and **EXTREME HEART RATE** workouts.

On the Fit Stride Body Trainer (95Xi) pressing the arrows on the left (TIME) side increases or decreases the workout duration. Pressing the arrows on the right (LEVEL) side increases or decreases the intensity level.

On the Select Stride Body Trainer (97Xi), pressing the arrows on the left (STRIDE) side increases or decreases stride length during any workout. Pressing the arrows on the right (TIME/LEVEL) defaults to increasing or decreasing the intensity level. To change workout duration select the CHANGE TIME button, and then use the right arrows to increase or decrease the workout duration.

NOTE: Whenever an arrow key is pressed during a workout, an increase (up arrow key) or decrease (down arrow key) is made to the corresponding parameter (stride or level). The number that appears reflects that change. For example, if the user is at level 6 and presses the right up arrow key, the number 7 will appear, reflecting that the user has chosen a new level. If the change is desired, press Enter to accept. If the change is not desired, the user has ten seconds to reset the level or stride to the desired parameter, before the unit accepts the changed value and makes the appropriate adjustments.

- E** QUICK START: Press this key to begin a manual workout immediately, without having to select a workout program. Once the workout is in progress, use the ARROW KEYS or the NUMERIC KEYPAD to change the intensity level or workout duration as desired.
- F** CLEAR: When programming a workout, press this key to clear incorrect data, such as weight or age, before pressing the ENTER key. Pressing CLEAR during a workout stops it immediately, at which point the MESSAGE CENTER displays a summary of the workout, including total time elapsed, total distance traveled, and total calories burned. Pressing CLEAR a second time causes the MESSAGE CENTER to prompt the user for a new workout setup.
- G** FAT BURN: Press this key to select the **FAT BURN** program, which is a low-intensity workout for burning fat.
- H** CARDIO: Press this key to select the **CARDIO** program, which is a higher intensity workout for more fit users, emphasizing cardiovascular benefits and maximum fat burning.
- I** RANDOM: Press this key to select the Random program, which is a workout of constantly changing intensity levels that occur in no regular pattern or progression.
- J** MANUAL: Press this key to select the Manual program, in which the intensity level remains the same unless it is manually changed.
- K** ZONE TRAINING+: Press this key to select one of the workouts that target specific ranges, or zones, for maintaining a heart rate to achieve maximum exercise results. The following options may be accessed with this key:
- **HEART RATE HILL**
 - **HEART RATE INTERVAL**
 - **EXTREME HEART RATE**
 - **TIME IN ZONE GOAL**
 - **FAT BURN** (also accessible with FAT BURN key)
 - **CARDIO** (also accessible with CARDIO key)

* Target Heart Rate (THR) is a percentage of the theoretical maximum. For example, a 40-year-old user's THR for the **CARDIO** workout is 144. This workout targets 80 percent of the maximum, so the equation would be $(220-40) \cdot 80 = 144$.

- L PERSONAL TRAINER:** Press this key for additional workout options, including customized workouts designed by a fitness club trainer or staff member. See Section 5, titled *Optional Settings* for information on designing custom workouts. The following workouts and goals may be accessed with this key:
- **CROSS-TRAIN AEROBICS**
 - **CROSS-TRAIN REVERSE**
 - **CALORIES GOAL**
 - **FIT TEST**
 - **DISTANCE GOAL**
- M HILL PLUS:** Press this key to select **HILL PLUS** workouts, in which intensity levels increase and decrease in set patterns. The following workouts may be accessed with this key:
- **HILL**
 - **AROUND THE WORLD**
 - **KILIMANJARO**
 - **INTERVAL**
 - **CASCADES**
 - **SPEED TRAINING**
 - **FOOTHILLS**
- N COOLDOWN:** Workout programs end automatically in a Cooldown mode, which lowers the intensity level. Press the COOLDOWN key at any desired point during a workout to go immediately into Cooldown mode. In this phase of a workout the body begins to remove lactic acid and other accumulated by-products of exercise, which build up in muscles during a workout and contribute to muscle soreness. The console automatically adjusts each workout's Cooldown level according to the individual user's performance.
- O WORKOUT PROFILE window:** This window displays shapes, made of columns of lights, that represent the levels of intensity in a workout-in-progress. The height of the first column on the left side of the window is proportional to the current level of intensity.
- During a **FAT BURN, CARDIO, HEART RATE HILL, HEART RATE INTERVAL, or EXTREME HEART RATE** workout, which requires the use of a Polar® heart rate chest strap or the Lifepulse system sensors, the WORKOUT PROFILE window displays a flashing heart shape to request the user's heart rate signal. If the console does not detect a signal, the MESSAGE CENTER displays the prompt "NEED HEART RATE - PLACE HANDS ON SENSORS OR USE TELEMETRY STRAP". If the console does not receive the signal within three minutes, the workout automatically is converted to a **MANUAL** program.
- P MESSAGE CENTER:** This window displays step-by-step instructions for setting up a workout. During a workout, it displays statistics about the progress of the workout:
- **Heart Rate:** the detected heart rate if the user is wearing the chest strap or grasping the Lifepulse system sensors.
 - **Distance:** the total distance traveled in miles (or kilometers if enabled).
 - **Speed:** the pedaling speed or rate in miles per hour (or kilometers per hour if enabled).
 - **Calories:** the number of calories burned since beginning the workout.
- If programmed to do so, the MESSAGE CENTER displays any or all of these three values each time the intensity level changes during the workout:
- **Calories per Hour:** the rate of calories burned per hour.
 - **Watts:** effort level in Watts. The Watt is a unit of power output or the expression of the mechanical rate of work.
 - **METs:** effort level in METs. The MET is an expression of the rate of work for the human body at rest, or a metabolic equivalent; one MET is approximately equal to the metabolism of a person at rest.

See Section 5, titled *Optional Settings* for information about enabling the MESSAGE CENTER to display these additional settings.

- Q** AEROBICS MODE: Press this key to activate a workout mode in which the MESSAGE CENTER displays prompts that vary the workload and emphasize different muscle groups during the workout. It can be used with any workout, except for **Fat Burn**, **Cardio**, **Heart Rate Hill**, **Heart Rate Interval**, **Extreme Heart Rate**, or **Stride Programs** (97Xi only).
- R** REVERSE MODE: Press this key to activate a workout mode that alternates forward motion with reverse motion. It can be used with any workout, except for **Fat Burn**, **Cardio**, **Heart Rate Hill**, **Heart Rate Interval**, **Extreme Heart Rate**, or **Stride Programs** (97Xi only).

For more information about Aerobics Mode and Reverse Mode, see the topic *Selecting a Workout Mode* in Section 4.2, titled, the Using the Workouts.

- S** LEVEL/TIME WINDOW (95xi) This window displays the programmed intensity level and the time elapsed, since the start of the program. The display toggles between level and time.
- STRIDE/TIME/LEVEL WINDOW (97xi): The display defaults to time elapsed. To adjust level use the right arrow keys. To adjust time, select CHANGE TIME, and then select the right arrow keys. To adjust stride, use the left arrow keys.
- T**. STRIDE PROGRAMS (97Xi only): Press this key to select one of the Stride Length workouts, in which stride length and resistance levels are used. The following workouts may be accessed with this key:
- **MOUNTAIN TREK**
 - **RANDOM PLAY**
 - **INTERVAL RUN**
- U**. STRIDE LENGTH INDICATOR WINDOW (97Xi only): This window displays a row of lights that shortens or lengthens as stride length changes. Blinking lights on each end indicate direction of stride change (longer or shorter). The numbers found directly under this window offer a quick visual indication of current stride length.
- V**. CHANGE TIME (97Xi only): Toggles the right arrow keys from level adjustment to workout duration adjustment. Choose CHANGE TIME, then use the right arrow keys to select a new workout duration. Select ENTER to accept the new time.

For more information about adjusting stride and using Stride Programs, see Section 4.5 *Selecting Stride*.

2.3 THE ACCESSORY TRAY / READING RACK

The accessory tray (A), which is mounted near the base of the console, provides storage for items such as water bottles, personal stereos, and cell phones. Additionally, an integrated reading rack (B) for supporting a book or magazine is located at the base of the upper panel of the console.

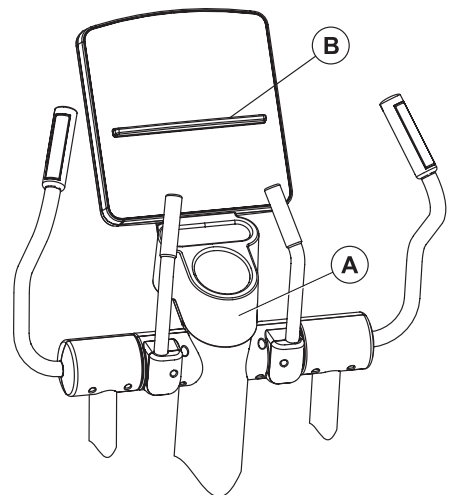

3

HEART RATE ZONE TRAINING EXERCISE

3.1 WHY HEART RATE ZONE TRAINING EXERCISE?

Research shows that maintaining a specific heart rate while exercising is the optimal way to monitor the intensity of a workout and to achieve maximum results. That is the idea behind the Life Fitness heart rate zone training approach to exercise.

Zone training identifies an exerciser's ideal heart rate range, or zone, for burning fat or increasing cardiovascular fitness. The values within the zone depend on the workout.

NOTE: Consulting a fitness trainer is recommended for defining specific fitness goals and designing a workout program.

ZONE TRAINING		
FAT BURN = LOW INTENSITY		
CARDIO = HIGH INTENSITY		
AGE	65%	80%
10	136	168
20	130	160
30	123	152
40	117	144
50	110	136
60	104	128
70	97	120
80	91	112
90	84	104
100	78	96

SUGGESTED TARGET
HEART RATE AS % OF MAX
ACSM HEART RATE RANGE:
55% - 90%

The Total Body Trainer features exclusive workouts designed to take full advantage of the benefits of heart rate zone training exercise: **FAT BURN**, **CARDIO**, **HEART RATE HILL**, **HEART RATE INTERVAL**, and **EXTREME HEART RATE**. The Time in Zone Goal option, another feature of heart rate zone training, enhances these workouts by setting a certain duration within the target zone as a workout goal. For detailed information about the workouts, as well as the Time In Zone Goal option, see Section 4, titled *The Workouts*.

During one of these workouts, grasp the Lifepulse system sensors continuously, or wear the Polar® heart rate chest strap to enable the on-board computer to monitor the heart rate during a workout. The computer automatically adjusts the resistance level to maintain the target heart rate* based on the actual heart rate. To change the target heart rate during a workout, use the LEVEL ARROW keys.

* Target Heart Rate (THR) is a percentage of the theoretical maximum. For example, a 40-year-old user's THR for the **CARDIO** workout is 144. This workout targets 80 percent of the maximum, so the equation would be $(220-40) \cdot 80 = 144$.

3.2 HEART RATE MONITORING

THE LIFEPULSE™ DIGITAL HEART RATE MONITORING SYSTEM

The patented Lifepulse system sensors are the built-in heart rate monitoring system on the Total Body Trainer. For the most accurate reading possible, during a workout:

- Grasp the sensors (A) firmly.
- Hold each sensors at the vertical midpoint.
- Keep hands steady and in place.

The console displays the heart rate within 10 to 40 seconds after the user grasps the sensors.

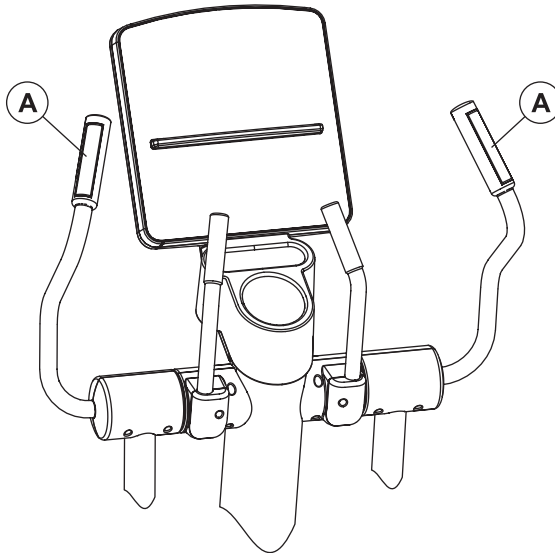

THE POLAR® TELEMETRY HEART RATE MONITORING CHEST STRAP

The Total Body Trainer is equipped with Polar® heart rate monitoring system in which electrodes, pressed against the skin, transfer heart rate signals to the console. These electrodes are attached to a chest strap that the user wears during the workout. The chest strap is optional. To order it, call Life Fitness Customer Support Services. See Section 6.6, titled *How to Obtain Product Service*.

See the diagram below for correct positioning of the strap. The electrodes (A), which are the two grooved surfaces on the underside of the strap, must remain wet to transmit accurately the electrical impulses of the heart back to the receiver. Moisten the electrodes. Then, secure the strap as high under the chest muscles as possible. The strap should be snug, but comfortable enough to allow for normal breathing.

The transmitter strap delivers an optimal heart rate reading when the electrodes are in direct contact with skin. However, it also functions properly through a thin layer of wet clothing.

If it becomes necessary to re-moisten the chest strap electrodes, grasp the center of the strap, pull it away from the chest to expose the two electrodes, and moisten them.

NOTE: If the Lifepulse system sensors are grasped while the chest strap is worn, and if the signals from the sensors are valid, the on-board computer uses the sensor signals for calculating the heart rate instead of those transmitted with the chest strap.

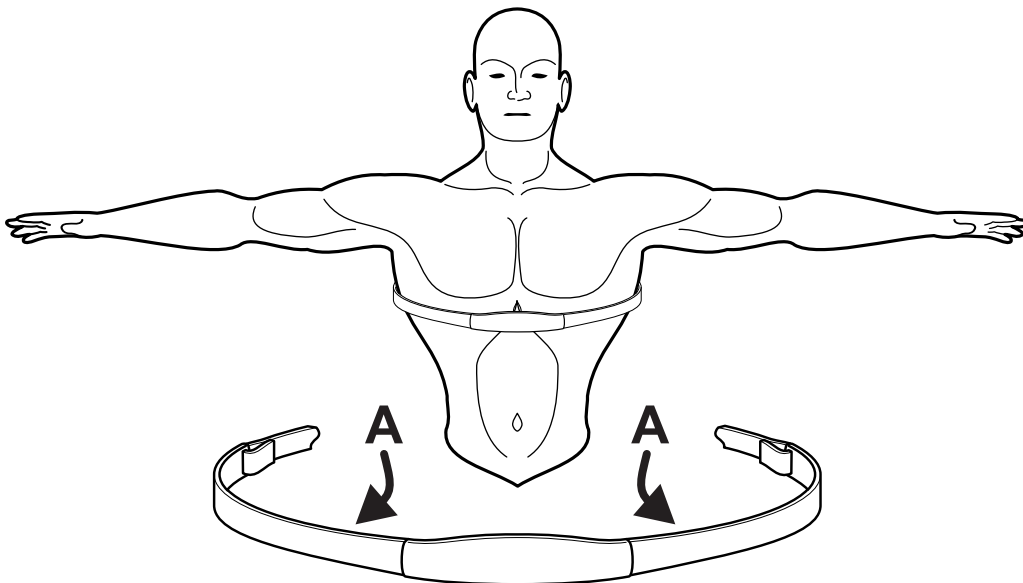

4 THE WORKOUTS

4.1 WORKOUT OVERVIEWS

This section lists the Total Body Trainer's pre-programmed workouts. For more detailed information, see Section 4.2, titled *Using the Workouts*.

QUICK START is the fastest way to begin exercising and bypasses the steps involved in selecting a specific workout program. After the QUICK START key is pressed, a constant-level workout begins. The intensity level does not change automatically.

MANUAL is a workout in which the intensity level does not change automatically. It is accessed with the MANUAL key.

RANDOM is an interval training workout of constantly changing intensity levels that occur in no regular pattern or progression. It is accessed with the RANDOM key.

FAT BURN is a low-intensity workout for burning the body's fat reserves. The user must wear a heart rate chest strap or grasp the Lifepulse system sensors continuously. The workout program automatically adjusts the intensity level, based on the actual heart rate, to maintain the rate at 65 percent of the theoretical maximum[†]. It is accessed with the FAT BURN key.

CARDIO is a higher intensity workout for more fit users, emphasizing cardiovascular benefits and maximum fat burning. The user must wear a heart rate chest strap or grasp the Lifepulse system sensors continuously. The workout program automatically adjusts the intensity level, based on the actual heart rate, to maintain the rate at 80 percent of the theoretical maximum. It is accessed with the CARDIO key.

The following workouts are accessed by pressing the ZONE TRAINING+ key:

HEART RATE HILL takes the user through three different hills based on the target heart rate*. The user must grasp the Lifepulse system sensors continuously or wear a heart rate chest strap.

HEART RATE INTERVAL alternates between a hill and a valley based on the target heart rate. The user must grasp the Lifepulse system sensors continuously or wear a heart rate chest strap.

EXTREME HEART RATE alternates between two target heart rate goals as quickly as possible. The effect is similar to that of running sprints. The user must grasp the Lifepulse system sensors continuously or wear a heart rate chest strap.

The following workouts are accessed by pressing the HILL PLUS key:

HILL is an interval-training workout combining "hills" and "valleys" of different intensity levels, which is proven to provide effective, time-efficient cardiovascular results.

AROUND THE WORLD is an interval-training workout in which the hills resemble scenes of various geographical areas.

[†] Defined by the American College of Sports Medicine's "Guidelines for Exercise Testing and Prescription" as equal to 220 minus an individual's age.

* Target Heart Rate (THR) is a percentage of the theoretical maximum. For example, a 40-year-old user's THR for the **HEART RATE HILL** workout is 144. This workout targets 80 percent of the maximum, so the equation would be $(220-40) \times .80 = 144$.

CASCADES is a two-peak workout in which intensity levels gradually increase and decrease.

FOOTHILLS is a rolling hill workout with low intensity levels.

INTERVAL is a Hill workout in which intensity levels rise and fall. The higher levels gradually incline toward a peak and then gradually decline.

KILIMANJARO is a Hill workout in which the intensity levels gradually incline toward one ultimate peak and then gradually decline.

SPEED TRAINING is a Hill workout in which the intensity level alternates between high and low levels very quickly to simulate a typical speed training workout.

The following workouts are accessed by pressing the PERSONAL TRAINER key:

CROSS-TRAIN AEROBICS simulates the experience of working with a personal trainer. The MESSAGE CENTER displays prompts at different times to emphasize pushing, pulling, total body, lower body, speed changes, and forward/reverse motion. This versatile workout promotes maximum cross-training benefits.

CROSS-TRAIN REVERSE continuously alternates periods of forward motion with periods of backward motion to cross-train different muscle groups.

FIT TEST measures cardiovascular fitness compared to other people of the same age and gender.

The following programs are accessed by pressing the STRIDE PROGRAMS key (97Xi only):

MOUNTAIN TREK is a program consisting of two hills, simulating the hiking of a mountain, and features alternating periods of short strides with high resistance and long strides with low resistance.

RANDOM PLAY is an interval training program, in which strides, hill profile, and resistance levels change in no regular pattern or progression.

INTERVAL RUN is a program that simulates interval training for runners through changes in stride length and message center prompts to change pedaling speed.

4.2 USING THE WORKOUTS

This section provides detailed information on setting up and using workouts. For quick-reference setup steps, see the chart at the end of the section.

TO BEGIN A WORKOUT

To mount the Total Body Trainer, grasp the handles and carefully step on the pedals. To dismount, step off the pedals while still holding the handles. Then let go of the handles.

Without networking, press START or begin pedaling to activate the console. The MESSAGE CENTER displays, "SELECT WORKOUT OR PRESS ENTER TO BEGIN." If it displays a different message, press the CLEAR key twice in rapid succession.

With optional networking enabled, press START or begin pedaling to activate the console. The MESSAGE CENTER displays, "SELECT WORKOUT OR ENTER ID USING ENTER KEY". Either select a workout as described below, or log on to the networked exercise database, and then select a workout. To log onto the network, key in the user ID number with the numeric keypad.

SELECTING AND USING QUICK START

QUICK START is the fastest way to begin exercising and bypasses the steps of selecting a specific workout program. At the MESSAGE CENTER prompt to select a workout, press the QUICK START key. The workout begins at an intensity level that remains the same unless manually changed. After 12 seconds, the MESSAGE CENTER displays a prompt to enter weight, which the computer requires to calculate total calories burned.

SELECTING A WORKOUT

For **MANUAL, FAT BURN, CARDIO,** and **RANDOM:** When prompted to select a workout, press the key labeled with the name of the desired workout.

For **HEART RATE HILL, HEART RATE INTERVAL,** and **EXTREME HEART RATE:** When prompted by the MESSAGE CENTER to select a workout, press the ZONE TRAINING+ key. The MESSAGE CENTER then displays the name of one of the zone training workouts. Press ENTER to select the displayed workout or continue to press the ZONE TRAINING+ key to display each of the other options. Press ENTER to select the desired workout.

For **HILL, AROUND THE WORLD, FOOTHILLS, INTERVAL, KILIMANJARO, CASCADES,** and **SPEED TRAINING:** When prompted by the MESSAGE CENTER to select a workout, press the HILL PLUS key. The MESSAGE CENTER then displays the name of the one of these workouts. Press ENTER to select the displayed workout or continue to press the HILL PLUS key to display each of the other options. Press ENTER to select the desired program.

For **CROSS-TRAIN REVERSE, CROSS-TRAIN AEROBICS,** and **FIT TEST:** When prompted by the MESSAGE CENTER to select a workout, press the PERSONAL TRAINER key. The MESSAGE CENTER displays the name a workout. Press ENTER to select the displayed workout or continue to press the PERSONAL TRAINER key to display each of the other options. Press ENTER to select the desired workout.

For **MOUNTAIN TREK, RANDOM PLAY,** and **INTERVAL RUN (97Xi only):** When prompted by the MESSAGE CENTER to select a workout, press the STRIDE PROGRAMS key. The MESSAGE CENTER then displays the name of one of these workouts. Press ENTER to select the displayed workout or continue to press the STRIDE PROGRAMS key to display each of the other options. Press ENTER to select the desired program. For more information, see section 4.5, titled *Selecting Stride*.

ENTERING WEIGHT

When prompted by the MESSAGE CENTER to enter weight, use the ARROW KEYS to increase or decrease the displayed weight to the correct value (or key in the correct value with the NUMERIC KEYPAD) and press ENTER. The default weight is 150 pounds or 68 kilograms. The on-board computer calculates the number and rate of calories burned using the entered weight as well as the pedaling speed.

ENTERING AGE

When prompted by the MESSAGE CENTER to enter age, use the ARROW KEYS to increase or decrease the displayed age to the correct value (or key in the correct value with the NUMERIC KEYPAD) and press ENTER.

Total Body Trainer workout programs that set a target heart rate* zone first calculate the user's theoretical maximum heart rate[†] by subtracting the user's age from the number 220. The programs then calculate the target zone as a percentage of the theoretical maximum.

ENTERING TIME

When prompted by the MESSAGE CENTER to enter a time, use the ARROW KEYS to increase or decrease the displayed time to the desired value (or key in the desired value with the NUMERIC KEYPAD) and press ENTER.

SELECTING AND ADJUSTING THE RESISTANCE LEVEL

When prompted by the MESSAGE CENTER, use the ARROW KEYS to increase or decrease the displayed intensity level or target heart rate* to the desired value (or key in the desired value with the NUMERIC keypad) and press ENTER. Adjust the level as needed or desired during the workout.

- Resistance level: The Total Body Trainer provides a selection of 25 resistance levels. The resistance is independent of speed. The resistance level appears in the WORKOUT PROFILE window as rows of lights arranged in columns. Selecting a low intensity level at first is recommended. As physical conditioning improves, the levels can increase.
- Target heart rate: Programs that calculate a target heart rate base this number on the age of the user and the type of workout. The user accepts or adjusts the rate when setting up the workout. During the workout itself, the program reads the heart rate, which is transmitted via the heart rate chest strap or the Lifepulse system sensors; it uses this data to adjust the resistance. Manually raising the rate increases the intensity of the cardiovascular exercise.

SELECTING A GOAL TYPE

Workouts can be programmed to target certain type of goals:

- Calories
- Distance
- Time in zone

The **Calories Goal** feature is designed to promote weight loss and weight control. The user sets a calorie goal during the workout setup. Once the goal is met, the workout automatically goes into a Cooldown Phase and ends afterward. To use this feature:

1. Press the PERSONAL TRAINER key when prompted to select a workout.
2. Continue to press the PERSONAL TRAINER key until the MESSAGE CENTER displays "CALORIES GOAL". Then press ENTER.
3. Enter the desired calorie goal value.

[†] Defined by the American College of Sports Medicine's "Guidelines for Exercise Testing and Prescription" as equal to 220 minus an individual's age.

* Target Heart Rate (THR) is a percentage of the theoretical maximum. For example, a 40-year-old user's THR for the **HEART RATE HILL** workout is 144. This workout targets 80 percent of the maximum, so the equation would be $(220-40) \cdot .80=144$.

4. Select a workout.
5. Run through the set-up steps for the selected workout.
6. Begin the workout.

The **Distance Goal** feature is designed to build endurance. The user sets a distance goal during the workout setup. Once the goal is met, the workout automatically goes into a Cooldown Phase and ends afterward. To use this feature:

1. Press the the PERSONAL TRAINER key when prompted to select a workout.
2. Continue to press the PERSONAL TRAINER key until the MESSAGE CENTER displays "DISTANCE GOAL".
3. Press ENTER.
4. Enter the desired distance goal value.
5. Select a workout.
6. Run through the set-up steps for the selected workout.
7. Begin the workout.

The **Time in Zone Goal** program enhances **FAT BURN**, **CARDIO**, **HEART RATE HILL**, **HEART RATE INTERVAL**, and **EXTREME HEART RATE** workouts by setting a certain duration within the target zone* as a workout goal. The program automatically alters the resistance to maintain a pace that will meet that objective within that duration. Once the objective is met, the workout automatically goes into a Cooldown Phase. To use the Time In Zone Goal feature:

1. Press the ZONE TRAINING+ key when prompted to select a workout
2. Continue to press the ZONE TRAINING+ key until the MESSAGE CENTER displays "TIME IN ZONE GOAL". Then press ENTER.
3. Enter weight.
4. Select the duration for staying within the zone.
5. Select a **FAT BURN**, **CARDIO**, **HEART RATE HILL**, **HEART RATE INTERVAL**, or **EXTREME HEART RATE** workout.
6. Enter age.
7. Accept or change the target heart rate displayed by the MESSAGE CENTER.
8. Begin the workout.

SELECTING A WORKOUT MODE

Two workout mode options on the Total Body Trainer feature alternate ways to vary workouts.

- **Aerobics Mode:** This workout mode simulates the experience of working out with a trainer. Throughout the workout, the MESSAGE CENTER displays prompts to vary the workload and emphasize different muscle groups, such as upper- and lower-body. This feature can be used with any workout except for Fat Burn, Cardio, Heart Rate Hill, Heart Rate Interval, Extreme Heart Rate, or Stride Programs (97Xi only). To select it, press AEROBICS MODE key.

* Target Heart Rate (THR) is a percentage of the theoretical maximum. For example, a 40-year-old user's THR for the **HEART RATE HILL** workout is 144. This workout targets 80 percent of the maximum, so the equation would be $(220-40) \cdot 80 = 144$.

- **Reverse Mode:** This workout mode alternates forward motion with reverse motion to exercise different leg muscles. This feature can be used with any workout except for Fat Burn, Cardio, Heart Rate Hill, Heart Rate Interval, Extreme Heart Rate, or Stride Programs (97Xi only). To select it, press the REVERSE MODE key. For more detailed information, see Section 4.3 *Workout Descriptions, Cross-Train Reverse*.

SELECTING AND ADJUSTING STRIDE LENGTH (97Xi ONLY)

The Life Fitness 97Xi Select Stride Total Body Trainer provides a range of strides from 14" to 26" (36 to 66 cm). When beginning a workout, if the unit is at any stride length other than 20" (50.8 cm), the Message Center will display the message "Stride Adjusting to Middle Position" and the cross-trainer will reset itself to 20" (50.8 cm), the default position. The user may interrupt this process by pressing the ADJUST STRIDE arrow key.

To change stride length during any workout, use the ADJUST STRIDE arrow key to increase or decrease stride. The stride length indicator window will show the change as a lengthening or shortening of the row of lights and the desired stride length will show in the lower console window. For more information on Selecting and Adjusting Stride, see section 4.5 *Selecting Stride*.

SWITCHING WORKOUTS "ON-THE-FLY"

It is possible, during a workout, to switch to another workout program. After a switch, the console retains all the progress information about the workout since its beginning. To change workouts "on the fly," simply press the key for the desired new workout. This feature is available for all workouts except for Around the World, Kilimanjaro, Interval, Cascades, Speed Training, Foothills, and Personal Trainer workouts.

PAUSING WORKOUTS

To pause a workout, simply stop pedaling. To continue the workout, resume pedaling. The pause duration lasts 60 seconds, after which the console automatically shuts down.

ENDING WORKOUTS EARLY

To end a workout before the pre-set duration expires, press CLEAR once. The MESSAGE CENTER then displays a workout summary, which includes the distance travelled, the total calories burned, and other statistics. Press CLEAR a second time and the MESSAGE CENTER displays "SELECT WORKOUT OR PRESS QUICK START" for a new workout.

TOTAL BODY TRAINER WORKOUT SETUP STEPS

QUICK START

Press QUICK START
Begin workout

MANUAL

Press MANUAL
Enter weight
Enter time***
Select level
Begin workout

RANDOM

Press RANDOM
Enter weight
Enter time***
Select level
Begin workout

FAT BURN*

Press FAT BURN
Enter weight
Enter time***
Enter age
Accept THR**
Begin workout

CARDIO*

Press CARDIO
Enter weight
Enter time***
Enter age
Accept THR
Begin workout

HEART RATE HILL*

Press ZONE TRAINING+
repeatedly until HR HILL
appears; press ENTER
Enter weight
Enter time
Enter age
Accept THR
Begin workout

HEART RATE INTERVAL*

Press ZONE TRAINING+
repeatedly until HR
INTERVAL appears;
press ENTER
Enter weight
Enter time***
Enter age
Accept THR
Begin workout

EXTREME HEART RATE*

Press ZONE TRAINING+
repeatedly until
EXTREME HR appears;
press ENTER
Enter weight
Enter time***
Enter age
Accept THR
Begin workout

HILL

Press HILL PLUS; when
HILL appears, press
ENTER

Enter weight
Enter time***
Select level
Begin workout

AROUND THE WORLD

Press HILL PLUS repeatedly
until AROUND THE
WORLD Appears; press
ENTER
Enter weight
Enter time***
Select level
Begin workout

CASCADES

Press HILL PLUS repeated-
ly until
CASCADES appears;
press ENTER
Enter weight
Enter time***
Select level
Begin workout

FOOTHILLS

Press HILL PLUS repeated-
ly until FOOTHILLS
appears; press ENTER
Enter weight
Enter time***
Select level
Begin workout

INTERVAL

Press HILL PLUS repeated-
ly until INTERVAL
appears; press ENTER
Enter weight
Enter time***
Select level
Begin workout

KILIMANJARO

Press HILL PLUS repeated-
ly until KILIMANJARO
appears; press ENTER
Enter weight
Enter time***
Select level
Begin workout

SPEED TRAINING

Press HILL PLUS repeatedly
until SPEED TRAINING
appears; press ENTER
Enter weight
Enter time***
Select level
Begin workout

CROSS-TRAIN REVERSE

Press PERSONAL TRAINER
repeatedly until X-TRAIN
REVERSE appears;
press ENTER
Enter weight
Enter time***
Select level
Begin workout

CROSS-TRAIN AEROBICS

Press PERSONAL TRAIN-
ER repeatedly until X-
TRAIN
AEROBICS appears;
press ENTER
Enter weight
Enter time***
Select level
Begin workout

FIT TEST**

Press PERSONAL
TRAINER repeatedly
until FIT TEST
appears;
press ENTER
Enter weight
Enter age
Enter gender
Enter level
Begin workout

MOUNTAIN TREK (97Xi only)

Press STRIDE PRO-
GRAMS repeatedly
until MOUNTAIN TREK
appears;
press ENTER
Enter weight
Enter time***
Enter level
Begin workout

RANDOM PLAY (97Xi only)

Press STRIDE PRO-
GRAMS repeatedly
until RANDOM PLAY
appears;
press ENTER
Enter weight
Enter time***
Enter level
Begin workout

INTERVAL RUN (97Xi only)

Press STRIDE PRO-
GRAMS repeatedly
until INTERVAL RUN
appears;
press ENTER
Enter weight
Enter time***
Enter level
Begin workout

* This workout requires the user to wear the telemetry chest strap or to grip the Lifepulse system sensors.

** Target Heart Rate (THR) is a percentage of the theoretical maximum. For example, a 40-year-old user's THR for the FAT BURN workout is 117. This workout targets 65 percent of the maximum, so the equation would be $(220-40) \times .65 = 117$. When the MESSAGE CENTER displays a Target Heart Rate, either accept it by pressing ENTER, or change the value with the LEVEL ARROW key, and then press ENTER.

*** If a calorie or distance goal is being used, the MESSAGE CENTER does not display a prompt for a time duration.

4.3 WORKOUT DESCRIPTIONS

QUICK START

QUICK START is the fastest way to begin exercising and bypasses the steps of selecting a specific workout program. The intensity level for the workout is set automatically and remains the same unless manually changed. To change the level, use the LEVEL ARROW keys or use the NUMERIC KEYPAD to enter a higher or lower level number. After the workout has been in progress for 12 seconds, the MESSAGE CENTER displays “ENTER WEIGHT”, which the computer requires to calculate total calories. Using the ARROW KEYS, increase or decrease the displayed weight to the correct value (or enter the weight using the NUMERIC keypad).

MANUAL WORKOUT

The **MANUAL** program sets an intensity level that does not change automatically. While the workout is in progress, increase or lower the intensity level as desired using the ARROW keys.

RANDOM WORKOUT

The **RANDOM** program creates a terrain of hills and valleys that varies with each workout. More than one million different patterns are possible. Because workout levels are greater in this workout than in the **HILL** workout, it is recommended that the **RANDOM** workout be set one or two levels lower than the workout level which would normally be selected in the **HILL** workout.

FAT BURN

The **FAT BURN** workout is designed to maintain a user's heart rate at 65 percent of the theoretical maximum[†] for optimal results. Throughout the workout, the user wears a chest strap or grips the Lifepulse system sensors. If the user is not wearing a chest strap, the WORKOUT PROFILE window displays a heart shape and the MESSAGE CENTER displays a prompt to grip the sensors. The console continuously monitors and displays the heart rate, adjusting the intensity level of the Total Body Trainer to reach and maintain the target*. This system eliminates over- and under-training and maximizes the aerobic benefits of exercise by using the body's fat stores for fuel.

CARDIO

The **CARDIO** workout is virtually identical to **FAT BURN**, except the target heart rate is calculated at 80 percent of the theoretical maximum. As with **FAT BURN**, the user wears a chest strap or grips the Lifepulse system sensors throughout the **CARDIO** workout. The higher target promotes cardiovascular improvement by placing a heavier workload on the heart muscle.

[†] Defined by the American College of Sports Medicine's "Guidelines for Exercise Testing and Prescription" as equal to 220 minus an individual's age.

* Target Heart Rate (THR) is a percentage of the theoretical maximum. For example, a 40-year-old user's THR for the **FAT BURN** workout is 117. This workout targets 65 percent of the maximum, so the equation would be $(220-40) \cdot 65 = 117$.

HILL

The Life Fitness-patented **HILL** workout offers a variety of configurations for interval training. Intervals are periods of intense aerobic exercise separated by regular periods of lower-intensity exercise. The **WORKOUT PROFILE** window represents these high and low intervals as columns of light, which together have the appearance of hills and valleys. The computerized interval training workout has been scientifically demonstrated to promote greater cardio-respiratory improvement than steady-pace training.

Each **HILL** workout goes through four phases, each marked by different intensity levels. The **WORKOUT PROFILE** window displays the progress of these phases, as seen in the chart following these descriptions below. As noted in the descriptions, the heart rate should be measured at two stages in the workout to gauge its effectiveness. To do so, wear the chest strap or continuously grip the Lifepulse system sensors. Note that the **MESSAGE CENTER** does not display a request for a heart rate measurement during a **HILL** workout.

- 1 **Warm-up** is a phase of low, gradually-rising resistance, which brings the heart rate into the lower end of the target zone and increases respiration and blood flow to working muscles.
- 2 **Plateau** increases the intensity slightly, and keeps it steady, to bring the heart rate to the low end of the target zone. Check the heart rate at the end of this phase.
- 3 **Interval Training** is a series of increasingly steeper hills, alternating with valleys (or periods of recovery). The heart rate should rise to the high end of the target zone. Check the heart rate at the end of this phase.
- 4 **Cool-down** is a low-intensity phase that allows the body to begin removing lactic acid and other exercise by-products, which build up in muscles and contribute to soreness.

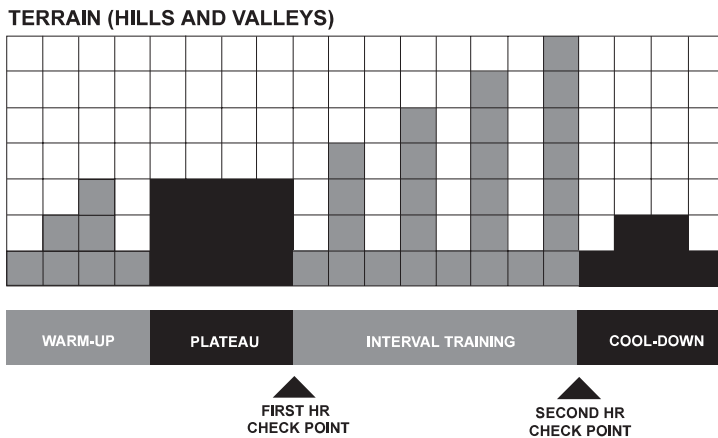

Each column, as seen in the **WORKOUT PROFILE** window and the chart above, represents one interval. The overall duration of the workout determines the length of each interval. Each workout is made up of 20 intervals, so the duration of each interval is equal to the duration of the entire workout divided by 20.

10 to 19 minutes: The interval durations initially are set at 30 seconds for a 10-minute workout. For every minute added by the user “on the fly,” each interval increases by three seconds. A 15-minute workout consists of 20 intervals at 45 seconds each.

20 to 99 minutes: All intervals last 60 seconds. If the user adds minutes to the pre-set duration while the workout is in progress, the program adds hills and valleys that are identical to the first eight intervals of the Interval Training phase. This pattern repeats until the workout is completed.

SIX PRE-SET WORKOUTS

AROUND THE WORLD, CASCADES, FOOTHILLS, INTERVAL, KILIMANJARO, and SPEED TRAINING are variations of the HILL workout. These workouts cannot be changed “on the fly.”

AROUND THE WORLD is an interval-training workout in which the hills resemble scenes of various geographical areas.

CASCADES is a two-peak workout in which intensity levels gradually increase and decrease.

FOOTHILLS is a rolling hill workout with low intensity levels.

INTERVAL is a Hill workout in which intensity levels rise and fall. The higher levels gradually incline toward a peak and then gradually decline.

KILIMANJARO is a Hill workout in which the intensity levels gradually incline toward one ultimate peak and then gradually decline.

SPEED TRAINING is a Hill workout in which the intensity level alternates between high and low levels very quickly to simulate a typical speed training workout.

HEART RATE HILL™

This program combines the standard **HILL** workout profile with the concept of Heart Rate Zone Training. The default target heart rate* is calculated as 80 percent of the theoretical maximum† (HRmax), but the user can adjust the target rate during the workout setup. All hills and valleys are percentages of HRmax. The workout consists of three hills that target three heart rate goals: The first hill brings the heart rate to 70 percent of HRmax. The second hill increases the rate to 75 percent of HRmax. The third hill matches the Target Heart Rate bringing the heart rate to 80 percent of HRmax. The valley always is defined as 65 percent of HRmax.

After a standard three-minute warm-up, the workout progresses toward the first hill and heart rate goal. Once the user reaches 70 percent of HRmax, the hill continues for one minute. When the minute expires, the level decreases into a valley. Once the user's heart rate falls to 65 percent of HRmax, the valley continues for one minute. Then the next hill begins with its corresponding heart rate goal. After the user completes the third hill/valley pair, the program returns to the first hill and repeats the cycle as long as the duration allows. At the end of the duration, the workout goes into a cool-down phase. If the heart rate goes above the theoretical maximum for more than 45 seconds, the cross-trainer automatically goes into pause mode. The program does not proceed to a new heart rate goal until the user reaches the current goal. The user must wear a heart rate chest strap or grip the Lifepulse sensors throughout the workout.

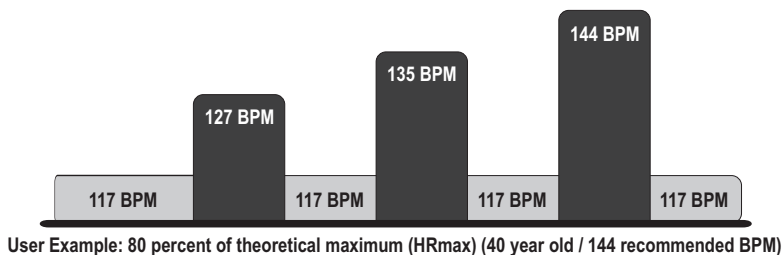
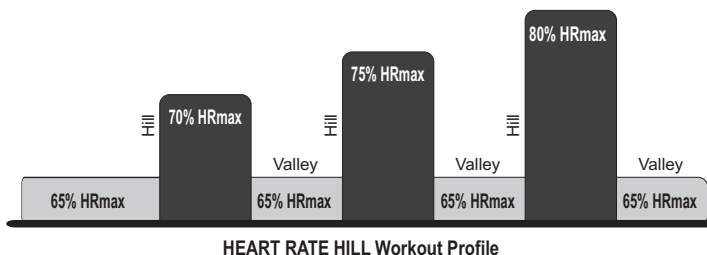

† Defined by the American College of Sports Medicine's "Guidelines for Exercise Testing and Prescription" as equal to 220 minus an individual's age.

* Target Heart Rate (THR) is a percentage of the theoretical maximum (HRmax). A 40-year-old user's recommended THR for the HEART RATE HILL workout is 144, or 80 percent of the maximum; so the equation would be $(220-40) \cdot 80 = 144$.

HEART RATE INTERVAL™

This program also combines the standard **HILL** workout profile with the concept of Heart Rate Zone Training. The default target heart rate* is calculated as 80 percent of the theoretical maximum† (HRmax), but the user can adjust the target rate during the workout setup. The workout alternates between a hill, which brings the heart rate up to the target rate of 80 percent of HRmax, and a valley, which brings the heart rate down to 65 percent of HRmax. After a standard three-minute warm-up, the workout progresses toward the first hill and heart rate goal. Once the goal is reached, the hill continues for three minutes. Then the level decreases into a valley. Once the 65 percent of HRmax goal is reached, the valley continues for three minutes, after which the next hill begins. The user's fitness level determines the number of hills and valleys encountered within the duration. At the end of the duration, the workout goes into a cool-down phase. If the heart rate goes above the theoretical maximum† for more than 45 seconds, the cross-trainer automatically goes into pause mode. The program does not proceed to a new heart rate goal until the user reaches the current goal. The user must wear a heart rate chest strap or grip the Lifepulse sensors throughout the workout.

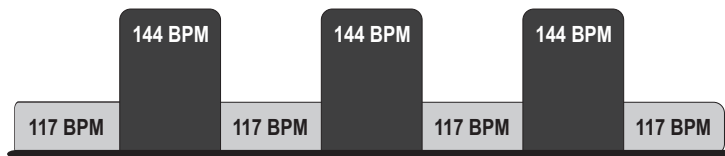
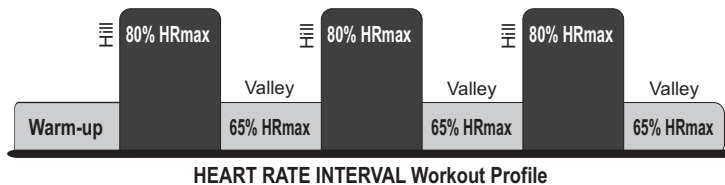

User Example: 80 percent of theoretical maximum (HRmax) (40 year old / 144 recommended BPM)

† Defined by the American College of Sports Medicine's "Guidelines for Exercise Testing and Prescription" as equal to 220 minus an individual's age.

* Target Heart Rate (THR) is a percentage of the theoretical maximum (HRmax). A 40-year-old user's recommended THR for the HEART RATE INTERVAL workout is 144, or 80 percent of the maximum; so the equation would be $(220-40) \cdot 80 = 144$.

EXTREME HEART RATE™

This intense, varied workout is designed to help more experienced users break through fitness improvement plateaus. The workout alternates between two target heart rates* as quickly as possible. The effect is similar to that of running sprints. The user must wear a chest strap or grip the Lifepulse™ sensors throughout the workout.

When setting up the workout, the user enters a target heart rate. After a standard three-minute warm-up, the intensity increases, until the user reaches the target heart rate goal of 85 percent of the theoretical maximum† (HRmax). That target rate is maintained for a stabilizing period. Then, the intensity decreases. When the heart rate falls to the 65 percent of HRmax goal, it is maintained there for a stabilizing period. The program repeats the alternating of intensity levels, continuing this pattern throughout the duration. The program does not proceed to a new heart rate goal until the user reaches the current goal.

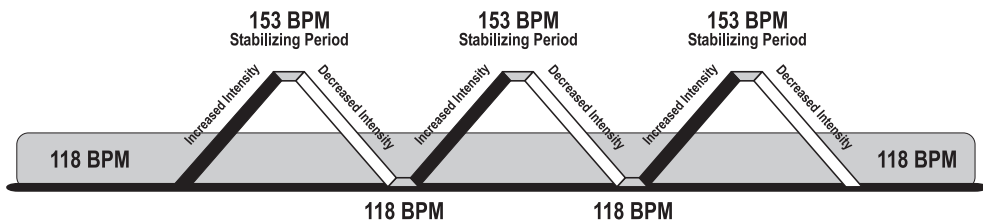
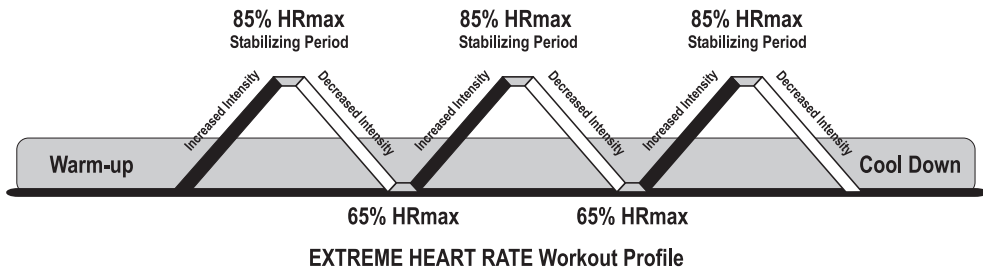

User Example 85 percent of theoretical maximum (HRmax) (40 year old / 153 recommended BPM)

† Defined by the American College of Sports Medicine's "Guidelines for Exercise Testing and Prescription" as equal to 220 minus an individual's age.

* Target Heart Rate (THR) is a percentage of the theoretical maximum (HRmax). For example, a 40-year-old user's recommended THR for the EXTREME HEART RATE™ WORKOUT is 153. The workout program targets a standard 85 percent of the maximum, so the equation would be $(220-40) \cdot 85 = 153$.

CROSS-TRAIN AEROBICS

During this workout, the MESSAGE CENTER displays prompts to emphasize different muscle groups. To emphasize upper-body muscles, the MESSAGE CENTER displays prompts to focus on pushing and pulling the moving arms at various times. To emphasize lower-body muscles, the MESSAGE CENTER displays prompts to rest the hands on the stationary handlebar, thus forcing the legs to do all the work. The program also alternates between forward and reverse motion as well as different speeds.

Ten seconds after prompting the user to change pedaling direction, the workout applies “braking resistance,” that is, a high resistance level that essentially forces the user to stop pedaling. Once the user stops pedaling, the workout resumes the normal resistance level. The actual level of breaking resistance depends on the user’s pedaling speed. If the user is pedaling at a rate equal to, or faster than 6.2 mph (10.0 km/h), the workout applies the maximum level of braking resistance. If the user is pedaling at a speed below 6.2 mph (10.0 km/h), the workout applies 92 percent of the maximum.

CROSS-TRAIN AEROBICS is a constant-resistance workout. However, for a similar experience with a variable-resistance-level workout, the user can start any workout (except for Fat Burn, Cardio, Heart Rate Hill, Heart Rate Interval, or Extreme Heart Rate, or Stride Programs [97Xi only]) and then press the AEROBICS MODE key.

CROSS-TRAIN REVERSE

This workout features alternating periods of pedaling forward and pedaling backwards. If the user chooses a workout duration 14 minutes or above, the unit displays alternating prompts to pedal forward for five minutes and then backward for two minutes. If the user selects a goal of 13 minutes or below, the display prompts the user to pedal forward for two minutes and then backward for one minute. If the user selects a goal other than time (distance or calorie), the program uses the default setting of prompting forward motion for five minutes and reverse for two minutes.

This feature varies the emphasis on different leg muscles. Ten seconds after prompting the user to change pedaling direction, the workout applies “braking resistance,” that is, a high resistance level that essentially forces the user to stop pedaling. Once the user stops pedaling, the workout resumes the normal resistance level. The actual level of breaking resistance depends on the user’s pedaling SPEED. If the user is pedaling at a rate equal to, or faster than, 6.2 mph (10.0 km/h), the workout applies the maximum level of braking resistance. If the user is pedaling at a speed below 6.2 mph (10.0 km/h), the workout applies 92 percent of the maximum.

CROSS-TRAIN REVERSE is a constant-resistance workout. However, for a similar experience with a variable-resistance-level workout, the user can start any workout (except for Fat Burn, Cardio, Heart Rate Hill, Heart Rate Interval, or Extreme Heart Rate, or Stride Programs [97Xi only]) and then press the REVERSE MODE key.

FIT TEST

The Total Body Trainer Fit Test program is another exclusive feature of this versatile cross-trainer. The Fit Test workout measures cardiovascular fitness and can be used to monitor improvements in endurance every four to six weeks. The user must grasp the Lifepulse hand sensors when prompted or wear a heart rate chest strap, as the test score calculation is based on a heart rate reading. The workout duration will be five minutes at the chosen resistance level. Immediately afterward, the console will take the user's heart rate reading, calculate a fitness score, and display the score in the MESSAGE CENTER.

The Fit Test is considered to be a submax VO₂ (volume of oxygen) test. It gauges how well the heart supplies oxygenated blood to the exercising muscles, and how efficiently those muscles receive oxygen from the blood. Physicians and exercise physiologists generally regard this test as a good measure of aerobic capacity.

To set up the Fit Test:

- Begin pedaling.
- Press the PERSONAL TRAINER button repeatedly until the FIT TEST option appears in the message center. Press ENTER to select the FIT TEST option.
- The message center will prompt for a user weight (ENTER WEIGHT). Use the NUMERIC KEYS or UP/DOWN ARROW KEYS to input your weight. Press ENTER to accept the weight.
- The message center will next prompt for a user age (ENTER AGE). Use the NUMERIC KEYS or UP/DOWN ARROW KEYS to input your age. Press ENTER to accept the age.
- The message center will next prompt for a user gender (SELECT GENDER). Using the UP/DOWN ARROW KEYS, select a gender. Press ENTER to accept the gender selection.
- The message center will next prompt for a workout level (ENTER LEVEL). Consult the following recommended fit test level chart for an appropriate effort level based on your age, gender and activity level. Use the NUMERIC KEYS or UP/DOWN ARROW KEYS to enter the corresponding level.
- As the test continues, a message will prompt the user to maintain a pedaling rate between 50-60 rpm (equivalent to 4.2-5.5 mph). The user must maintain this rate throughout the 5-minute test duration. After 16 seconds, if 50-60 rpm is not maintained, the fit test will automatically terminate.

After the five-minute FIT TEST is completed, a FIT TEST score will be displayed.

FIT TEST PROGRAM SUGGESTED EXERTION LEVELS

	Inactive	Active	Very Active
Cross-Trainer Fit Test Level	L2-4 men	L3-10 men	L7-15 men
	L1-2 women	L2-5 women	L3-10 women

Suggested exertion levels should be used as a guideline for setting up the Fit Test program. The goal is to elevate the user's heart rate to a level that is between 60%-85% of their theoretical maximum heart rate[†].

Within each suggested range, these additional guidelines can be used:

Lower Half of Range	Upper Half of Range
higher age	lower age
lower weight	higher weight*
shorter	taller

* in cases of excessive weight, use lower half of range

[†] Defined by the American College of Sports Medicine's "Guidelines for Exercise Testing and Prescription" as equal to 220 minus an individual's age.

The computer will not accept:

- heart rates less than 52 or greater than 200 beats per minute
- body weights less than 75 pounds (34 kg) or greater than 400 pounds (182 kg)
- ages below 10 or over 99 years
- data input that exceeds human potential

If you make an error when entering any Fit Test data, you can correct it by pressing CLEAR, inputting the correct information, and pressing ENTER.

It is important for you to take the Fit Test under similar circumstances each time. Your heart rate is dependent on many factors, including:

- amount of sleep the previous night (at least seven hours is recommended)
- time of day
- time since last meal (two to four hours after the last meal is recommended)
- time since last beverage containing caffeine or alcohol, or cigarette (at least four hours is recommended)
- time since last exercise (at least six hours is recommended)

For the most accurate Fit Test results, perform the Fit Test on three consecutive days and average the three scores.

NOTE: To receive a proper Fit Test score, the work done must be within a training heart rate zone that is 60 percent to 85 percent of the theoretical maximum heart rate. This rate is defined by the American College of Sports Medicine's "Guidelines for Exercise Testing and Prescription" as equal to 220 minus an individual's age.

The tables below list fit test results.

RELATIVE FITNESS CLASSIFICATION FOR MEN

Men	Estimated VO2 Max (ml/kg/min) Per Age Category				
Rating	20-29	30-39	40-49	50-59	60+
Elite	52+	51+	48+	45+	42+
Excellent	50-51	48-50	46-47	42-44	39-41
Very Good	47-49	45-47	43-45	40-41	36-38
Above Average	44-46	42-44	40-42	37-39	33-35
Average	41-43	39-41	37-39	34-36	30-32
Below Average	38-40	36-38	34-36	31-33	27-29
Low	35-37	33-35	31-33	28-30	24-26
Very Low	<35	<33	<31	<28	<24

RELATIVE FITNESS CLASSIFICATION FOR WOMEN

Women	Estimated VO2 Max (ml/kg/min) Per Age Category				
Rating	20-29	30-39	40-49	50-59	60+
Elite	44+	42+	39+	35+	34+
Excellent	42-43	40-41	37-38	33-34	32-33
Very Good	39-41	37-39	35-36	31-32	30-31
Above Average	37-38	35-36	32-34	29-30	28-29
Average	34-36	32-34	30-31	27-28	25-27
Below Average	31-33	29-31	27-29	25-26	23-24
Low	28-30	27-28	25-26	22-24	20-22
Very Low	<28	<27	<25	<22	<20

Life Fitness developed this rating scale based on VO2 max percentile distributions referenced in *American College of Sports Medicine's "Guidelines for Exercise Testing and Prescription"* (6th Ed. 2000). It is designed to provide a qualitative description of a user's VO2 max estimation, and a means of assessing initial fitness level and tracking improvement.

4.5 SELECTING STRIDE (97Xi ONLY)

The Life Fitness 97Xi Select Stride Total Body Trainer offers a whole new level of functionality and flexibility to the exerciser. By adding stride adjustments to a workout, the user gains variety as well as the ability to tailor his or her workout to specific needs and goals. For example, the beginner may utilize the stride length feature to build up flexibility. Athletes may use specific stride lengths to simulate the needs of their sports activities. Personal trainers can utilize stride length in their training plans for their clients to emphasize specific fitness goals. Stride length can also be added to other Life Fitness workouts for variety and to keep workouts challenging and interesting.

The Life Fitness 97Xi Select Stride Total Body Trainer provides a range of strides from 14" to 26" (36 to 66 cm), with a default starting stride length of 20" (50.8 cm), the same stride length found on Life Fitness Fit Stride Total Body Trainers. When beginning a workout, if the unit is at any stride length other than 20" (50.8 cm), the Message Center will display the message "Stride Adjusting to Middle Position" and the cross-trainer will reset itself to 20" (50.8 cm), the default position. The unit adjusts to this default position so that programs can be utilized correctly and safely by the widest number of users. The exerciser may interrupt this process by pressing the Adjust Stride arrow key if desired.

To change stride length during a workout, use the ADJUST STRIDE arrow key to increase or decrease stride. The STRIDE LENGTH INDICATOR WINDOW, found just below the Message Center, will show the change as a lengthening or shortening of the row of lights with a blinking light indicating the direction (longer or shorter) of the stride change. In addition, the desired (target) stride length will be shown in the lower console window along with an "S," indicating "Stride." Once a desired stride length has been entered with the ADJUST STRIDE arrow key (or once an automatic adjustment takes place within a Stride Program), motors will engage to lengthen or shorten the stride length accordingly without further input from the user. Once the desired stride length has been reached, the stride adjustment motors stop until another stride length change occurs within a program or the exerciser chooses another stride length using the ADJUST STRIDE arrow key.

The stride adjustment feature on this cross-trainer has been designed to accommodate the widest possible range of body sizes and heights, while offering the benefits of walking and running with little or no impact on the joints.

The following guidelines can be used to select an appropriate stride length:

Length	Stride	User Height	Fitness	Flexibility	Motion
14-17"	Short	Shorter	Inactive	Low	Stepping
18-22"	Medium	Average	Active	Average	Walking/Jogging
23-26"	Long	Taller	Very Active	Hlgh	Running/Sprinting

It is important to note that user height does not necessarily correlate to a shorter stride length. A shorter person who performs sprints may wish to use a longer stride, while a taller person wishing to simulate more of a stair-climbing motion may choose a shorter stride. Consideration should be given to individual fitness goals when choosing the appropriate stride length, while maintaining a safe and comfortable range of motion throughout the workout.

NOTE: If at any time while exercising, the user experiences faintness, dizziness, pain, or shortness of breath, he or she must stop immediately. In addition, if the user experiences discomfort or pain at a specific stride length, the user must stop pedaling or adjust the stride length accordingly until the pain or discomfort disappears.

MOUNTAIN TREK (97Xi ONLY)

The Life Fitness patent-pending Mountain Trek program offers interval training based on resistance and stride length. The program simulates the hiking of two hills (or mountains), with periods of high resistance and shorter strides and periods of lower resistance with longer strides. The Workout Profile window represents these high and low intervals as columns of light, which together have the appearance of hills and valleys. The computerized interval training workout has been scientifically demonstrated to promote greater cardio-respiratory improvement than steady-pace training.

The Mountain Trek workout begins with a warm-up period. If the exerciser begins the program at any stride other than 16" (40.6 cm), the stride length will adjust automatically to the 16" (40.6 cm) position. The warm-up period is followed by the training portion of the workout, which alternates between 16" (40.6 cm) stride length and high resistance (representing the uphill climbs) and 24" (61 cm) stride length and lower resistance (representing the downhill portions). The stride length automatically changes with each peak and valley. The frequency of the stride changes is determined by the total duration of the workout entered during setup. Resistance changes with the stride length, increasing as the stride shortens and decreasing as the stride lengthens. The resistance level entered during setup represents the resistance during the downhill portion of the workout. During the uphill portion, the resistance doubles. Therefore, because of the higher levels found in the uphill phases, it is recommended that the Mountain Trek workout be set one or two levels lower than the workout level normally selected for a Hill workout.

The minimum workout duration is 10 minutes. Upon Cooldown, if the stride length is lower than 17" (43.2 cm) or greater than 22" (55.9 cm), the unit will return to the default position of 20" (50.8 cm). If the stride length is between 17" and 22" (43.2 - 55.9 cm), it will remain at that stride for the Cooldown period.

If at any time during the workout, the user wishes to change to another program from Mountain Trek, this change can be made "on the fly."

RANDOM PLAY (97Xi ONLY)

The Life Fitness patent-pending Random Play program creates a terrain of hills and valleys that varies with each workout, similar to the Random program. Hill profile, resistance levels and stride length change based on time, independently of each other.

Stride length changes randomly up or down after the first minute of the workout and every two minutes thereafter, while resistance changes (again, randomly up or down) at the minute intervals between stride changes. For example, if the stride changes at minute four during a workout, the resistance will change at minute five.

The minimum workout duration is 10 minutes, while the maximum workout time is 60 minutes. The user inputs a maximum level for the program, which determines the range for resistance during the workout. Because the levels of the Random Play workout are greater than in a standard Hill workout, it is recommended that the Random Play workout be set one or two levels lower than the workout level normally selected for a Hill workout.

Upon Cooldown, if the stride length is lower than 17" (43.2 cm) or greater than 22" (55.9 cm), the unit will return to the default position of 20" (50.8 cm). If the stride length is between 17" and 22" (43.2 - 55.9 cm), it will remain at that stride for the Cooldown period.

INTERVAL RUN (97Xi ONLY)

The Life Fitness patent-pending Interval Run program simulates interval training for runners. Using stride changes and Message Center prompts, the Interval Run program mimics performing sprints with a personal trainer. The computerized interval training workout has been scientifically demonstrated to promote greater cardio-respiratory improvement than steady-pace training.

The Interval Run workout begins with a three-minute warm-up period, during which the stride length remains at 22" (55.9 cm). The warm-up period is followed by the interval training portion of the workout, which alternates between a 24" (61 cm) stride length for approximately two minutes and a 26" (66 cm) stride length for approximately five minutes. The Message Center will display messages, prompting the user to "Go Faster" as the stride length increases or "Go Slower" as the stride length shortens.

The minimum workout duration is 10 minutes. The intervals will repeat for the chosen duration of the program, with the user selecting the maximum resistance level for the program during setup.

Upon Cooldown, if the stride length is lower than 17" (43.2 cm) or greater than 22" (55.9 cm), the unit will return to the default position of 20" (50.8 cm). If the stride length is between 17" and 22" (43.2 - 55.9 cm), it will remain at that stride for the Cooldown period.

If switching "on the fly" from another program, the Interval Run workout will go directly into the interval phase, skipping the warm-up. Users can also switch to other programs from Interval Run "on-the-fly."

5 OPTIONAL SETTINGS

5.1 ENTERING AND USING THE OPTIONAL SETTINGS FEATURE

Fitness club managers and other authorized personnel can use the Optional Settings feature to change default settings or to enable or disable certain workouts or displays on the Total Body Trainer console.

To enter the Optional Settings, while the unit is on, hold down the 5 key and press CLEAR twice. The MESSAGE CENTER displays "OPTIONAL SETTINGS" and then the first configuration option. Scroll forward through the options using the ENTER key or backward using the CLEAR key. For each feature or setting option, the MESSAGE CENTER displays the default setting. To change the default, press the UP or DOWN ARROW key for the desired value. Press ENTER to select the new value or setting. To exit Optional Settings, press the CLEAR key repeatedly until the MESSAGE CENTER displays "SELECT WORKOUT OR PRESS QUICK START".

OPTIONAL SETTINGS		
Setting	Default Value	Description
MAX WORKOUT DURATION	60 minutes	This is the maximum possible duration for a workout. The value can range from 10 to 99.
ENGLISH/METRIC UNITS	ENGLISH	This option determines the units used for entering weight and measuring distance.
WATTS DISPLAY ENABLE/DISABLE	DISABLED	If this option is enabled, the MESSAGE CENTER displays the of Watts equivalent pedaling rate.
METS DISPLAY ENABLE/DISABLE	DISABLED	If this option is enabled, the MESSAGE CENTER displays the METs equivalent of the pedaling rate.
CAL/HR DISPLAY ENABLE/DISABLE	DISABLED	If this option is enabled, the MESSAGE CENTER displays the number of calories burned per hour during the workout.

6 SERVICE AND TECHNICAL DATA

6.1 PREVENTIVE MAINTENANCE TIPS

The Total Body Trainer is backed by the engineering excellence of Life Fitness and is one of the most rugged and trouble-free pieces of exercise equipment on the market today. Commercial Life Fitness products have proven to be durable in health clubs, colleges, and military facilities the world over. This same technology, engineering expertise, and reliability have gone into the Total Body Trainer.

NOTE: The safety of the equipment can be maintained only if the equipment is examined regularly for damage or wear. Keep the equipment out of use until defective parts are repaired or replaced. Pay special attention to parts that are subject to wear as outlined in the Preventive Maintenance Schedule.

REMARQUE : pour conserver un matériel sûr, il convient de l'inspecter régulièrement afin de déceler tout signe d'usure ou d'endommagement. N'utilisez pas l'appareil tant que les pièces défectueuses n'ont pas été réparées ou remplacées. Portez une attention toute particulière aux pièces qui s'usent, comme indiqué ci-dessous.

The following preventive maintenance tips will keep your Total Body Trainer operating at peak performance:

- Locate the Total Body Trainer in a cool, dry place.
- Clean the top surface of the pedals regularly.
- Keep the display console free of fingerprints and salt build-up caused by sweat.
- Use a 100% cotton cloth, lightly moistened with water and mild liquid detergent, to clean the Total Body Trainer. Other fabrics, including paper towels, may scratch the surface. Do not use ammonia, chlorine, or acid-based cleaners.
- Long fingernails may damage or scratch the surface of the console; use the pad of the finger to press the selection buttons on the console.
- Clean the housing and moving arms thoroughly on a regular basis.



NOTE: When cleaning the exterior of the unit, a non-abrasive cleaner and soft cotton cloth are strongly recommended. At no time should cleaner be applied directly to any part of the equipment; apply the non-abrasive cleaner on a soft cloth and then wipe the unit.

6.2 PREVENTIVE MAINTENANCE SCHEDULE

Follow the schedule below to ensure proper operation of the product.

ITEM	WEEKLY	MONTHLY	BI-ANNUALLY	ANNUALLY
<i>Display Console</i>	<i>Clean</i>	<i>Inspect</i>		
<i>Console Mounting Bolts</i>			<i>Inspect</i>	
<i>Accessory Tray</i>	<i>Clean</i>	<i>Inspect</i>		
<i>Frame</i>	<i>Clean</i>			<i>Inspect</i>
<i>Plastic Covers</i>	<i>Clean</i>	<i>Inspect</i>		

6.3 TROUBLESHOOTING THE POLAR® HEART RATE CHEST STRAP

HEART RATE READING IS ERRATIC, ABSENT ENTIRELY, OR ABNORMALLY ELEVATED

Malfunction	Probable Cause	Corrective Action
Heart rate reading is erratic or absent entirely	Belt transmitter electrodes are not wet enough to pick up accurate heart rate readings.	Wet the belt transmitter electrodes (see section 3.2).
	Belt transmitter electrodes are not laying flat against the skin.	Ensure the belt transmitter electrodes are laying flat against the skin (see section 3.2).
	Belt transmitter needs cleaning.	Wash the belt transmitter with mild soap and water.
	Belt transmitter is not within 3 feet (one meter) of the heart rate receiver.	Make sure the chest strap transmitter is within three feet (one meter) of the heart rate receiver.
	Chest strap battery is depleted.	Contact Life Fitness Customer Support Services* for instructions on how to have the chest strap replaced.
Abnormally elevated heart rate readings	Electromagnetic interference from television sets and/or antennas.	Move the cross-trainer a few inches away from the probable cause, or move the probable cause a few inches away from the cross-trainer, until the heart rate readings are accurate.
	Electromagnetic interference from cell phones.	
	Electromagnetic interference from computers.	
	Electromagnetic interference from cars.	
	Electromagnetic interference from high voltage power lines.	
	Electromagnetic interference from motor driven exercise equipment.	
	Electromagnetic interference from another heart rate transmitter within three feet (one meter).	

6.4 TROUBLESHOOTING THE LIFEPULSE SYSTEM SENSORS

If the heart rate reading is erratic or missing, do the following:

- Dry the hands if necessary to prevent slipping.
- Apply hands to all four sensors, located at the front and back of the hand grips.
- Grasp the sensors firmly.
- Apply constant pressure around the sensors.

6.5 TROUBLESHOOTING THE STRIDE ADJUSTMENT MECHANISM

If the stride mechanism is not properly functioning, do the following:

- End the workout, clearing out the previous workout setup, and attempt to begin the workout again.
- If the stride adjustment mechanism is still not functioning, contact Life Fitness Customer Support Services.

6.6 HOW TO OBTAIN PRODUCT SERVICE

1. Verify the symptom and review the operating instructions. The problem may be unfamiliarity with the product and its features and workouts.
2. Locate the serial number plate, which is at the back end of the unit. Document the serial number, which consists of three letters followed by six numerals.
3. Contact Life Fitness Customer Support Services via the Web at: www.lifefitness.com, or call the nearest Life Fitness Customer Support Services group:

For Product Service within
the United States and Canada:

Telephone: (+1) 847.451.0036
FAX: (+1) 847.288.3702
Toll-free telephone: 800.351.3737

For Product Service Internationally:

Life Fitness Europe GmbH
Telephone: (+49) 089.317.751.66
FAX: (+49) 089.317.751.38

Life Fitness (UK) LTD
Telephone: (+44) 1353.665.507
FAX: (+44) 1353.666.719

*Life Fitness Atlantic BV (Europe, Middle
East & Africa except local Life Fitness
offices)*

Life Fitness Benelux
Telephone: (+31) 180.646.666
FAX: (+31) 180.646.699

Life Fitness Italia S.R.L.
Telephone: 800.438.836
FAX: (+39) 0457.238.197

Life Fitness Austria Vertriebs GmbH
Telephone: (+43) 1615.7198
FAX: (+43) 1615.7198.20

*Life Fitness Asia Pacific Ltd (Asia &
Australia, except local Life Fitness offices)*
Telephone: (+852) 2891.6677
FAX: (+852) 2575.6001

*Life Fitness Latin America
and Caribbean*
Telephone: (+1) 847.288.3964
FAX: (+1) 847.288.3886

Life Fitness do Brazil
Telephone (+55) 11.4193.8282
FAX: (+55) 11.4193.8283

Life Fitness Japan
Telephone: (+81) 3.3359.4309
FAX: (+81) 3.3359.4307

Life Fitness Iberia (Spain)
Telephone : (+34) 93.672.4660
FAX : (+34) 93.672.4670

7 SPECIFICATIONS

7.1 LIFE FITNESS 97Xi SELECT STRIDE™ TOTAL BODY TRAINER

Designed use:	Heavy/Commercial
Maximum user weight:	350 pounds / 160 kilograms
Power requirements:	None.
Console:	MESSAGE CENTER with numeric keypad and arrow keys. STRIDE LENGTH INDICATOR window with dedicated arrow keys.
Displays:	Elapsed time, Speed, level, calories, heart rate, and distance, and stride length. When enabled: calories burned per hour, METS, and watts*.
Summaries:	Total elapsed time of workout, total calories burned, total distance
Character size:	0.54 inches
Workouts and Goals:	Manual, Random, Hill, Cross-Train Aerobics, Cross-Train Reverse, Fat Burn, Cardio, Heart Rate Hill, Heart Rate Interval, Extreme Heart Rate, Around the World, Cascades, Foothills, Kilimanjaro, Interval, Speed Training, Personal Trainer Workouts (6 slots), Time in Zone Goal, Calories Goal, Distance Goal, Quick Start, Mountain Trek, Random Play, and Interval Run.
Modes:	Aerobics and Reverse modes during all workouts except for Fat Burn, Cardio, Heart Rate Hill, Heart Rate Interval, Extreme Heart Rate or Stride Programs.
Heart rate monitor:	Polar® telemetry heart rate monitoring system. Lifepulse system sensors. Polar® heart rate chest strap: optional
Resistance Levels:	25 (speed-independent)
Pedal speed range:	1.5 mph-14.3 mph (2.4 km/h-23.0 km/h)
Drive type:	Belt/alternator
Accessory Tray:	Standard
Integrated Reading Rack:	Standard
Color:	Silver with gray accents

PHYSICAL DIMENSIONS:

Length:	84.75 inches / 215 centimeters
Width:	26.5 inches / 67 centimeters
Height:	64 inches / 162.5 centimeters
Weight:	310 pounds / 141 kilograms

SHIPPING DIMENSIONS:

Length:	85.75 inches / 217.8 centimeters
Width:	29.75 inches / 75.6 centimeters
Height:	50.75 inches / 128.9 centimeters
Weight:	390 pounds / 176.9

For EN 957-9 class A accuracy testing, input mechanical power was measured by connecting a cross-trainer to a fixture consisting of a motor and gear box with an attached torque transducer, amplifier, and readout display. Testing was done by removing the pedal lever from one side of the cross trainer and connecting the test fixture in place of the pedal lever at the crank axis. Torque measurements were taken with and without the pedal lever installed on the other side of the cross-trainer in order to determine the level of measured torque required to compensate for the missing pedal lever. From measured torque and speed, the input mechanical power and variance from displayed power were calculated. At level 9 and a constant 50 RPM, displayed wattage was 92 watts, with a 0.6% variance from the input power measured on the test equipment. At level 9 and a constant 60 RPM, displayed wattage was 111 watts, with a 2.2% variance from measured input power.

7.2 LIFE FITNESS 95Xi FIT STRIDE™ TOTAL BODY TRAINER

Designed use:	Heavy/Commercial
Maximum user weight:	350 pounds / 160 kilograms
Power requirements:	None.
Console:	MESSAGE CENTER with numeric keypad and arrow keys.
Displays:	Elapsed time, Speed, level, calories, heart rate, and distance. When enabled: calories burned per hour, METS, and watts*.
Summaries:	Total elapsed time of workout, total calories burned, total distance
Character size:	0.54 inches
Workouts and Goals:	Manual, Random, Hill, Cross-Train Aerobics, Cross-Train Reverse, Fat Burn, Cardio, Heart Rate Hill, Heart Rate Interval, Extreme Heart Rate, Around the World, Cascades, Foothills, Kilimanjaro, Interval, Speed Training, Time in Zone Goal, Calories Goal, Distance Goal, Quick Start
Modes:	Aerobics and Reverse modes during all workouts except for Fat Burn, Cardio, Heart Rate Hill, Heart Rate Interval, or Extreme Heart Rate
Heart rate monitor:	Polar® telemetry heart rate monitoring system Lifepulse system sensors Polar® heart rate chest strap: optional
Resistance Levels:	25 (speed independent)
Pedal speed range:	1.5 mph-14.3 mph (2.4 km/h-23.0 km/h)
Drive type:	Belt/alternator
Accessory Tray:	Standard
Integrated Reading Rack:	Standard
Color:	Silver with gray accents

PHYSICAL DIMENSIONS:

Length:	84.75 inches / 215 centimeters
Width:	26.5 inches / 67 centimeters
Height:	64 inches / 162.5 centimeters
Weight:	286 pounds / 130 kilograms

SHIPPING DIMENSIONS:

Length:	85.75 inches / 217.8 centimeters
Width:	29.25 inches / 74.3 centimeters
Height:	50.75 inches / 128.9 centimeters
Weight:	390 pounds / 176.9 kilograms

For EN 957-9 class A accuracy testing, input mechanical power was measured by connecting a cross-trainer to a fixture consisting of a motor and gear box with an attached torque transducer, amplifier, and readout display. Testing was done by removing the pedal lever from one side of the cross trainer and connecting the test fixture in place of the pedal lever at the crank axis. Torque measurements were taken with and without the pedal lever installed on the other side of the cross-trainer in order to determine the level of measured torque required to compensate for the missing pedal lever. From measured torque and speed, the input mechanical power and variance from displayed power were calculated. At level 9 and a constant 50 RPM, displayed wattage was 92 watts, with a 0.6% variance from the input power measured on the test equipment. At level 9 and a constant 60 RPM, displayed wattage was 111 watts, with a 2.2% variance from measured input power.

M051-00K62-A010