

***935, 905 Stairclimbers***  
operation manual



*LifeFitness*

## **CORPORATE HEADQUARTERS**

10601 West Belmont Avenue  
Franklin Park, Illinois 60131 • U.S.A.  
847.288.3300 • FAX: 847.288.3703  
800.735.3867 (Toll-free within U.S.A., Canada)

[www.lifefitness.com](http://www.lifefitness.com)

## **INTERNATIONAL OFFICES**

### **LIFE FITNESS ASIA PACIFIC LTD**

Room 2610, Miramar Tower  
132 Nathan Road  
Tsimshatsui, Kowloon  
HONG KONG  
Telephone: (+852) 2891.6677  
FAX: (+852) 2575.6001

### **LIFE FITNESS ATLANTIC BV LIFE FITNESS BENELUX**

Bijdorpplein 25-31  
2992 LB Barendrecht  
THE NETHERLANDS  
Telephone: (+31) 180.646.666  
FAX: (+31) 180.646.699  
Telephone: (+32) 87.300.942  
FAX: (+32) 87.300.943

### **LIFE FITNESS DO BRAZIL**

Av. Dr. Dib Sauaia Neto 1478  
Alphaville, Barueri, SP  
06465-140  
BRAZIL  
Telephone (+55) 11.4193.8282  
FAX: (+55) 11.4193.8283

### **LIFE FITNESS VERTRIEBS GMBH**

Dückerstraße 7-9/3/36  
1220 Vienna  
AUSTRIA  
Telephone: (+43) 1.61 57 198  
FAX: (+43) 1.61 57 198.20

### **LIFE FITNESS IBERIA**

Pol. Ind. Molí dels Frares. c/C, nº 12  
08620 Sant Vicenç dels Horts (Barcelona)  
SPAIN  
Telephone: (+34) 93.672.4660  
FAX: (+34) 93.672.4670

### **LIFE FITNESS EUROPE GMBH**

Siemensstrasse 3  
85716 Unterschleissheim  
GERMANY  
Telephone: (+49) 89.31 77 51.0  
FAX: (+49) 89.31 77 51.99

### **LIFE FITNESS ITALIA S.R.L.**

Via Vittorio Veneto, 57/A  
39042 Bressanone (Bolzano)  
ITALY  
Telephone: (+39) 0472.835 470  
FAX: (+39) 0472.833 150

### **LIFE FITNESS LATIN AMERICA and CARIBBEAN**

10601 West Belmont Avenue  
Franklin Park, Illinois 60131  
U.S.A.  
Telephone: (+1) 847.288.3300  
FAX: (+1) 847.288.3886

### **LIFE FITNESS UK LTD**

Queen Adelaide  
Ely, Cambs CB7 4UB  
UNITED KINGDOM  
Telephone: (+44) 1353.666017  
FAX: (+44) 1353.666018

### **LIFE FITNESS JAPAN**

Nippon Brunswick Bldg., #8F  
5-27-7 Sendagaya  
Shibuya-Ku, Tokyo  
JAPAN 151-0051  
Telephone: (+81) 3.3359.4309  
FAX: (+81) 3.3359.4307

M051-00K47-A033

06.03

Before using this product, it is essential to read this ENTIRE operation manual and ALL installation instructions.

This will help in setting up the equipment quickly and in instructing others on how to use it correctly and safely.

Avant toute utilisation de ce produit, il est indispensable de lire ce manuel d'utilisation dans son INTÉGRALITÉ, ainsi que TOUTES les instructions d'installations.

Ce manuel explique comment installer l'équipement et comment l'utiliser correctement et sans danger.

#### FCC Warning - Possible Radio / Television Interference

**NOTE:** *This equipment has been tested and found to comply with the limits for a Class A digital device, pursuant to part 15 of the FCC rules. These limits are designed to provide reasonable protection against harmful interference when the equipment is operated in a commercial environment. This equipment generates, uses and can radiate radio frequency energy, and if not installed and used in accordance with the operation manual, may cause harmful interference to radio communications. Operation of this equipment in a residential area is likely to cause harmful interference in which case the user will be required to correct the interference at his own expense.*

Class SB (Studio): Professional and / or commercial use.



**CAUTION: Any changes or modifications to this equipment could void the product warranty.**



**MISE EN GARDE: Tout changement et toute modification de ce matériel peut annuler la garantie du produit.**

Any service, other than cleaning or user maintenance, must be performed by an authorized service representative. There are no user-serviceable parts.

# TABLE OF CONTENTS

<b>Section</b>	<b>Description</b>	<b>Page</b>
1.	Getting Started	5
1.1	Important Safety Instructions	5
1.2	Set-up	7
	Where to Place the Life Fitness® Stairclimber // How to Stabilize the Stairclimber // How to Charge the Battery // Fitness Networking	
2.	The Display Console	10
2.1	The Display Console Overview	10
2.2	Display Console Descriptions	11
2.3	The Accessory Tray	14
3.	Heart Rate Zone Training Exercise	15
3.1	Why Heart Rate Zone Training Exercise?	15
3.2	Heart Rate Monitoring	16
	The Polar® Telemetry Heart Rate Monitoring Chest Strap	
4.	The Workouts	17
4.1	Workout Overviews	17
4.2	Using the Workouts	18
	To Begin any Workout // Selecting Quick Start // Selecting a Workout // Life Fitness Stairclimber Workout Setup Steps (chart) // Entering Weight // Entering Age // Entering Time // Selecting and Adjusting the Intensity Level // Switching Workouts “On-the-Fly” // Pausing Workouts // Ending Workouts Early	
4.3	Workout Descriptions	21
	Quick Start // Fat Burn // Cardio // Hill // Random // Manual // Heart Rate Hill™ Workout // Heart Rate Interval™ Workout // Extreme Heart Rate™ Workout // Watts // Mets // Six Pre-Set Workouts	
4.4	Using the Life Fitness Stairclimber	27
	Stairclimber Motion // Posture During Workouts // Braking Resistance	
5.	Optional Settings	28
5.1	Entering and Using the Optional Settings Feature	28
6.	Service and Technical Data	29
6.1	Preventative Maintenance Tips	29
6.2	Inspecting and Cleaning the Stairclimber	30
6.3	Troubleshooting the Polar Heart Rate Chest Strap	30
6.3	Heart Rate Reading is Erratic or Absent Entirely // Heart Rate Reading is Erratic or Extremely High	
6.4	How to Obtain Product Service	31
7.	Specifications	32
7.1	93S Stairclimber Specifications	32
7.2	90S Stairclimber Specifications	33fa

© 2003 Life Fitness, a division of Brunswick Corporation. All rights reserved. Life Fitness and Zone Training are registered trademarks of Brunswick Corporation. Zone Training+, Heart Rate Hill, Heart Rate Interval, and Extreme Heart Rate are trademarks of Brunswick Corporation. Polar is a registered trademark of Polar Electro, Inc. FitLinxx is a registered trademark of the Integrated Fitness Corp. Any use of these trademarks, without the express written consent of Life Fitness or the corresponding companies is forbidden.

This Operation Manual describes the functions of the following products:

Life Fitness stairclimber:

**93S, 90S**

See Section 7, titled *Specifications* page in this manual for product-specific features.

Statement of Purpose: The Life Fitness stairclimber is an exercise machine that simulates the movements of walking up stairs at various speeds.



**CAUTION: Life Fitness STRONGLY recommends seeing a physician for a complete medical exam before undertaking an exercise program, particularly if the user has a family history of high blood pressure or heart disease, is over the age of 45, smokes, has high cholesterol, is obese, or has not exercised regularly in the past year.**

If, at any time while exercising, the user experiences faintness, dizziness, pain, or shortness of breath, he or she must stop immediately.



**MISE EN GARDE: Life Fitness conseille VIVEMENT de consulter un médecin pour subir un examen médical complet avant de commencer tout programme d'exercice, et tout particulièrement si l'utilisateur a des antécédents familiaux d'hypertension ou de troubles cardiaques, ou s'il a plus de 45 ans, s'il fume, s'il a du cholestérol, s'il est obèse ou n'a pas fait d'exercice régulièrement depuis un an.**

Si, pendant l'utilisation de l'appareil, l'utilisateur ressent un malaise, des vertiges, des douleurs ou des difficultés à respirer, il doit cesser immédiatement.

# 1 GETTING STARTED

## 1.1 IMPORTANT SAFETY INSTRUCTIONS



**SAFETY WARNING:** The safety of the product can be maintained only if it is examined regularly for damage and wear. See Preventative Maintenance section for details.

- Use this appliance only for its intended use as described in this manual. Do not use attachments that have not been recommended by the manufacturer.
- If the Life Fitness stairclimber has been dropped, damaged, or partially immersed in water, contact Life Fitness Customer Support Services and do not use the unit.
- Be very careful not to allow other people to interfere in any way with the user or equipment while their exercise routine is in progress.
- Always follow the console instructions for proper operation.
- Close supervision is necessary when used near children, invalids or disabled persons.
- Do not use the Life Fitness stairclimber outdoors, near swimming pools, or in areas of high humidity.
- Never insert objects into any opening of the product. If an object should drop inside, carefully retrieve it while the unit is not in use. If the object cannot be reached, contact Life Fitness Customer Support Services.
- Never place liquids of any type directly on the unit, except in an accessory tray or holder. Containers with lids are recommended.
- Wear shoes with rubber or high-traction soles. Do not use shoes with heels, leather soles, cleats, or spikes. Make sure no stones are embedded in the soles.
- Do not use this product with bare feet.
- Keep all loose clothing, shoelaces, and towels away from moving parts.
- Do not reach into, or underneath, the unit or tip it on its side during operation.
- Keep the area around the Life Fitness stairclimber clear of any obstructions, including walls and furniture. Provide at least three feet of clearance behind the unit.
- Use caution when stepping on or off of the Life Fitness stairclimber.
- Never face backward while using the product.
- An American Society for Testing and Materials (ASTM) safety sign has been shipped with the Life Fitness stairclimber. Post the sign in a visible area near the unit.

**SAVE THESE INSTRUCTIONS FOR FUTURE REFERENCE.**

# 1 POINT DE DÉPART

## 1.1 CONSIGNES DE SÉCURITÉ IMPORTANTES



**CONSIGNE DE SÉCURITÉ : pour un emploi sûr, le produit doit être inspecté régulièrement afin de s'assurer qu'il n'est pas usé ni endommagé. Consultez la section de Maintenance préventive pour obtenir de plus amples informations.**

- Cet appareil ne doit être employé que pour l'usage auquel il est destiné, conformément aux directives de son manuel. N'utilisez pas d'accessoires qui ne seraient pas recommandés par le fabricant.
- Si le marchepied d'exercice Life Fitness a subi une chute, s'il a été endommagé ou s'il est tombé dans l'eau, contactez le service clientèle de Life Fitness et n'utilisez pas l'appareil.
- Assurez-vous que personne ne gêne l'utilisateur ou ne nuise au fonctionnement de l'appareil pendant qu'il fonctionne.
- Pour un fonctionnement correct, suivez toujours les instructions de la console.
- Une surveillance étroite est nécessaire en cas d'utilisation par des enfants, des personnes invalides ou handicapées.
- N'utilisez pas ce produit à l'extérieur, près d'une piscine ou dans des endroits très humides.
- N'insérez jamais d'objet dans les ouvertures de cet appareil. Si un objet tombe dedans, coupez l'alimentation électrique, débranchez le cordon de la prise et récupérez-le avec précaution. Si vous ne pouvez pas l'atteindre, consultez le service après-vente de Life Fitness.
- Ne placez jamais de liquides d'aucune sorte directement sur l'appareil, sauf si vous disposez d'un support ou d'un plateau pour accessoires. Il est recommandé d'utiliser des verres munis d'un couvercle.
- Portez des chaussures avec semelles en caoutchouc ou antidérapantes. N'utilisez pas de chaussures à talons, de semelles en cuir ou à crampons. Assurez-vous qu'aucun caillou ne s'est incrusté dans les semelles.
- N'utilisez pas cet appareil sans chaussures.
- Maintenez les vêtements lâches, les lacets et les serviettes à l'écart des pièces en mouvement.
- Ne placez pas les mains sous ou dans l'appareil, et ne le renversez pas sur le côté pendant le fonctionnement.
- Maintenez la zone autour du produit Life Fitness exempte d'obstructions, y compris de murs et de meubles. Veillez à laisser au moins 30 cm d'espace autour du Life Fitness stairclimber.
- Procédez avec précaution lors du montage ou du démontage du Life Fitness stairclimber.
- N'utilisez jamais cet appareil en vous tournant vers l'arrière.
- Un panneau de sécurité de l'American Society for Testing and Materials (ASTM) a été livré avec le marchepied d'exercice Life Fitness. Il doit être placé dans un endroit visible, proche de l'appareil.

**CONSERVEZ CES INSTRUCTIONS POUR USAGE ULTÉRIEUR.**

## 1.2 SETUP

Read the entire Operation Manual before setting up the Life Fitness stairclimber.

### WHERE TO PLACE THE LIFE FITNESS® STAIRCLIMBER

Following all safety instructions in Section 1.1, move the stairclimber to the location in which it will be used. See Section 7, titled *Specifications*, for the dimensions of the footprint. Allow a distance of 8 inches, or 21 centimeters, between the stairclimber and other units on either side. Allow a distance of 3 feet, or 1 meter, from the rear of the stairclimber to any object or surface.

### HOW TO STABILIZE THE STAIRCLIMBER

After placing the stairclimber in position, check the unit's stability by attempting to rock it in all directions. Any slight rocking indicates that the unit must be leveled. Determine which foot is not resting completely on the floor. Loosen the jam nut (B) with an open-end 9/16-inch wrench, and rotate the stabilizing foot (A) to lower it. Verify that the stairclimber is stable, and repeat the adjustment as necessary until the unit no longer rocks. Lock the adjustment by tightening the jam nut against the stabilizer bar.

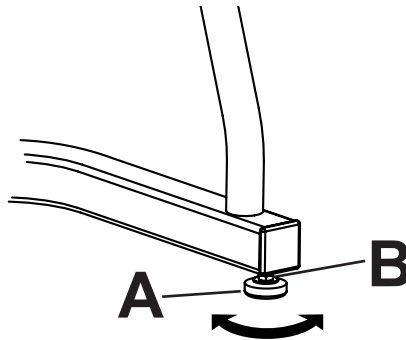



## HOW TO CHARGE THE BATTERY

The Life Fitness stairclimber is powered by a rechargeable 6V battery. Check the battery by pressing the START key or by stepping on the pedals. If the battery is charged, the console lights up, making it possible to program a workout. See section 4, titled *The Workouts*, for detailed information on programming workouts.

If the display console does not light up, the unit must be re-charged. To do so, use the optional plug-in charging unit. The charger should be connected to the stairclimber for a minimum of eight hours to ensure a thorough charge. The unit may be used while the battery is being charged.

Life Fitness recommends charging the unit overnight at least once per week to ensure a long life for the battery under the following conditions:

- The stairclimber is operated consistently by users who weigh less than 120 pounds
- Workout durations are consistently less than 20 minutes
- Usage is less than two hours per day

To recharge the stairclimber battery on domestic models, first plug the charger's (A) AC power cord into an electrical outlet. Then, plug the charging cable into the stairclimber jack, which is located at the front of the unit, near the floor.

To recharge the stairclimber battery on international models, first plug the AC power cord (C) into the charger (B). Next, plug the power cord into an electrical outlet. Then, plug the charging cable into the stairclimber jack, which is located at the front of the unit, near the floor.

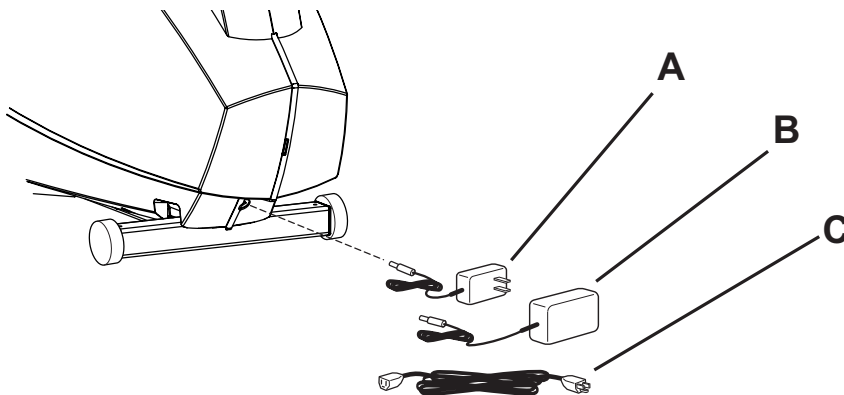

The plug must be inserted into an electrical outlet that has been properly installed and grounded in accordance with all local codes and ordinances.

*\*If the console display does not light up after the proper charging procedure is followed, call Customer Support Services.*

<b>Location</b>	<b>Voltage</b>	<b>Frequency Hz</b>	<b>Current AMPS</b>
United Kingdom	230	50	1
Federal Republic of Germany, France, Netherlands, Italy, Chile, Belgium, Korea, Argentina, Spain	230	50	1
Latin America	110/220	60	1
Japan	200	50/60	1
Australia	240+	50	1
U.S., Canada	120	60	1

## **FITNESS NETWORKING**

The Life Fitness stairclimber 93S model may be connected via CSAFE protocol to a network, such as the FitLinxx™ interactive fitness network. This service provides workout monitoring and customization through a link to a remote database. The user logs into the network at the console, and the database then uploads the user's personalized workout. When a workout is completed, the console uploads workout statistics to the database for progress tracking. See Section 4.2, titled *Using the Workouts*, for information on logging onto a network.

This service requires a special add-on kit to be installed with the stairclimber. In addition to providing the network connection, this kit enables the stairclimber to power third-party equipment for use with a service such as the Cardio Theater® entertainment system or the BroadcastVision™ entertainment system. Contact Life Fitness Customer Support Services to purchase the kit. See Section 6.4, titled *How to Obtain Product Service*. The network ports that connect the stairclimber to this service are located on the back of the stairclimber console and are enclosed by a removable cover. Any use of these ports for other than their intended purpose could void the product warranty.

# 2 THE DISPLAY CONSOLE

## 2.1 DISPLAY CONSOLE OVERVIEW

The computerized display console on the stairclimber allows the user to tailor a workout to personal fitness abilities and goals and to monitor progress. With this easy-to-use console the user can track fitness improvement from one workout to the next.

### The 93S console display

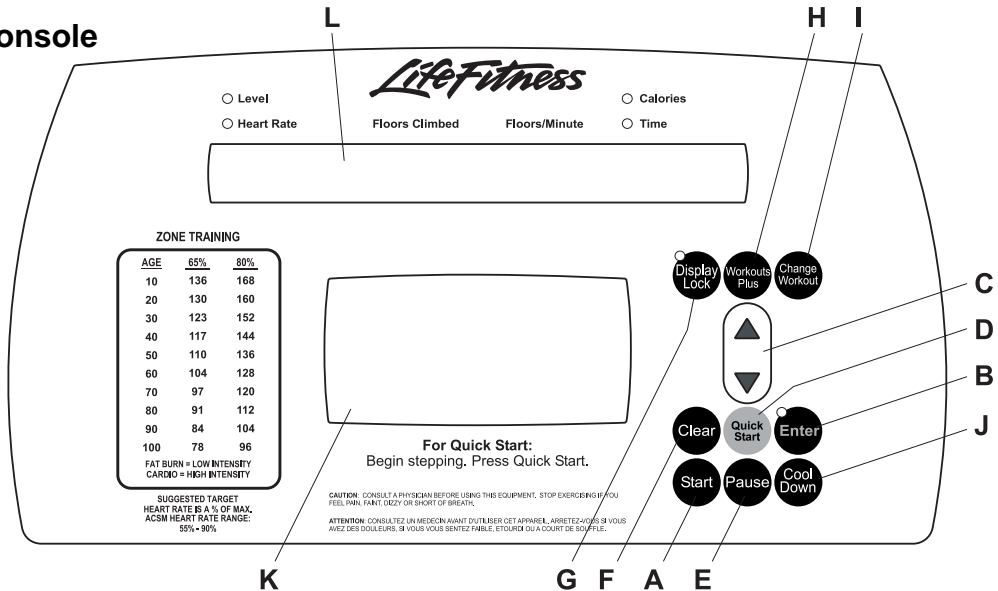

### The 90S console display

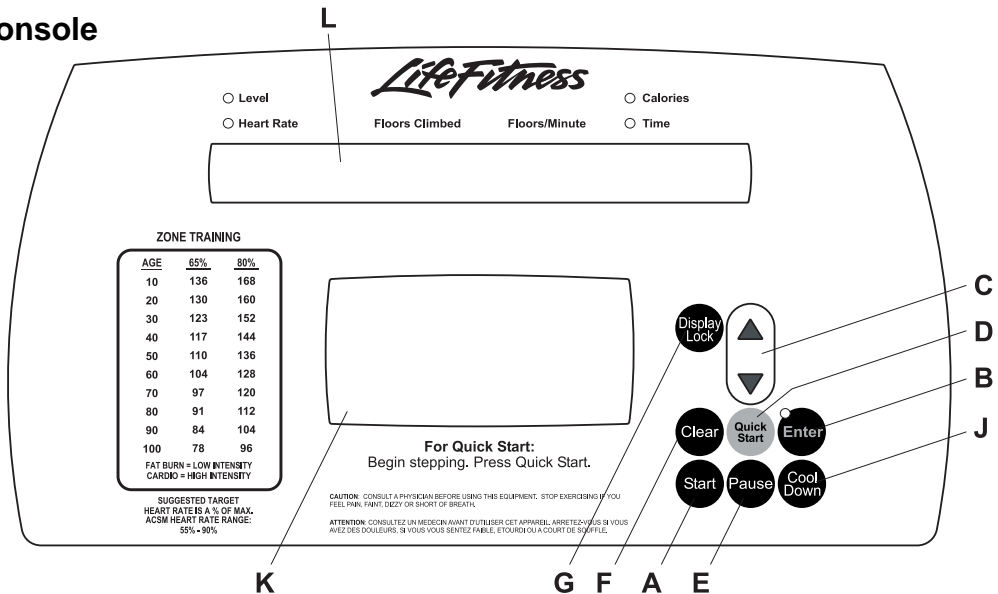

## 2.2 DISPLAY CONSOLE DESCRIPTIONS

The functions for the keys and display windows on the stairclimber console are listed and described in this section. See Section 4, titled *The Workouts*, for detailed information on using the console to set up workouts.

**A** **START:** Press this key to activate the console for programming a new workout. The activated console lights up and displays **SELECT WORKOUT USING ARROW KEYS OR PRESS QUICK START**. If no key is pressed, the console shuts down again.

**NOTE:** *The stairclimber's AutoStart feature activates the console when the user stands on the pedals and begins stepping.*

**B** **ENTER:** Press this key after entering each value, such as weight or workout time, when prompted by console display messages.

**C** **ARROW keys:** Use the **UP** and **DOWN ARROW** keys to change workout parameters displayed on the console, such as length of workout, weight, age, target heart rate, and intensity level. On the 93S model, pressing these keys during a **FAT BURN**, **CARDIO**, **HEART RATE HILL**, **HEART RATE INTERVAL**, or **EXTREME HEART RATE** workout increases or decreases the target heart rate.

**D** **QUICK START:** Press this key to begin a manual workout immediately, without having to select a workout. Once the workout is in progress, use the **ARROW KEYS** to change the intensity level or workout duration as desired.

**E** **PAUSE:** Press this key to pause a workout in progress. Press it again and resume climbing to continue the workout. The workout can be paused for a maximum duration of 60 seconds. During that time, it is possible to step off and back on without stopping the workout. However, after 60 seconds elapse, the console automatically shuts down.

**F** **CLEAR:** Press this key, when programming a workout, to clear incorrect data, such as weight or age, before pressing the **ENTER** key. Pressing **CLEAR** during a workout stops it immediately, at which point, the **MESSAGE CENTER** displays information about the workout, such as total time elapsed, total calories burned, and total floors climbed. Pressing **CLEAR** a second time causes the **MESSAGE CENTER** to prompt the user for a new workout setup.

**G** **DISPLAY LOCK:** During a workout, the **MESSAGE CENTER** alternately displays the number of **CALORIES** burned and the amount of **TIME** elapsed. Pressing the **DISPLAY LOCK** key when the **MESSAGE CENTER** displays either statistic, forces the **MESSAGE CENTER** to display that statistic continuously throughout the workout. Pressing **DISPLAY LOCK** again allows the **MESSAGE CENTER** to resume toggling between both statistics.

**H** **WORKOUTS PLUS** (93S only): Press this key to access additional workout options, such as various predetermined workout profiles and the ability to set goals based on different types of measurements. See Section 4, titled *The Workouts*, for details. The following workouts may be accessed with this key:

- **WATTS**
- **METS**
- **AROUND THE WORLD**
- **KILIMANJARO**
- **INTERVAL**
- **CASCADES**
- **SPEED TRAINING**
- **FOOT HILLS**

**I** **CHANGE WORKOUT** (93S only): Press this key to switch to another workout while a workout is in progress.

**J** **COOL DOWN**: Workouts end automatically in a Cool Down mode, which lowers the intensity level. Press the COOL DOWN key at any desired point during a workout to go immediately into Cool Down mode. In this phase of a workout the body begins to remove lactic acid and other accumulated by-products of exercise, which build up in muscles during a workout and contribute to muscle soreness. The console automatically adjusts each workout's Cool Down level according to the individual user's performance. Each time the user presses the COOL DOWN key, the Cool Down duration shortens by one minute.

**K** **WORKOUT PROFILE WINDOW**: This window displays shapes, made of columns of lights, that represent the levels of intensity in a workout-in-progress. The height of the column is proportional to the level of the intensity.

During a **FAT BURN** (available on 93S; also available on 90S if telemetry option is installed), **CARDIO** (available on 93S; also available on 90S if telemetry option is installed), **HEART RATE HILL** (93S only), **HEART RATE INTERVAL** (93S only), or **EXTREME HEART RATE** (93S only) workout, which requires the use of the a Polar heart rate chest strap, the WORKOUT PROFILE window displays a heart shape to request the user's heart rate signal. If the console does not detect a signal, the MESSAGE CENTER displays the prompt, "NEED HEART RATE - USE TELEMETRY STRAP". If the console does not receive the signal within three minutes, the workout automatically is converted to a **MANUAL** workout. Profiles are not available for **FAT BURN**, **CARDIO**, **HEART RATE HILL**, **HEART RATE INTERVAL**, or **EXTREME HEART RATE**. In these workouts, the level is based on the heart rate. Therefore, the profile cannot be displayed.

**L MESSAGE CENTER:** This window displays step-by-step instructions for setting up a workout. When a workout is in progress, it displays statistics about the progress of the workout, as seen below:

- **Time:** time elapsed since the start of the workout.
- **Level:** programmed intensity level.
- **Floors/Minute:** rate of floors climbed per minute.
- **Calories:** number of calories burned since beginning the workout; based on a calculation involving the entered weight of the user and the step rate. If the user does not enter weight during the workout setup, the computer does not make this calculation.
- **Heart Rate:** detected heart rate if the user is wearing the chest strap.
- **Floors Climbed:** number of floors climbed since the start of the workout, based on a calculation involving the step rate.

The MESSAGE CENTER also can be programmed to display any of the following three values each time the intensity level changes during the workout. See Section 5, titled *Optional Settings*, for more information.

- **Calories per Hour:** rate of calories burned per hour.
- **Watts:** effort level in Watts. The Watt is a unit of power output or the expression of the mechanical rate of work.
- **Mets:** effort level in Mets. The Met is an expression of the rate of work for the human body, or a metabolic equivalent; one Met is approximately equal to the metabolism of a person at rest.

**Note:** *The Watts display and the Calories Per Hour display cannot be turned on at the same time.*

## 2.3 THE ACCESSORY TRAY

The accessory tray (A), which is mounted to the base of the console, provides dual storage trays with space for items such as water bottles, personal stereos, and cell phones. Additionally, an integrated reading rack (B) for supporting a book or magazine is located at the base of the upper panel of the console. The tray is standard on the 93S model and optional on the 90S model. To order it, call Life Fitness Customer Support Services. See Section 6.4, titled *How to Obtain Product Service*.

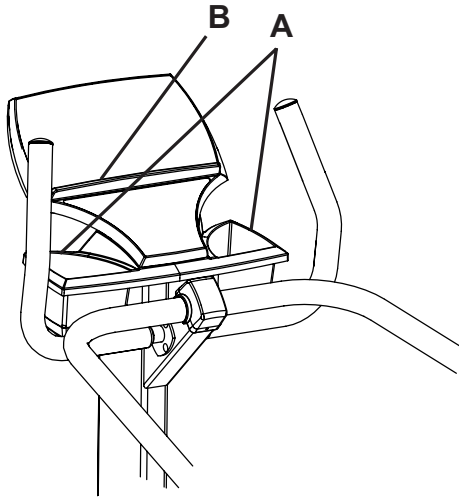

# 3 HEART RATE ZONE TRAINING EXERCISE

## 3.1 WHY HEART RATE ZONE TRAINING EXERCISE?

Research shows that maintaining a specific heart rate while exercising is the optimal way to monitor the intensity of a workout and to achieve maximum results. That is the idea behind the Life Fitness heart rate zone training approach to exercise.

Zone training identifies an exerciser's ideal heart rate range, or zone, for burning fat or increasing cardiovascular fitness. The values within the zone depend on the workout.

**NOTE:** Consulting a fitness trainer is recommended for defining specific fitness goals and designing a workout program.

ZONE TRAINING		
FAT BURN = LOW INTENSITY		
CARDIO = HIGH INTENSITY		
AGE	65%	80%
10	136	168
20	130	160
30	123	152
40	117	144
50	110	136
60	104	128
70	97	120
80	91	112
90	84	104
100	78	96

SUGGESTED TARGET  
HEART RATE AS % OF MAX  
ACSM HEART RATE RANGE:  
55% - 90%

The stairclimber features exclusive workouts designed to take full advantage of the benefits of heart rate zone training exercise. **FAT BURN**, **CARDIO**, **HEART RATE HILL**, **HEART RATE INTERVAL**, and **EXTREME HEART RATE** are available on the 93S. **FAT BURN** and **CARDIO** are available on the 90S when the optional telemetry feature is installed. For detailed information about these workouts, see Section 4, titled *The Workouts*.

During one of these workouts wear the optional telemetry chest strap to enable the stairclimber's on-board computer to monitor the heart rate. The computer automatically adjusts the resistance level to maintain the target heart rate\* based on the actual heart rate. To change the target heart rate during a workout, use the ARROW keys.

\* Target Heart Rate (THR) is a percentage of the theoretical maximum. For example, a 40-year-old user's THR for the **CARDIO** workout is 144. This workout targets 80 percent of the maximum, so the equation would be  $(220-40) \cdot 80 = 144$ . A 20-year-old user's THR is 160, so the equation would be  $(220-20) \cdot 80 = 160$ .



## 3.2 HEART RATE MONITORING

### THE POLAR® TELEMETRY HEART RATE MONITORING CHEST STRAP

The Life Fitness stairclimber is equipped with Polar telemetry (optional on the 90S model), a heart rate monitoring system in which electrodes, pressed against the skin, transfer heart rate signals to the stairclimber console. These electrodes are attached to a chest strap that the user wears during the workout. To order the optional telemetry feature for the 90S, or the Polar heart rate chest strap for either model, call Life Fitness Customer Support Services. See Section 6.4, titled *How to Obtain Product Service*.

See the diagram below for correct positioning of the strap. The electrodes (A), which are the two grooved surfaces on the underside of the strap, must remain wet to transmit accurately the electrical impulses of the heart back to the receiver. Moisten the electrodes. Then, secure the strap as high under the chest muscles as possible. The strap should be snug, but comfortable enough to allow for normal breathing.

The transmitter strap delivers an optimal heart rate reading when the electrodes are in direct contact with skin. However, it also functions properly through a thin layer of wet clothing.

If it becomes necessary to re-moisten the chest strap electrodes, grasp the center of the strap, pull it away from the chest to expose the two electrodes, and moisten them.

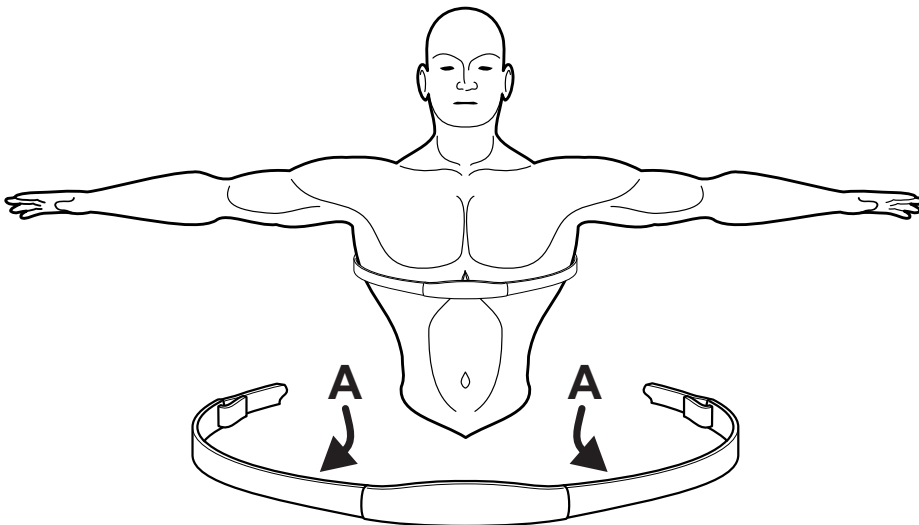

# 4 THE WORKOUTS

## 4.1 WORKOUT OVERVIEWS

This section lists the Life Fitness stairclimber pre-programmed workouts. For more detailed information, see Section 4.2, titled *Using the Workouts*.

**QUICK START** is the fastest way to begin exercising, and it bypasses the steps involved in selecting a specific workout. Once **QUICK START** is selected, a constant-level workout begins. The intensity level does not change automatically.

**FAT BURN** (available on 93S; also available on 90S if telemetry option is installed) is a lower-intensity workout for burning the body's fat reserves. The user must wear a heart rate chest strap. The workout automatically adjusts the intensity level, based on the actual heart rate, to maintain the rate at 65 percent of the theoretical maximum.<sup>†</sup>

**CARDIO** (available on 93S; also available on 90S if telemetry option is installed) is a higher intensity workout for more fit users, emphasizing cardiovascular benefits and maximum fat burning. The user must wear a heart rate chest strap. The workout automatically adjusts the intensity level, based on the actual heart rate, to maintain the rate at 80 percent of the theoretical maximum.

**HILL** is an interval-training workout combining "hills" and "valleys" of different intensity levels, which is proven to provide effective, time-efficient cardiovascular results.

**RANDOM** is an interval training workout of constantly changing intensity levels that occur in no regular pattern or progression to challenge the user.

**MANUAL** is a workout in which the intensity level does not change automatically.

**HEART RATE HILL** (93S only) takes the user through three different hills based on the target heart rate\*. The user wears a heart rate chest strap, or grasps the Lifepulse™ sensors continuously.

**HEART RATE INTERVAL** (93S only) alternates between a hill and a valley based on the target heart rate\*. The user wears a heart rate chest strap, or grasps the Lifepulse™ sensors continuously.

**EXTREME HEART RATE** (93S only) is an intense workout for more experienced users. It is designed to get the heart rate up and down as quickly as possible. The user wears a heart rate chest strap, or grasps the Lifepulse™ sensors continuously.

The following workouts, available on the 93S model, are accessed by pressing the

WORKOUTS PLUS key :

**WATTS** targets a rate of effort equal to a certain number of Watts. A Watt is a unit of power that measures the amount of mechanical work required to operate a device, such as a stairclimber. It is roughly equal to .25 calories per hour.

<sup>†</sup> Defined by the American College of Sports Medicine's "Guidelines for Exercise Testing and Prescription" as equal to 220 minus an individual's age.

\* Target Heart Rate (THR) is a percentage of the theoretical maximum. For example, a 40-year-old user's THR for the **HEART RATE HILL** workout is 144. This workout targets 80 percent of the maximum, so the equation would be  $(220-40) \cdot .80 = 144$ . A 20-year-old user's THR is 160, so the equation would be  $(220-20) \cdot .80 = 160$ .

**METS** targets a rate of effort equal to a certain number of Mets. A Met is a unit of measurement used to express the metabolic rate of work (oxygen consumption per unit of body weight) required to perform a task. One Met is approximately equal to a person's metabolism when seated and relaxed.

**AROUND THE WORLD** is an interval-training workout in which the hills resemble scenes of various geographical areas.

**KILIMANJARO** is a Hill workout in which the intensity levels gradually incline toward one ultimate peak and then gradually decline.

**INTERVAL** is a Hill workout in which intensity levels rise and fall. The higher levels gradually incline toward a peak and then gradually decline.

**CASCADES** is a two-peak workout in which intensity levels gradually incline and decline.

**SPEED TRAINING** is a Hill workout in which the intensity level alternates between high and low levels very quickly to simulate a typical speed training workout.

**FOOT HILLS** is a rolling hill workout with low intensity levels.

## 4.2 USING THE WORKOUTS

Different stairclimber workouts require different setup steps. See the chart on the following page, titled *Life Fitness Stairclimber Workout Set-up Steps*, for a quick glance at the steps for setting up any individual workout. This section provides details on the steps themselves.

**Note:** *A new Life Fitness stairclimber may emit a slight smell during the first few hours of operation as the load resistor heats up for the first time. If the smell persists, contact customer service.*

### TO BEGIN ANY WORKOUT

**With optional networking kit installed** (93S only), press START or simply step on the pedals to activate the console. The MESSAGE CENTER displays the prompt: "SELECT WORKOUT USING ARROW KEYS OR ENTER ID USING ENTER KEY". Either select a workout as described below, or log on to the networked exercise database, and then select a workout. To log onto the network, use the ARROW KEYS to scroll in the user ID number.

**Without networking**, press START or simply step on the pedals to activate the console. The MESSAGE CENTER displays the prompt: "SELECT WORKOUT USING ARROW KEYS OR PRESS QUICK START". If it displays a different message, press the CLEAR key twice rapidly.

### SELECTING QUICK START

**QUICK START** is the fastest way to begin exercising, and it bypasses the steps of selecting a specific workout. At the MESSAGE CENTER prompt, press the QUICK START key. The workout begins at an intensity level that remains the same unless manually changed.

### SELECTING A WORKOUT

For **MANUAL**, **FAT BURN** (available on 93S; also available on 90S if telemetry option is installed), **CARDIO** (available on 93S; also available on 90S if telemetry option is installed), **RANDOM**, **HILL**, **HEART RATE HILL** (93S only), **HEART RATE INTERVAL** (93S only), and **EXTREME HEART RATE** (93S only): When prompted to select a workout, use the ARROW KEYS to scroll through the workout names as they appear in the MESSAGE CENTER. When the desired workout appears, press ENTER.

For **COAST TO COAST**, **KILIMANJARO**, **INTERVAL**, **CASCADES**, **SPEED TRAINING**, and **FOOT HILLS**: All of these workouts are available on the 93S model only. When prompted by the MESSAGE CENTER to select a workout, press the WORKOUTS PLUS key. The MESSAGE CENTER then displays the name of one of these workouts. Press ENTER to select the displayed workout; or continue to press the WORKOUTS PLUS key to display each of the other options, and then press ENTER to select the desired workout.

## LIFE FITNESS STAIRCLIMBER WORKOUT SETUP STEPS

### QUICK START

Select QUICK START  
Enter weight  
Begin workout

### HILL

Select HILL  
Enter weight  
Enter time  
Select intensity level  
Begin workout

### RANDOM

Select RANDOM  
Enter weight  
Enter time  
Enter intensity level  
Begin workout

### MANUAL

Select MANUAL  
Enter weight  
Enter time  
Enter intensity level  
Begin workout

### FAT BURN (available on 93S; also available on 90S if telemetry option is installed)\*

Select FAT BURN  
Enter weight  
Enter time  
Enter age  
Accept THR\*\*  
Begin workout

### CARDIO (available on 93S; also available on 90S if telemetry option is installed)\*

Select CARDIO  
Enter weight  
Enter time  
Enter age  
Accept THR\*\*  
Begin workout

### HEART RATE HILL\* (93S only)

Select HEART RATE  
HILL  
Enter weight  
Enter time  
Enter age  
Accept THR\*\*  
Begin workout

### HEART RATE INTERVAL\* (93S only)

Select HEART RATE  
INTERVAL  
Enter weight  
Enter time  
Enter age  
Accept THR\*\*  
Begin workout

### EXTREME HEART RATE\* (93S only)

Select EXTREME  
HEART RATE  
Enter weight  
Enter time  
Enter age  
Accept THR\*\*  
Begin workout

### WATTS (if enabled)

Press WORKOUTS  
PLUS repeatedly until  
WATTS appears;  
press ENTER  
Enter weight  
Enter time  
Enter Watts goal value  
Begin workout

### METS (if enabled)

Press WORKOUTS  
PLUS repeatedly until  
WATTS appears;  
press ENTER  
Enter weight  
Enter time  
Enter Mets goal value  
Begin workout

### AROUND THE WORLD (93S only)

Press WORKOUTS  
PLUS repeatedly until  
COAST TO COAST  
appears; press  
ENTER  
Enter weight  
Enter time  
Select intensity level  
Begin workout

### KILIMANJARO (93S only)

Press WORKOUTS  
PLUS repeatedly until  
KILIMANJARO  
appears; press  
ENTER  
Enter weight  
Enter time  
Select intensity level  
Begin workout

### INTERVAL (93S only)

Press WORKOUTS  
PLUS repeatedly until  
INTERVAL appears;  
press ENTER  
Enter weight  
Enter time  
Select intensity level  
Begin workout

### CASCADES (93S only)

Press WORKOUTS  
PLUS repeatedly until  
CASCADES appears;  
press ENTER  
Enter weight  
Enter time  
Select intensity level  
Begin workout

### SPEED TRAINING (93S only)

Press WORKOUTS  
PLUS repeatedly until  
SPEED TRAINING  
appears; press  
ENTER  
Enter weight  
Enter time  
Select intensity level  
Begin workout

### FOOT HILLS (93S only)

Press WORKOUTS  
PLUS repeatedly until  
FOOT HILLS  
appears; press  
ENTER  
Enter weight  
Enter time  
Select intensity level  
Begin workout

\* This workout requires the user to wear the Polar heart rate chest strap.

\*\* Target Heart Rate (THR) is a percentage of the theoretical maximum. For example, a 40-year-old user's THR for the **CARDIO** workout is 144. This workout targets 80 percent of the maximum, so the equation would be  $(220-40) \cdot 80 = 144$ . A 20-year-old user's THR is 160, so the equation would be  $(220-20) \cdot 80 = 160$ . A 20-year-old user's THR is 160, so the equation would be  $(220-20) \cdot 80 = 160$ .

## ENTERING WEIGHT

When prompted by the MESSAGE CENTER to enter weight, use the ARROW KEYS to increase or decrease the displayed weight to the correct value, and press ENTER. Stairclimber workouts calculate the number of calories burned based on the user's weight and step rate.

## ENTERING AGE

When prompted by the MESSAGE CENTER to enter age, use the ARROW KEYS to increase or decrease the displayed age to the correct value, and press ENTER. Stairclimber workouts that set a target heart rate\* zone first calculate the user's theoretical maximum heart rate† by subtracting the user's age from the number 220. The workouts then calculate the target zone as a percentage of the theoretical maximum.

## ENTERING TIME

When prompted by the MESSAGE CENTER to enter a time, use the ARROW KEYS to increase or decrease the displayed time to the desired value, and press ENTER.

## SELECTING AND ADJUSTING THE INTENSITY LEVEL

When prompted by the MESSAGE CENTER, use the ARROW KEYS to increase or decrease the displayed intensity level or target heart rate\* to the desired value, and press ENTER. Adjust the level as needed or desired during the workout.

- Intensity level: The Life Fitness stairclimber provides a selection of 20 intensity levels. The step speed for Level 1, the easiest setting, is two floors per minute; the tiers of difficulty increase up to Level 20, with a step rate of 13 floors per minute. The intensity level appears in the WORKOUT PROFILE window as columns of light. Selecting a low intensity level at first is recommended. As physical conditioning improves, the levels can increase.
- Target heart rate: Stairclimber workouts that calculate a target heart rate base this number on the age of the user and the type of workout. The user accepts or adjusts the rate when setting up the workout. During the workout itself, the workout reads the heart rate, which is transmitted via the chest strap; and it uses this data to adjust the resistance. Manually raising the rate increases the intensity of the cardiovascular exercise.

## SWITCHING WORKOUTS “ON-THE-FLY” (93S ONLY)

It is possible, during a workout, to switch to another workout. After a switch, the console retains all the progress information about the workout since its beginning. To change workouts “on the fly,” press the CHANGE WORKOUT key. Then, using the ARROW KEYS, scroll through the workout options displayed by the MESSAGE CENTER. When the desired workout appears, press ENTER.

## PAUSING WORKOUTS

To pause a workout in progress, press the PAUSE key, or simply stop climbing. Press the PAUSE key again, and resume climbing to continue the workout. The workout can be paused for a duration of 60 seconds. During that time, it is possible to step off and back on without stopping the workout. If the workout is not resumed in 60 seconds, the console automatically shuts down.

<sup>†</sup> Defined by the American College of Sports Medicine's "Guidelines for Exercise Testing and Prescription" as equal to 220 minus an individual's age.

\* Target Heart Rate (THR) is a percentage of the theoretical maximum. For example, a 40-year-old user's THR for the **CARDIO** workout is 144. This workout targets 80 percent of the maximum, so the equation would be  $(220-40) \times .80 = 144$ . A 20-year-old user's THR is 160, so the equation would be  $(220-20) \times .80 = 160$ .

## ENDING WORKOUTS EARLY

To end a workout before the pre-set duration expires, press CLEAR once. The MESSAGE CENTER then displays a workout summary, which includes the number of floors climbed, the total calories burned and other statistics. Press CLEAR a second time, and the MESSAGE CENTER displays "SELECT WORKOUT USING ARROW KEYS OR PRESS QUICK START" for a new workout.

## 4.3 WORKOUT DESCRIPTIONS

### QUICK START

**QUICK START** is the fastest way to begin exercising, and it bypasses the steps of selecting a specific workout. The intensity level for the workout is set automatically and remains the same unless manually changed. To change the level press the UP or DOWN ARROW keys. If the CALORIES PER HOUR display is enabled, the MESSAGE CENTER displays "ENTER WEIGHT", which is required to calculate this ratio. Using the ARROW KEYS, increase or decrease the displayed weight to the correct value.

### FAT BURN

**(AVAILABLE ON 93S; ALSO AVAILABLE ON 90S IF TELEMETRY OPTION IS INSTALLED)**

The **FAT BURN** workout is designed to maintain a user's heart rate at 65 percent of the theoretical maximum rate<sup>†</sup> for optimal results. Throughout the workout, the user wears a chest strap. The console continuously monitors and displays the heart rate, adjusting the intensity level of the Life Fitness stairclimber to reach and maintain the target\*. This system eliminates over- and under-training, and it maximizes the aerobic benefits of exercise by using the body's fat stores for fuel.

### CARDIO

**(AVAILABLE ON 93S; ALSO AVAILABLE ON 90S IF TELEMETRY OPTION IS INSTALLED)**

The **CARDIO** workout is virtually identical to **FAT BURN**; however the target heart rate is calculated at 80 percent of the theoretical maximum. The higher target promotes cardiovascular improvement by placing a heavier workload on the heart muscle. The user wears a chest strap.

### HILL

The Life Fitness-patented **HILL** workout offers a variety of configurations for interval training. Intervals are periods of intense aerobic exercise separated by regular periods of lower-intensity exercise. The WORKOUT PROFILE window represents these high and low intervals as columns of light, which together have the appearance of hills and valleys. The computerized interval training workout has been scientifically demonstrated to promote greater cardio-respiratory improvement than steady-pace training.

Each **HILL** workout goes through four phases, each marked by different intensity levels. The WORKOUT PROFILE window displays the progress of these phases, as seen in the chart following these descriptions below. The heart rate should be measured at two stages in the workout to gauge

<sup>†</sup> Defined by the American College of Sports Medicine's "Guidelines for Exercise Testing and Prescription" as equal to 220 minus an individual's age.

\* Target Heart Rate (THR) is a percentage of the theoretical maximum. For example, a 40-year-old user's THR for the **FAT BURN** workout is 117. This workout targets 65 percent of the maximum, so the equation would be  $(220-40) \times .65 = 117$ . A 20-year-old user's THR is 130, so the equation would be  $(220-20) \times .65 = 130$ .

its effectiveness. To do so, wear the chest strap. Note that the MESSAGE CENTER does not display a request for a heart rate measurement during a **HILL** workout.

- 1 **Warm-up** is a phase of low, gradually rising resistance, which brings the heart rate into the lower end of the target zone\* and increases respiration and blood flow to working muscles.
- 2 **Plateau** increases the intensity slightly, and keeps it steady, to bring the heart rate to the low end of the target zone. Check the heart rate at the end of this phase.
- 3 **Interval Training** is a series of increasingly steeper hills alternating with valleys, or stints of recovery. The heart rate should rise to the high end of the target zone. Check the heart rate at the end of this phase.
- 4 **Cool-down** is a low-intensity phase that allows the body to begin removing lactic acid and other exercise by-products, which build up in muscles and contribute to soreness.

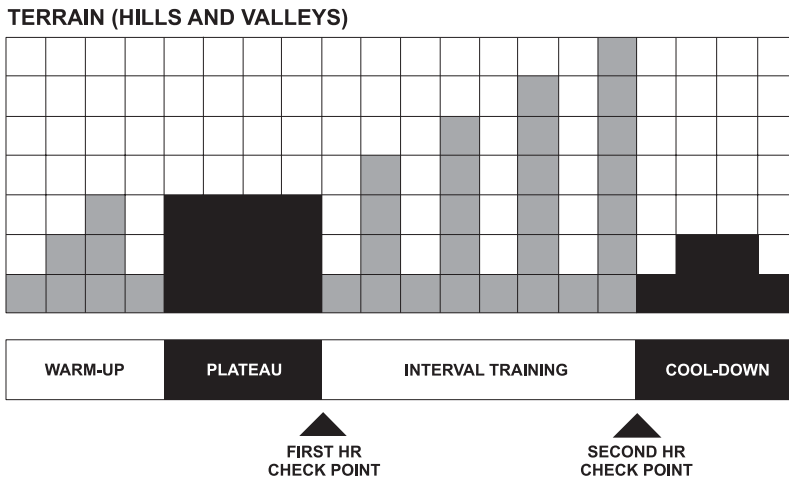

Each column, as seen in the WORKOUT PROFILE WINDOW and the chart above, represents one interval. The overall duration of the workout determines the length of each interval. Each workout is made up of 20 intervals, so the duration of each interval is equal to the duration of the entire workout divided by 20.

**10 to 19 minutes:** The interval durations initially are set at 30 seconds for a six-minute workout. For every minute added by the user “on the fly,” each interval increases by three seconds. A 15-minute workout consists of 20 intervals at 45 seconds each.

**20 to 99 minutes:** All intervals last 60 seconds. If the user adds minutes to the pre-set duration while the workout is in progress, the workout adds hills and valleys that are identical to the first eight intervals of the Interval Training phase. This pattern repeats until the workout is completed.

## RANDOM

The **RANDOM** workout creates a terrain of hills and valleys that varies with each workout. More than one million different patterns are possible.

## MANUAL

The **MANUAL** workout sets an intensity level that does not change automatically. While the workout is in progress, increase or lower the intensity level as desired, using the arrow keys.

## HEART RATE HILL™ WORKOUT (93S ONLY)

This program combines the standard HILL workout profile with the concept of Heart Rate Zone Training. The default target heart rate\* is calculated as 80 percent of the theoretical maximum† (HRmax), but the user can adjust the target rate during the workout setup. All hills and valleys are percentages of HRmax. The workout consists of three hills that target three heart rate goals: The first hill brings the heart rate to 70 percent of HRmax. The second hill increases the rate to 75 percent of HRmax. The third hill matches the Target Heart Rate bringing the heart rate to 80 percent of HRmax. The valley always is defined as 65 percent of HRmax.

After a standard three-minute warm-up, the workout progresses toward the first hill and heart rate goal. Once the user reaches 70 percent of HRmax, the hill continues for one minute. When the minute expires, the level decreases into a valley. Once the user's heart rate falls to 65 percent of HRmax, the valley continues for one minute. Then, the next hill begins with its corresponding heart rate goal. After the user completes the third hill/valley pair, the program returns to the first hill and repeats the cycle as long as the duration allows. At the end of the duration, the workout goes into a cool-down phase. If the heart rate goes above the theoretical maximum for more than 45 seconds, the stairclimber automatically goes into pause mode. The program does not proceed to a new heart rate goal until the user reaches the current goal.

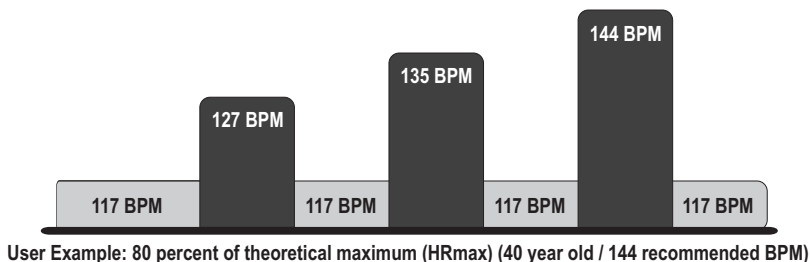
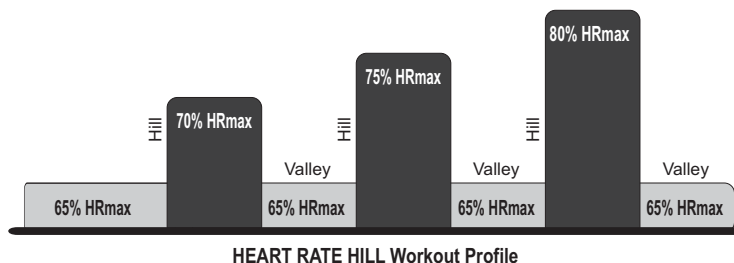

Defined by the American College of Sports Medicine's "Guidelines for Exercise Testing and Prescription" as equal to 220 minus an individual's age.

\* Target Heart Rate (THR) is a percentage of the theoretical maximum (HRmax). A 40-year-old user's recommended THR for the HEART RATE HILL workout is 144, or 80 percent of the maximum; so the equation would be  $(220-40) \cdot 80 = 144$ .



## HEART RATE INTERVAL™ WORKOUT (93S ONLY)

This program also combines the standard **HILL** workout profile with the concept of Heart Rate Zone Training. The default target heart rate\* is calculated as 80 percent of the theoretical maximum† (HRmax), but the user can adjust the target rate during the workout setup. The workout alternates between a hill, which brings the heart rate up to the target rate of 80 percent of HRmax, and a valley, which brings the heart rate down to 65 percent of HRmax. After a standard three-minute warm-up, the workout progresses toward the first hill and heart rate goal. Once the goal is reached, the hill continues for three minutes. Then the level decreases into a valley. Once the 65 percent of HRmax goal is reached, the valley continues for three minutes, after which the next hill begins. The user's fitness level determines the number of hills and valleys encountered within the duration. At the end of the duration, the workout goes into a cool-down phase. If the heart rate goes above the theoretical maximum† for more than 45 seconds, the stairclimber automatically goes into pause mode. The program does not proceed to a new heart rate goal until the user reaches the current goal.

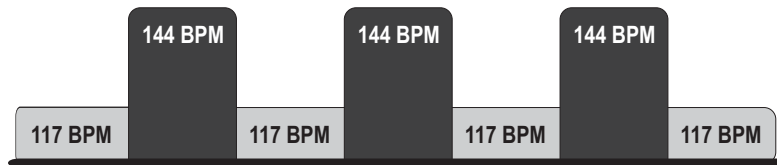
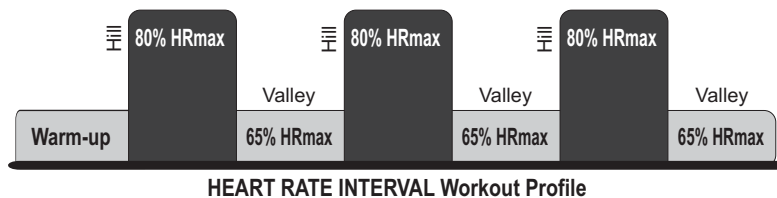

User Example: 80 percent of theoretical maximum (HRmax) (40 year old / 144 recommended BPM)

† Defined by the American College of Sports Medicine's "Guidelines for Exercise Testing and Prescription" as equal to 220 minus an individual's age.

\* Target Heart Rate (THR) is a percentage of the theoretical maximum (HRmax). A 40-year-old user's recommended THR for the HEART RATE INTERVAL workout is 144, or 80 percent of the maximum; so the equation would be  $(220-40) \cdot 80 = 144$ .

## EXTREME HEART RATE™ WORKOUT (93S ONLY)

This intense, varied workout is designed to help more experienced users to break through fitness improvement plateaus. The workout alternates between two target heart rates\* as quickly as possible. The effect is similar to that of running sprints. The user must wear a chest strap or grip the Lifepulse™ sensors throughout the workout.

When setting up the workout, the user enters a target heart rate. After a standard three-minute warm-up, the intensity increases, until the user reaches the target heart rate goal of 85 percent of the theoretical maximum† (HRmax). That target rate is maintained for a stabilizing period. Then the intensity decreases. When the heart rate falls to the 65 percent of HRmax goal, it is maintained there for a stabilizing period. The program repeats the alternating of intensity levels, continuing this pattern throughout the duration.

The program does not proceed to a new heart rate goal until the user reaches the current goal.

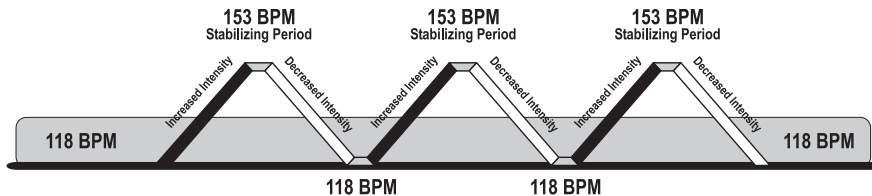
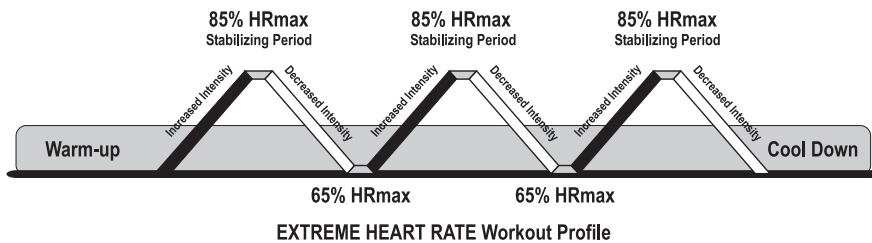

User Example 85 percent of theoretical maximum (HRmax) (40 year old / 153 recommended BPM)

† Defined by the American College of Sports Medicine's "Guidelines for Exercise Testing and Prescription" as equal to 220 minus an individual's age.

\* Target Heart Rate (THR) is a percentage of the theoretical maximum (HRmax). For example, a 40-year-old user's recommended THR for the EXTREME HEART RATE™ WORKOUT is 153. The workout program targets a standard 85 percent of the maximum, so the equation would be  $(220-40) \cdot 85 = 153$ .

## **WATTS (WHEN ENABLED)**

This workout targets a rate of effort equal to a certain number of Watts. A Watt is a unit of power that measures the amount of mechanical work required to operate a device, such as a stair-climber. It is roughly equal to 0.25 calories per hour. The workout automatically alters the intensity level to maintain the appropriate rate of effort. For information on enabling this workout, see Section 5, titled *Optional Settings*.

## **METS (WHEN ENABLED)**

This workout targets a rate of effort equal to a certain number of Mets. A Met is a unit of measurement used to express the metabolic rate of work (oxygen consumption per unit of body weight) required to perform a task. The workout automatically alters the intensity level to maintain the appropriate rate of effort. For information on enabling this workout, see Section 5, titled *Optional Settings*.

## **SIX PRE-SET WORKOUTS (93S ONLY)**

**AROUND THE WORLD, KILIMANJARO, INTERVAL, CASCADES, SPEED TRAINING,** and **FOOT HILLS** are variations of the **HILL** workout. These workouts cannot be changed "on the fly."

**AROUND THE WORLD** is an interval-training workout in which the hills resemble scenes of various geographical areas.

**KILIMANJARO** is a Hill workout in which the intensity levels gradually incline toward one ultimate peak and then gradually decline.

**INTERVAL** is a Hill workout in which intensity levels rise and fall. The higher levels gradually incline toward a peak and then gradually decline.

**CASCADES** is a two-peak workout in which intensity levels gradually incline and decline.

**SPEED TRAINING** is a Hill workout in which the intensity level alternates between high and low levels very quickly to simulate a typical speed training workout.

**FOOT HILLS** is a rolling hill workout with low intensity levels.

## **4.4 USING THE LIFE FITNESS STAIRCLIMBER**

### **STAIRCLIMBER MOTION**

The Life Fitness stairclimber permits a maximum stepping height of 13.5 inches, or 34.3 centimeters. The unit features independent stepping action, which means that the pedals move independently of each other. Benefits of this feature include:

- Pull-push hip and knee action, which simulates actual stair climbing
- Development of greater muscular strength and endurance
- Optimal muscular development for the right leg and left leg individually
- Better cardiovascular exercise

### **POSTURE DURING WORKOUTS**

Begin stepping at a comfortable pace, taking either full or short steps, and keeping the back straight. Hold the handrails, or the bullhorns on the 93S, for stability and balance only. It should be noted that using the handrails for support can offload weight and cause the Life Fitness stairclimber console to give inaccurate readings of calories burned.

### **BRAKING RESISTANCE**

The Life Fitness stairclimber features speed-dependent braking resistance. During a workout, the computer monitors the user's step rate and maintains it at the rate that corresponds to the selected intensity level. If the user's speed exceeds the corresponding rate, the computer increases the resistance to lower the user's speed. If the user's step rate is slower, the computer decreases the resistance to enable the user to increase speed.

# 5 OPTIONAL SETTINGS

## 5.1 ENTERING AND USING THE OPTIONAL SETTINGS FEATURE

Fitness club managers and other authorized personnel can use the Optional Settings feature to change default settings, or to enable or disable certain programs or displays on the console.

To enter the Optional Settings, while the unit is on, hold down the UP ARROW key, and press CLEAR twice. The MESSAGE CENTER displays a program version number. Press the ENTER key. The MESSAGE CENTER displays "OPTIONAL SETTINGS". Scroll forward through the options using the ENTER key, or backward, using the CLEAR key. For each feature or setting option, the MESSAGE CENTER displays the default setting. To change the default, press the UP or DOWN ARROW key for the desired value. Press ENTER to select the new value or setting and proceed to the next setting.

To exit Optional Settings, press the CLEAR key repeatedly until the MESSAGE CENTER displays "SELECT WORKOUT OR PRESS QUICK START". Or, after the last setting has been displayed and it is impossible to scroll forward by pressing ENTER, hold down the QUICK START key, and press CLEAR. The MESSAGE CENTER then displays the prompt to select a workout.

<b>OPTIONAL SETTINGS</b>		
<b>Setting</b>	<b>Default Value</b>	<b>Description</b>
MAX WORKOUT DURATION	60 minutes	This is the maximum possible duration for a workout. The value can range from 10 to 99.
ENGLISH/METRIC UNITS	ENGLISH* METRIC**	This option determines the units of weight measurement used by workouts.
WATTS DISPLAY ENABLE/ DISABLE (93S only)	DISABLED* ENABLED**	If this option is enabled, the MESSAGE CENTER displays the Watts equivalent of the step rate.
METS DISPLAY ENABLE/ DISABLE (93S only)	DISABLED* DISABLED**	If this option is enabled, the MESSAGE CENTER displays the Mets equivalent of the step rate.
CAL/HR DISPLAY ENABLE/ DISABLE	ENABLED* DISABLED**	If this option is enabled, the MESSAGE CENTER displays the number of calories burned per hour during the workout.
WATTS PROGRAM ENABLE/ DISABLE	DISABLED* ENABLED**	If this option is enabled, the Watts workout becomes an available workout on the stairclimber.
METS PROGRAM ENABLE/ DISABLE	DISABLED* ENABLED**	If this option is enabled, the Mets workout becomes an available workout on the stairclimber.

\*Applies to units programmed to perform measurements in English system.  
\*\*Applies to units programmed to perform measurements in Metric system.

# 6 SERVICE AND TECHNICAL DATA

## 6.1 PREVENTATIVE MAINTENANCE TIPS

The Life Fitness stairclimber is backed by the engineering excellence of Life Fitness and is one of the most rugged and trouble-free pieces of exercise equipment on the market today. Commercial Life Fitness products have proven to be durable in health clubs, colleges, military facilities, and other locations the world over. This same technology, engineering expertise, and reliability have gone into the Life Fitness stairclimber.

**NOTE:** *The safety of the equipment can be maintained only if the equipment is examined regularly for damage or wear. If maintenance is required, keep the equipment out of use until defective parts are repaired or replaced. Pay special attention to parts that are subject to wear as outlined in the Preventive Maintenance Schedule.*

**REMARQUE :** *pour conserver un matériel sûr, il convient de l'inspecter régulièrement afin de déceler tout signe d'usure ou d'endommagement. N'utilisez pas l'appareil tant que les pièces défectueuses n'ont pas été réparées ou remplacées. Portez une attention toute particulière aux pièces qui s'usent, comme indiqué ci-dessous.*

The following preventive maintenance tips will keep the Life Fitness stairclimber operating at peak performance:

- Locate the Life Fitness stairclimber in a cool, dry place.
- Clean the top surface of the pedals regularly.
- Keep the display console free of fingerprints and salt build-up caused by sweat.
- Use a **100% cotton cloth**, lightly moistened with water and mild liquid cleaning product, to clean the stairclimber. Other fabrics, including paper towels, may scratch the surface. **Do not use ammonia or acid-based cleaners.**
- Long fingernails may damage or scratch the surface of the console; use the pad of the finger to press the selection buttons on the console.
- Clean the housing thoroughly on a regular basis.

**NOTE:** *A non-abrasive cleaner and soft cotton cloth are strongly recommended for cleaning the exterior of the unit. At no time should cleaner be applied directly to any part of the equipment; apply the non-abrasive cleaner on a soft cloth, and then wipe the unit.*

## 6.2 INSPECTING AND CLEANING THE STAIRCLIMBER

Follow the schedule below to ensure proper operation of the product.

Follow the schedule below to ensure proper operation of the product.				
ITEM	WEEKLY	MONTHLY	BI-ANNUALLY	ANNUALLY
<i>Display Console</i>	C	I		
<i>Console Mounting Bolts</i>			I	
<i>Accessory Tray</i>	C	I		
<i>Frame</i>	C			I
<i>Plastic Covers</i>	C	I		

KEY: C=Clean; I=Inspect

## 6.3 TROUBLESHOOTING THE HEART RATE CHEST STRAP

### HEART RATE READING IS ERRATIC OR ABSENT ENTIRELY

- Repeat the electrode moistening procedure on the chest strap. See Section 3.2, titled *Heart Rate Monitoring* for details. The electrodes must remain wet to pick up and transmit accurate heart rate readings.
- Make sure the electrodes are flat against the skin.
- Wash the belt transmitter regularly with mild soap and water.
- Make sure the chest strap transmitter is within three feet (91 centimeters) of the heart rate receiver.
- The chest strap is battery-operated and will stop functioning when the battery runs out. Contact Life Fitness Customer Support Services for instructions on how to have the chest strap replaced. See Section 6.4, titled *How to Obtain Product Service*.

### HEART RATE READING IS ERRATIC OR EXTREMELY HIGH

If the chest strap is worn near sources of electromagnetic signals, these signals may be strong enough to elevate heart rate readings. Possible sources include:

- Television sets and/or antennas, cell phones, computers, cars, high voltage power lines and motor driven exercise equipment.
- Another heart rate transmitter within three feet, or one meter, may also cause abnormal heart rate readings.

## 6.4 HOW TO OBTAIN PRODUCT SERVICE

1. Verify the symptom and review the operating instructions. The problem may be unfamiliarity with the product and its features and workouts.
2. Locate and document the serial number of the unit. This number consists of three letters followed by six numbers. The serial number plate is located at the back end of the unit.

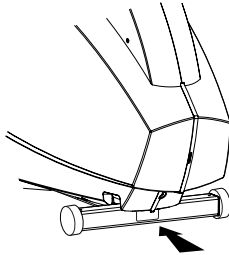

3. Contact Life Fitness Customer Support Services via the Web at: [www.lifefitness.com](http://www.lifefitness.com), or call the nearest Life Fitness Customer Support Services group:

For Product Service within  
the United States and Canada:

Telephone: (+1) 847.451.0036  
FAX: (+1) 847.288.3702  
Toll-free telephone: 800.351.3737

For Product Service Internationally:

*Life Fitness Europe GmbH*  
Telephone: (+49) 089.317.751.66  
FAX: (+49) 089.317.751.38

*Life Fitness (UK) LTD*  
Telephone: (+44) 1353.665507  
FAX: (+44) 1353.666018

*Life Fitness Atlantic BV*  
*Life Fitness Benelux*  
Telephone: (+32) 03.644.44.88  
FAX: (+32) 03.644.24.80  
Telephone: (+32) 87.300.942  
FAX: (+32) 87.300.943

*Life Fitness Italia S.R.L.*  
Telephone: (+39) 0472.835.470  
FAX: (+39) 0472.833.150  
Toll-free telephone: 800.438836

*Life Fitness Vertriebs GmbH*  
Telephone: (+43) 1615.7198  
FAX: (+43) 1615.7198.20

*Life Fitness Asia Pacific Ltd*  
Telephone: (+852) 2891.6677  
FAX: (+852) 2575.6001

*Life Fitness Latin America  
and Caribbean*  
Telephone: (+1) 847.288.3964  
FAX: (+1) 847 288.3886

*Life Fitness Brazil*  
Telephone: (+55) 11.7295.2217  
FAX: (+55) 11.7295.2218

*Life Fitness Japan*  
Telephone: (+81) 3.3359.4306  
FAX: (+81) 3.3359.4307

*Life Fitness Iberia*  
Telephone : (+34) 93 672 4660  
FAX : (+34) 93 672 4670



# 7 SPECIFICATIONS

## 7.1 93S STAIRCLIMBER SPECIFICATIONS

Designed use:	Heavy/Commercial
Maximum user weight:	350 pounds / 159 kilograms
Minimum user weight:	100 pounds / 45.3 kilograms
CONSOLE:	
Displays:	MESSAGE CENTER with heart rate, floors climbed, floors per minute, level, time, calories, calories per hour (when enabled), Watts (when enabled), and Mets (when enabled) WORKOUT PROFILE
Summaries:	Total elapsed time of workout, total calories burned, total floors climbed
Character size:	0.54 inches
Workouts :	Quick Start, Fat Burn, Cardio, Manual, Random, Hill, Heart Rate Hill, Heart Rate Interval, Extreme Heart Rate, Around the World, Kilimanjaro, Interval, Cascades, Speed Training, Foothills, Watts (when enabled), Mets (when enabled)
Heart rate monitor:	Polar telemetry heart rate monitoring system Polar heart rate chest strap (optional)
Intensity levels:	20
Stepping speed range	2 - 13 floors per minute
Step pedal size	6 inches x 11 inches / 15.2 centimeters x 27.9 centimeters
Maximum step height	13.5 inches / 34.3 centimeters
Drive type:	Belt/alternator
Accessory Tray:	Standard
Bullhorns:	Standard
Color:	Gray / Silver

### ASSEMBLED DIMENSIONS:

Length	48 inches / 122 centimeters
Width	32 inches / 81.2 centimeters
Height	64 inches / 162.6 centimeters
Weight	165 pounds / 75 kilograms

### SHIPPING DIMENSIONS:

Length	52 inches / 132 centimeters
Width	37 inches / 94 centimeters
Height	32 inches / 81 centimeters
Weight	201 pounds / 91 kilograms

## 7.2 90S STAIRCLIMBER SPECIFICATIONS

Designed use:	Heavy/Commercial
Maximum user weight:	350 pounds / 159 kilograms
Minimum user weight:	100 pounds / 45.3 kilograms
<b>CONSOLE:</b>	
Displays:	MESSAGE CENTER with heart rate, floors climbed, floors per minute, calories, calories per hour (when enabled), Watts (when enabled), and Mets (when enabled) WORKOUT PROFILE
Summaries:	Total elapsed time of workout, total calories burned, total floors climbed
Character size:	0.54 inches
Workouts:	Quick Start, Fat Burn (if telemetry option is installed), Cardio (if telemetry option is installed), Manual, Random, Hill
Heart rate monitor:	Polar telemetry heart rate monitoring system (optional) Polar heart rate chest strap (optional)
Intensity levels:	20
Stepping speed range	2 - 13 floors per minute
Pedal size	6 inches x 11 inches / 15.2 centimeters x 27.9 centimeters
Maximum step height	13.5 inches / 34.3 centimeters
Drive type:	Belt/alternator
Accessory Tray:	Optional
Bullhorns:	Optional
Color:	Gray / Silver

### ASSEMBLED DIMENSIONS:

Length	48 inches / 122 centimeters
Width	32 inches / 81.2 centimeters
Height	64 inches / 162.6 centimeters
Weight	155 pounds / 70.3 kilograms

### SHIPPING DIMENSIONS:

Length	52 inches / 132 centimeters
Width	37 inches / 94 centimeters
Height	32 inches / 81 centimeters
Weight	191 pounds / 86.6 kilograms



M051-00K47-A033

**Life Fitness World Headquarters**  
10601 W. Belmont Avenue  
Franklin Park, IL 60131