

C532i, C556i Navy Elliptical Fitness Crosstrainer

Warning: This service manual is for use by Precor trained service providers only. If you are not a Precor Trained Servicer, you must not attempt to service any Precor Product; Call your dealer for service.

This document contains information required to perform the majority of troubleshooting, and replacement procedures required to repair and maintain this product.

This document contains general product information, software diagnostic procedures (when available), preventative maintenance procedures, inspection and adjustment procedures, troubleshooting procedures, replacement procedures and electrical block and wiring diagrams.

To move directly to a procedure, click the appropriate procedure in the bookmark section to the left of this page. You may “drag” the separator bar between this page and the bookmark section to change the size of the page being viewed.

Section One - Things You Should Know

Right, Left, Front, and Back Conventions

In this manual, right, left, front, and back are from the perspective of a user standing on the EFX C532i, C556i Navy, facing the display enclosure.

Warning and Caution Statements and General Safety Guidelines

Warning statements indicate a particularly dangerous activity. Warning statements you will find in this manual include:

- Removing the covers exposes high voltage components and potentially dangerous machinery. Exercise extreme caution when you perform maintenance procedures with the hood removed.
- During service operations you will be very close to moving machinery and high voltage components. When you perform maintenance procedures with the covers removed, remove jewelry (especially from ears and neck), tie up long hair, remove neck ties, and do not wear loose clothing.
- Exercise caution when touching any wire or electrical component during EFX operation.

Caution statements are intended to prevent damage to the EFX as a result of the current activity. Caution statements included in this manual are listed below:

- Notice the orientation notch on the lower PCA PROM. These components must be positioned with the same notch orientation.

Safety guidelines you should know and follow include:

- Read the owner's manual and follow all operating instructions.
- Visually check the EFX before beginning service or maintenance operations. If it is not completely assembled or is damaged in any way, exercise extreme caution while operating and checking the EFX.
- When operating the EFX, do not wear loose clothing. Do not wear shoes with heels or leather soles. Check the soles of your shoes and remove any embedded stones. Tie long hair back.
- Do not rock the unit. Do not stand or climb on the handlebars, display enclosure, or cover.
- Do not set anything on the handlebars, display enclosure, or cover. Never place liquids on any part of the EFX other than a water bottle in the water bottle holder during normal operation.
- To prevent electrical shock, keep all electrical components away from water and other liquids.

- Do not use accessory attachments that are not recommended by the manufacturer-such attachments might cause injuries.

General Information

For the latest exploded view, part number and part pricing information, visit the Precor dealer website at “www.precor.com/connection”.

Required Tools and Equipment

The following list is a summary of the tools and equipment required when you service Precor's EFX.

TOOLS

Phillips and flat-head screwdrivers

Standard and metric Allen wrench sets
Open-end wrench set

Drive ratchet and ratchet set
Socket drive Allen set

Chip puller
Rubber mallet
Snap ring pliers
100 ft./lb. torque wrench
300 in./lb. torque wrench
Automotive belt tension gauge

EQUIPMENT

Digital multimeter

Supplies

Blue Loctite

Cable ties

Spares

Data cables

Procedure 2.1 - Accessing the Hardware Validation Program

The EFX diagnostic software cycles through the following tests:

Hardware Validation

- Display Test
- Keyboard Test
- Heart Rate
- Brake
- RPM
- Battery

Procedure

Note:

Use the **RESET** key and the ten key keypad to enter the access code.

1. Access the diagnostic program by pressing, keys **RESET,5,1,7,6,5,7,6,1**, sequentially.

Diagram 2.1 - C532i Display



Diagram 2.2 - C556i Navy Display

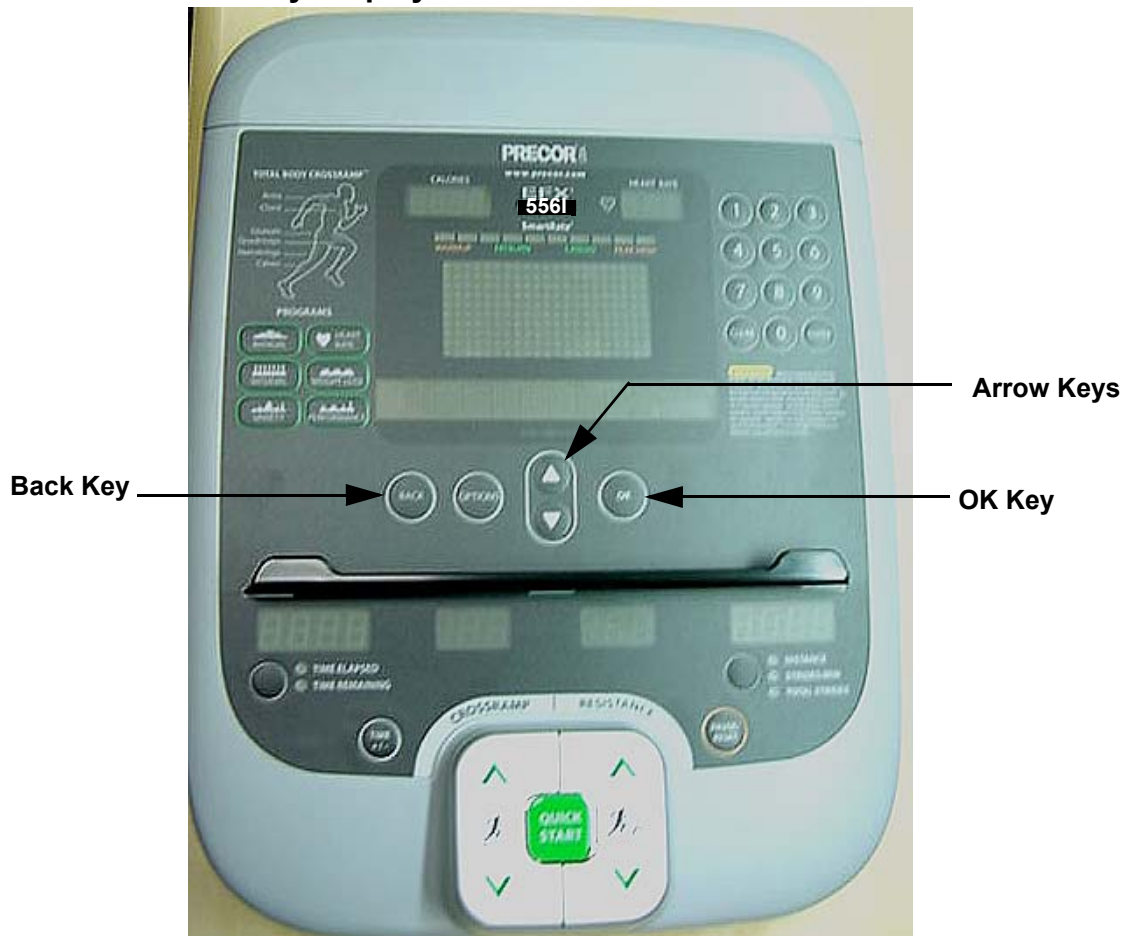

2. The test name **HARDWARE VALIDATION** will scroll once across the display.
3. The test name "**DISPLAY**" will be displayed. Press the **OK** key to enter the display test or an **▲, ▼** key to proceed to a different test.
4. Each time you press the **OK** key a different block of LED's will illuminate. Check each LED in each block to ensure that all are functioning. As you move through the LED blocks, one press of the **OK** key will cause all of the LED's to be off.
5. Press the **CANCEL** key (532i) or the **BACK** key (C56i Navy) to proceed to the keyboard test.
6. The test name "**KEYBOARD**" will be displayed. Press the **OK** key to enter the keyboard test or an **▲, ▼** key to proceed to a different test.
7. A graphical representation of all the keys on the keyboard will be displayed. When a key is pressed the representation of the key on the display will be turned "off". Check all of the keys on the keyboard in this manner.
8. Press and hold the **CANCEL** key (C532i) or **BACK** key (C556i Navy) for several seconds to proceed to the heart rate test.

9. The test name "**HEART RATE**" will be displayed. Press the **OK** key to enter the heart rate test or an **▲, ▼** key to proceed to a different test.
10. Both the hand held heart rate and wireless heart rate function must be tested. A chest strap heart rate transmitter or a heart rate test transmitter must be used to test the wireless heart rate function.
11. When a heart rate signal is received, the unfiltered and filtered heart rates will be displayed. In addition the Polar heart rate will be displayed in the "Heart Rate" window. The red heart and the smart rate LED's will illuminate.
12. Press the **CANCEL** key (532i) or the **BACK** key (C56i Navy) to proceed to the brake test (C532i) or machine test (C556i Navy).
13. If you are testing a C556i Navy EFX skip to step 21, if you are testing a C532i continue with step 14.
14. The test name "**BRAKE**" will be displayed. Press the **OK** key to enter the brake test or an **▲, ▼** key to proceed to a different test.
15. Powerbits will be displayed in the upper window and the resistance level will be displayed in the lower middle window. Pressing the resistance **▲, ▼** keys will change the number of power bits being applied to the eddy current system., ranging from 60 to 170 powerbits. Because this is a self powered EFX, you must pedal fast enough to keep the EFX powered up and the resistance up, otherwise the powerbits will be below the selected setting.
16. Press the **CANCEL** key to proceed to the RPM test.
17. The test name "**RPM**" will be displayed. Press the **OK** key to enter the RPM test or an **▲, ▼** key to proceed to a different test.
18. The current RPM will be shown as "**PULSE XX**". The pulses are updated in real time and will display the actual pulse count.
19. Press the **CANCEL** key to proceed to the battery test.
20. Skip to step 25.
21. The test name "**MACHINE TEST**" will be displayed. Press the **OK** key to enter the brake test or an **▲, ▼** key to proceed to a different test.
22. The test name "**BRAKE**" test will be displayed.
23. The powerbits will be displayed as **PWRB XX**. Press the **BACK** key to proceed to the RPM test.
24. The revolutions per minute will be displayed as **RPM XX**. Press the **BACK** key to proceed to the CROSSRAMP test.
25. The test name "**CROSSRAMP**" will be displayed. Press the **OK** key to enter the crossramp

test or an ▲, ▼ key to proceed to a different test.

26. The A/D number (incline position number) will be displayed as **A/D XX**. Press the **CANCEL** key (532i) or the **BACK** key (C56i Navy) to proceed to the auto level test.
27. The test name "**AUTO LEVEL**" will be displayed. Press the **OK** key to enter the auto level test or an ▲, ▼ key to proceed to a different test.
28. The auto level incline position will be displayed, press an ▲, ▼ key to change the auto level.
29. Press the **CANCEL** key (532i) or the **BACK** key (C56i Navy) to proceed to the battery test.
30. The test name "**BATTERY**" will be displayed. Press the **OK** key to enter the battery test or an ▲, ▼ key to proceed to a different test.
31. The battery voltage will be displayed as "**XX.X VDC**".
32. Press the **CANCEL** key to return to the Display test or the **RESET** key to exit.
33. You may press the **RESET** key at anytime in the hardware validation program to exit the hardware validation program.

Procedure 2.2 - Accessing the Information Display

Procedure

1. With the **PRECOR EFX** banner displayed, press keys **RESET,6,5**, sequentially.

Diagnostics Test

Odometer

Hour meter

U-Boot Software version

U-Base Software version

Lower software version

Metrics Board SW Part Number (C532i only)

Serial Number

Usage Log

Error log

2. The test name "**DIAGS - INFORMATION DISPLAY**" will scroll once across the display. Press the **OK** key to proceed to odometer or use the **▲**, **▼** keys to proceed a different display.
3. The display name "**ODOMETER**" will be displayed, press the **OK** key, the odometer value will be displayed, as total strides accumulated.
4. Press the **CANCEL** (C532i) or the **BACK** (C556i Navy) key to proceed to the hour meter display.
5. The display name "**HOURLY METER**" will be displayed, press the **OK** key, the hour meter will be displayed, as the total number of hours of use. Fractional parts of an hour are stored internally, the display will be truncated to the nearest full hour.
6. Press the **CANCEL** (C532i) or the **BACK** (C556i Navy) key to proceed to the U-Boot SW display.
7. The display name "**U-BOOT SW**" will be displayed, press the **OK** key, the U-Boot software part number will be displayed.
8. Press the **CANCEL** (C532i) or the **BACK** (C556i Navy) key to proceed to the U-Base SW display.
9. The display name "**U-BASE SW**" will be displayed, press the **OK** key, the U-Base software part number will be displayed.
10. Press the **CANCEL** (C532i) or the **BACK** (C556i Navy) key to proceed to the Lower SW display.
11. The display name "**LOWER SW**" will be displayed, press the **OK** key, the lower software part number will be displayed.

12. Press the **CANCEL** (C532i) key to proceed to the Metrics board SW display or the **BACK** key (C556i Navy) to proceed to the serial number display, skip to step.16.
13. The display name "**METRICS BOARD SW PART NUMBER**" will be displayed, press the **OK** key, the metrics board software part number will be displayed.
14. Press the **CANCEL** (C532i) or the **BACK** (C556i Navy) key to proceed to the serial number display.
15. The display name "**SERIAL NUMBER**" will be displayed, press the **OK** key, the serial number will be displayed. If the serial number is not present it can be uploaded per Procedure 2.5.
16. Press the **CANCEL** (C532i) or the **BACK** key (C556i Navy) key to proceed to the usage log display.
17. The display name "**USAGE LOG**" will be displayed, press the **OK** key.
18. The program used and the time the program was used will be displayed.
19. The keys **▲**, **▼** will scroll you through the list of programs that have been used.
20. Press the **CANCEL** (C532i) or the **BACK** (C556i Navy) key to proceed to the error log display.
21. The display name "**ERROR LOG**" will be displayed, press the **OK** key.
22. The first error log entry will be displayed "**1: ERXX XX STRIDES XX HRS**".
23. Pressing the **▲**, **▼** keys will move you through the log entries. Press the **OK** key to view the selected error. Entry 1 will be the most recent error log entry, with each succeeding entry being older than the preceding entry.
24. If the error log is empty "**NO ERRORS**" will be displayed.
25. Pressing and holding the **QUICK START** key for 2 seconds will cause the prompt **CLEAR?** to be displayed, holding the **QUICK START** for an additional 2 seconds will clear all existing entries from the error log. The display will confirm that the error log has been cleared by displaying **OK**. The display will revert to the first log entry and show it as a null entry (**1: ---**). If the **QUICK START** key is not held for a minimum of 4 seconds, the error log will not be cleared.
26. Press the **RESET** key to exit the diagnostics display program.

Procedure 2.3 - Accessing the Club Settings Display

Selecting United States standard units causes information to be displayed in miles. Information is displayed in kilometers if metric units are selected. After you select a measurement standard, the software accumulates and records workout information in the units of the measurement standard selected.

Procedure

1. With the **PRECOR EFX** banner displayed, press keys **RESET,5,6,5,1,5,6,5** sequentially.

Diagnostics Test

Select Language

Select Units

Set Max. Workout Time

Set Max. Pause Time

Set Cool Down Time

Set Custom Courses (C556i Navy, only)

2. The display name "**SELECT LANGUAGE**" will be displayed, press the **OK** key to proceed to the select units display or an **▲**, **▼** key to proceed to a different display
3. Use the **▲**, **▼** keys to scroll the list of languages, when the desired language is displayed press the **OK** key to accept the desired language and exit the select language display.
4. Press the **CANCEL** (C532i) or the **BACK** (C556i Navy) key to proceed to the select units display.
5. The display name "**SELECT UNITS**" will be displayed, press the **OK** key to proceed to the select units display or an **▲**, **▼** key to proceed to a different display.
6. One of two measurement standards will be displayed, **U. S. Standard** or **Metric**.
7. If **U. S. Standard** is selected, weights will be in pounds and distances will be in miles. If **Metric** is selected, weights will be in kilograms and distances in kilometers.
8. Pressing any **▲**, **▼** key will toggle the units of measure between **US Standard** and **Metric**.
9. Press the **CANCEL** (C532i) or the **BACK** (C556i Navy) key to proceed to the set max workout time display.
10. The display name "**SET MAX WORKOUT TIME**" will be displayed, press the **OK** key to proceed to the set max pause time display or an **▲**, **▼** key to proceed to a different display.
11. The current workout time will be displayed. Pressing any **▲**, **▼** key will increase or decrease the maximum pause time between 1 and 240 minutes or no time limit.
12. Press the **CANCEL** (C532i) or the **BACK** (C556i Navy) key to proceed to the set max. pause time display.

13. The display name "**SET MAX PAUSE TIME**" will be displayed, press the **OK** key to proceed to the set max pause time display or an **▲**, **▼** key to proceed to a different display.
14. The current pause time will be displayed. Pressing any **▲**, **▼** key will increase or decrease the maximum pause time between 1 and 120 seconds.
15. Press the **CANCEL** (C532i) or the **BACK** (C556i Navy) key to proceed to the set cool down time display.
16. The display name "**SET COOL DOWN TIME**" will be displayed, press the **OK** key to proceed to the set cool down time display or an **▲**, **▼** key to proceed to a different display.
17. The current cool down time will be displayed. Pressing any **▲**, **▼** key will increase or decrease the cool down time between 0 and 5 minutes.
18. Press the **BACK** key (C556i Navy) to proceed to the set custom courses display or the **Cancel** key (C532i) to exit the set cool down display, skip to step 22.
19. Press the **OK** key to enter the set custom courses display.
20. Press the **BACK** key to exit the set custom courses display
21. Press the **RESET** key to exit the set user parameters program.

Procedure 2.4 - Documenting Software Problems

When a problem is found with either the software or upper or lower PCA's, record the information listed below. If you isolated the problem to either the PROM, upper PCA, or lower PCA, include the information you have recorded with the malfunctioning PROM or PCA when you ship it to Precor.

When a problem occurs, record the following information:

- Model and serial number
- Software version numbers for upper and lower PCA's
- User and program number running when the problem occurred
- A description of:
 - a. What happened or failed to happen.
 - b. The action taken by the user just before the problem occurred.
 - c. Problem-related information (such as how far into the program the problem occurred, the work level being used when the problem occurred, etc.).
- The frequency of occurrence.

Contact Precor technical support at 800-347-4404 to receive a return tag.

Procedure 2.5 - Uploading Upper PCA Software and Serial Number Information

Using Windows CSAFE

There are three ways to use **Windows CSAFE**.

First, you can use it as a query tool to send various **CSAFE** requests to the machine. When you do this, the program responds with both the raw hexadecimal response, and the decoded response.

Second, you can use the program to update (flash) the firmware of a machine.

Third, you can enter a fitness machine's serial number.

It should be noted that Windows **CSAFE** is not compatible with Windows Vista.

Use the options menu to set the **COM** port that you're using with the program. You may need to do this only once, or you may need to do this each time you run the program, depending on your computer.

You may also use the options menu to set the default a90 directory where you store your firmware. This will facilitate the usage of different directories for consumer display software, versus their commercial counterparts. Like the **COM** port settings, the program may or may not remember your directory preference between runs.

There are 3 directories that were created for you during installation of the software. They are underneath the same directory in which you installed the program. You'll find one each for consumer, commercial, and experience line machines. The commercial folder is the default.

Uploading software and serial numbers into Upper PCA boards

This procedure is for Precor products manufactured with upper pca's that utilize flash memory rather than a firmware chip for software storage. Call Precor technical support at 800-347-4404 if you are unsure of the type of software storage in the unit being serviced.

Tools Required

Laptop computer, data cable part number **47389-101**, serial to **RJ-45** connector adaptor, **USB** to serial adapter (if necessary), **WindowsCSAFE** program (downloaded from Precor Connection website). The **RJ-45** connection for data that is on most laptops will not work.

Uploading software

Download the appropriate software from Precor Connection for Experience, Commercial, or Residential. The Word document in the zip file will help you to choose the correct software for the unit you are working on.

Open the **WindowsCSAFE** program. It may be necessary to set program to find the file you want to access. On the tool bar menu choose Options, then set **a90** folder. In the box that opens, locate the folder you downloaded the files to, then hit **OK**.

Now you should ensure that the **COM** port is properly set. Choose **Options**, then **Set COM Port**, and choose the proper port from the drop down menu.

Using the drop down menu under **Flash Firmware** choose the correct file for the equipment you are servicing. Ensure that the power to the lower pca is removed, and that the lower pca has no residual power. Connect the data cable between the computer and the **CSAFE** port on the upper pca.

Press the **Flash** button, the data box at the bottom of the screen will prompt that upload will occur when the upper pca is powered. Apply power to the unit. The upper display should not illuminate, if it does you don't have a proper connection between the computer and the upper pca, or the lower board was not fully discharged. Check the **COM** port setting and the lower pca, then when both are correct hit Flash again.

When the connection is properly made the data box will indicate that upload is in progress. The Progress bar will show the progress of the upload, which may take as much as 5 minutes, depending on the download speed of the computer.

When the upload is complete, disconnect the cable between the computer and the unit, and power the unit down, allowing the lower board to completely discharge. Power up the unit, and verify the software version from the display.

Uploading serial numbers

Entering the serial number into the upper board of the Experience Line equipment, or other upper pca's, requires downloading and installing the latest version of the **WinCSAFE** software from the Precor Connection Website. Once the software is installed, follow these steps.

1. Click on the **WinCSAFE 2.0** icon to open the program.
2. Click on the **Options** tab and select the correct **Com** port.
3. Connect the cable from the computer's **RS232 I/O** port to the **CSAFE** port on the equipment's upper pca.
4. Be sure to have the equipment powered up for the following steps. If the unit is a self-powered unit, you must pedal the unit to provide power before the data will be written.
5. Enter the serial number data into the **Set Serial Number** window.
6. Click on the Send button to write the information into the equipment.
7. Using the standard diagnostics routine, verify that the serial number has been written to the upper pca.
8. Once verified disconnect the cable from the upper pca.

Section Three - Preventive Maintenance

Preventive maintenance measures are either scheduled or unscheduled. Scheduled preventive maintenance activities are included here so that you are aware of the preventive measures to be performed on a regular basis.

Regular Preventive Maintenance (Owner)

Cleanliness of the EFX and its operating environment will keep maintenance problems and service calls to a minimum. Precor recommends that you perform the following preventive maintenance schedule.

At the End of Each Day

Wipe down the stairarms, ramps, wheels and frame with a damp cloth.

Every Week

Wipe the surface of the electronic console with a slightly-damp sponge or soft cloth. Dry with a clean towel.

CAUTION

Keep water away from electronic components to prevent shock.

On-Site Preventive Maintenance (Service Technician)

Perform the following preventive maintenance tasks each time you are called to service a EFX:

Examine the belts for wear, cracks or other signs of deterioration and replace if necessary.

Check the LED's mounted on the upper PCA and the function keys displayed on the electronic console by performing Procedure 2.1.

Visually examine all wires and check connectors and wire connections. Secure connections and replace wiring as necessary.

Check unit operation per Section Four.

Section Four - Checking EFX Operation

This section provides you with a quick method of checking EFX operation. Check the operation of the EFX at the end of most maintenance procedures.

Procedure

1. Start striding on the EFX or plug the optional external power supply (when available) into the EFX and the AC outlet.
2. Press **QUICK START**.
3. Select Resistance Level 1.
4. Operate the EFX for 4–5 minutes. As you operate the EFX, concentrate on the operating sounds made by the unit. Be on the alert for unusual rubbing, hitting, grinding, or squeaking noises.
5. If the EFX makes unusual noises or the electronic display does not change appropriately, troubleshoot per section 6.4.
6. Press the **RESISTANCE ▲** key until you reach Resistance Level 10. Operate the EFX for another 2–3 minutes.
7. If the EFX resistance does not change or the operation of the EFX feels inconsistent compared with Resistance Level 1, troubleshoot per section 6.4.
8. Press the **RESISTANCE ▲** key until you reach Resistance Level 20. Operate the EFX for another 2–3 minutes.
9. If the resistance of the EFX does not change or the EFX operation feels inconsistent with Resistance Levels 1 and 10, troubleshoot per Procedure 6.4.
10. Check the LED's mounted on the upper PCA and the function keys displayed on the electronic console by performing Procedure 2.1.
11. Thoroughly test all functions per Section Four.

Procedure 5.1 - Measuring the Resistance of a Generator

Caution

If an external power supply is connected to the EFX, disconnect the external power supply from the EFX before continuing with this procedure.

Procedure

1. Remove the access cover, top cover, left and right side covers. See Procedure 7.1.
2. Remove the two screws that retain the black plastic shield. Remove the black plastic shield from the EFX.
3. Remove the red battery lead from the lower PCA. See Diagram 5.1.

WARNING

Before continuing with this procedure, review the Warning and Caution statements listed in Section One, Things You Should Know.

4. Set the ohmmeter to a range that will conveniently read up to 50 Ω .
5. Remove the six phase generator connector from the lower PCA, refer to Diagram 5.1, below.
6. With an ohmmeter, read between terminals 1 & 2, terminals 1 & 3, terminals 1 & 5, terminals 1 & 6, and terminals 1 & 7 on the six phase generator connector (J1). Each of the readings should be between 36 Ω and 40 Ω .
7. If any of the readings are significantly high or significantly low, remove the intermediate cable from the generator and perform the same measurements as in step 4 on the generator connector. If the readings are now correct check and or replace the intermediate cable refer to Diagram 5.1. If the readings are still incorrect, remove the six phase generator.
8. Replace the generator per Procedure 7.10. Reconnect the intermediate cable removed in step 5 to the replacement generator and the lower PCA.
9. Reconnect the red battery lead to terminal M6 of the lower PCA.
10. Set the black plastic shield in its mounting position and fasten it with the screws removed in step 2.
11. Set the right side of the rear cover in its mounting position and rotate it clockwise. Ensure that the cover is fully engaged and fasten it with the screw removed in step 1.

Diagram 5.1 - Lower PCA

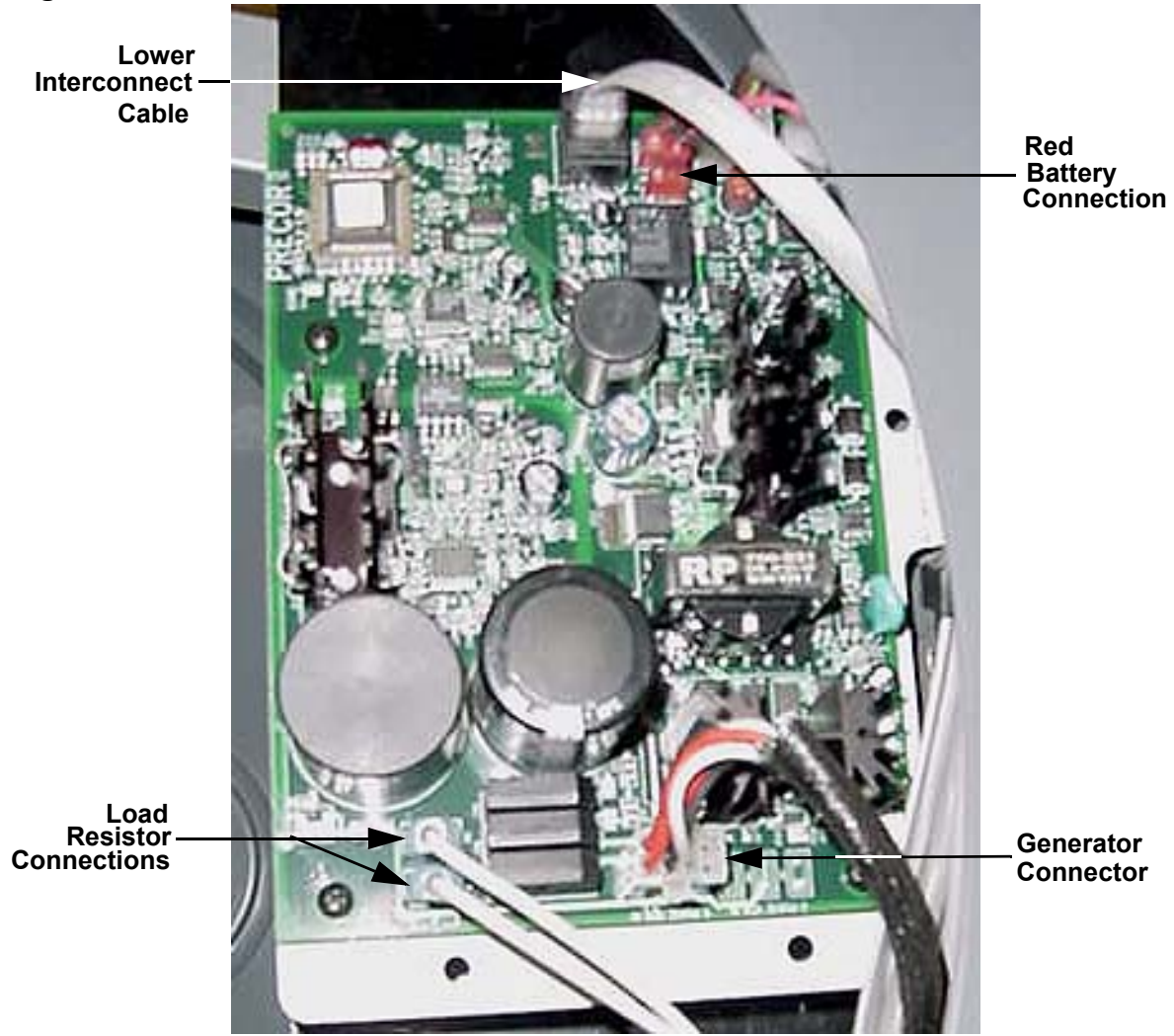

Procedure 5.2 - Inspecting and Adjusting Belt Tension

Procedure

1. Remove the access cover, top cover, left and right side covers. See Procedure 7.1.

WARNING

Before continuing with this procedure, review the Warning and Caution statements listed in Section One, Things You Should Know.

WARNING

If the EFX has been in recent use, the load resistors and mounting bracket may be extremely hot.

2. Remove the two screws that retain the black plastic shield on the left side of the EFX. Remove the black plastic shield from the EFX.
3. Place a automotive or equivalent belt tension gauge on the input belt as shown in Diagram 5.2.

Diagram 5.2 - Input Belt Tension Measurement



Left Side Adjustment Bolt

4. The belt gauge should read approximately 160 lbs. If the belt tension is significantly high or low the belt tension may be adjusted using the adjustment bolts shown in Diagram 5.2. To adjust the belt tension first straighten the locking tabs on both bolts. When adjusting the tension, turn both bolts equal amounts. When the adjustment is complete the step up pulley shaft must remain perpendicular to the frame and drive belt. Turning the adjustment bolts clockwise will increase belt tension, turning the adjustment bolts counter-clockwise will decrease belt tension.
5. Changing the tension of the input drive belt will also affect the tension of the generator belt. If the input belt tension has been changed, continue with step 7.
6. Place a automotive or equivalent belt tension gauge on the generator belt as shown in Diagram 5.3.

Diagram 5.3 - Generator Belt Tension Measurement

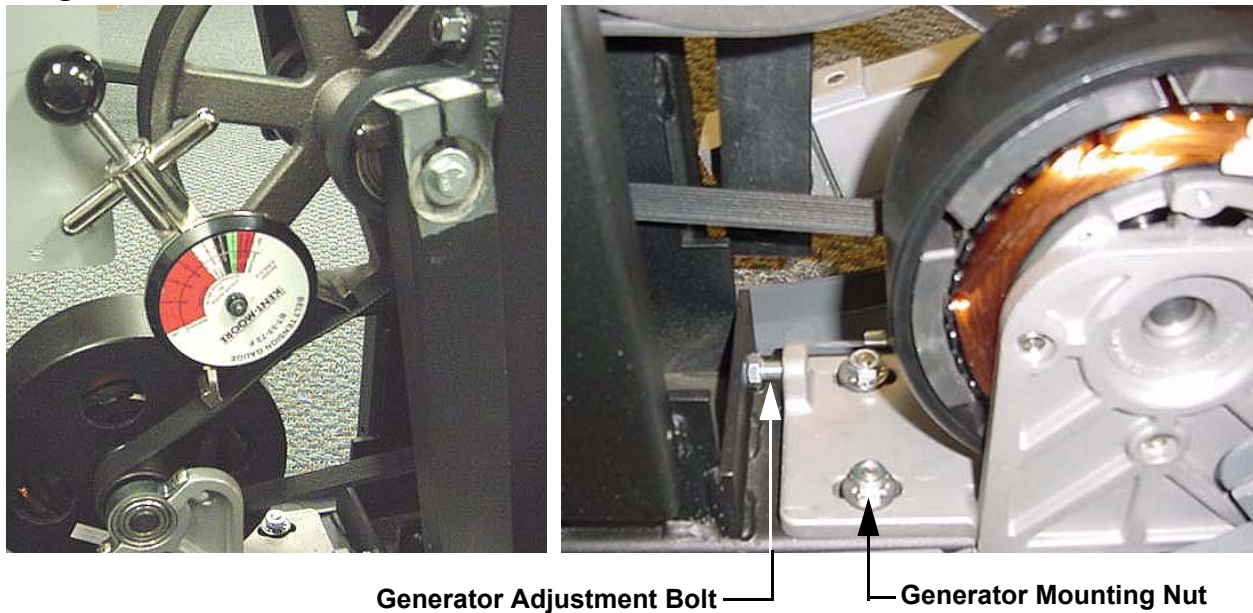

7. The belt gauge should read approximately 110 lbs. If the generator belt tension is significantly high or low, it may be adjusted using the adjustment bolt shown in Diagram 5.3. First loosen, but do not remove the four generator mounting nuts. Thread the adjustment bolt into or out of the generator to change the belt tension. When the tension is correct, tighten the locking nut. Tighten and torque the four generator mounting nuts to 200 inch pounds.
8. If either the input pulley belt or the generator belt is being replaced with a new belt, the belt tension should be set 20 lbs. higher than the previous readings. Therefore a new input pulley belt should be tensioned to 180 lbs. and a new generator belt should be tensioned to 130 lbs. Over time and use the belts will “relax” and the tensions will be as stated in steps 4 and 7.
9. Reconnect the red battery lead to terminal M6 of the lower PCA.
10. Replace the covers removed in step 1..

Procedure 5.3 - Calibrating the Lift Motor

1. In order to calibrate the lift motor, it is necessary to disconnect the lift motor from the ramp assembly.
2. Remove the two bolts that retain the lift yoke to the ramp assembly. Support the lift motor and ramp assembly as you separate the lift yoke from the ramp assembly. Lower the ramp assembly until it is resting on the rear lift cover. (See Diagram 5.4)

Diagram 5.4 - Lift Motor Calibration

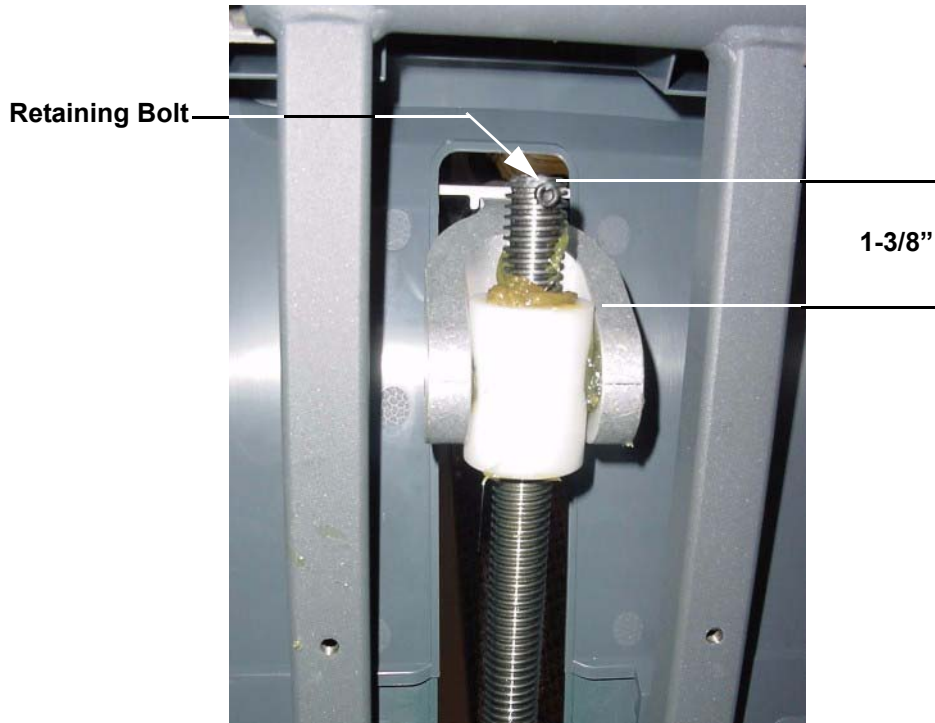

3. Pedal on the EFX or operate it on the external A.C. adapter. Enter the diagnostics routine per Procedure 2.1 and proceed to the crossramp test.
4. Operate the **CROSSRAMP ▲** or **CROSSRAMP ▼** keys as required to set the lift A/D number to 182.
5. Rotate the lift yoke on the lift motor drive screw until the distance from the upper surface of the plastic nut in the lift yoke to the end of the drive screw is 1-3/8". If the lift motor drive screw rotates the lift calibration number will no longer be 182. The lift calibration number must be 182 and the distance measurement must be correct for the lift calibration to be correct. See Diagram 5.4.
6. Raise the ramp assembly to a convenient height and slide the lift yoke into the ramp assembly. Hand tighten the lift yoke mounting bolts and then torque them to 240 inch pounds (20 foot pounds).
7. Thoroughly test all lift related functions per Section Four.

Procedure 6.1 - Troubleshooting the Lower and Upper Data Cable

Typical symptoms associated with a defective data cable are either an error 30 or no power to the upper PCA. This procedure requires that you have a known good upper data cable, lower data cable and mid-point connector.

1. If you are troubleshooting an error 30, 31 or 32 continue with step 2, otherwise see Procedure 6.3.
2. Expose the upper top of outrigger tubes by removing the upper and lower display bracket covers from the rear of the display.
3. Remove the three bolts that fasten the top, remove the four bolts that fasten the bottom and remove the clamp from the center of the left outrigger tube. See Diagram 6.1.

Diagram 6.1 - Left Outrigger Tube



Top



Bottom



Center

4. There is a data cable in the left outrigger tube, care must be taken when removing the outrigger tube to avoid damaging the data cable. Carefully remove the left outrigger tube from the shaft at its center point.
5. Slide the upper data cable, the cable in the outrigger tube, out of the main frame tube to expose the mid-point connector and the lower data cable.
6. Disconnect both cables from the mid-point connector and replace the mid-point connector with a known good mid-point connector. If the mid-point connector does not correct the problem, replace the original mid-point connector and continue with step 7. If the mid-point connector corrects the problem, skip to step 12.
7. Remove the top, left and right rear covers per procedure 7.1.
8. Disconnect the lower data cable from the lower PCA and the mid-point connector. Substitute a known good data cable from the lower PCA to the mid-point connector. It is not necessary to route the test data cable through the frame tube, for convenience route it externally. Ensure that the external cable does not interfere with crank arm movement.

9. If the lower data cable corrects the problem, replace the cable per Procedure 7.4. If the lower data cable does not correct the problem, re-connect the original lower data cable to the lower PCA and mid-point connector and continue with step 10.
10. Remove the cover from the rear of the display. Disconnect the upper data cable from the mid-point connector and the upper PCA. See Diagram 6.2. Substitute a known good data cable from the upper PCA to the mid-point connector. It is not necessary to route the test data cable through the frame tube, for convenience route it externally.

Diagram 6.2 - Upper Display Cable



11. If the upper data cable corrects the problem, replace the cable per Procedure 7.4. If the upper data cable does not correct the problem, re-connect the original upper data cable to the mid-point connector and the upper PCA and continue with step 10.
12. Carefully, set the outrigger tube in its mounting position and fasten it with the bolts and clamp removed in step 3.
13. Replace the covers removed in step 2.
14. If you have performed all of the procedures above and have been unable to correct the problem, call Precor customer service.

Procedure 6.2 - Troubleshooting the Keypad and Upper PCA

If the function keys on the electronic console are unresponsive, the problem may be either the upper PCA or keypad.

Procedure

WARNING

Before continuing with this procedure, review the Warning and Caution statements listed in Section One.

1. If the EFX powers up and functions normally until a particular key(s) is pressed, skip to step 9. If a **“STUCK KEY”** message is immediately displayed when the EFX is powered up, continue with the next step.
2. This condition may be caused by either one of the keypads or upper PCA. Power the EFX on by pedaling or with the external power supply. Remove the display bracket cover from the rear of the display. Disconnect heart rate cables. Disconnect the data cable from the Upper PCA. See Diagram 6.2.
3. Remove the four screws that fasten the rear cover to the display. Release the six display face mounting clips and lift the display off of the display. Disconnect the heart rate cable from the heart rate connector.
4. Remove the keypad cable and the D-Pad cable from the upper PCA. See Diagram 6.3.

Diagram 6.3 - Display Face, Rear View

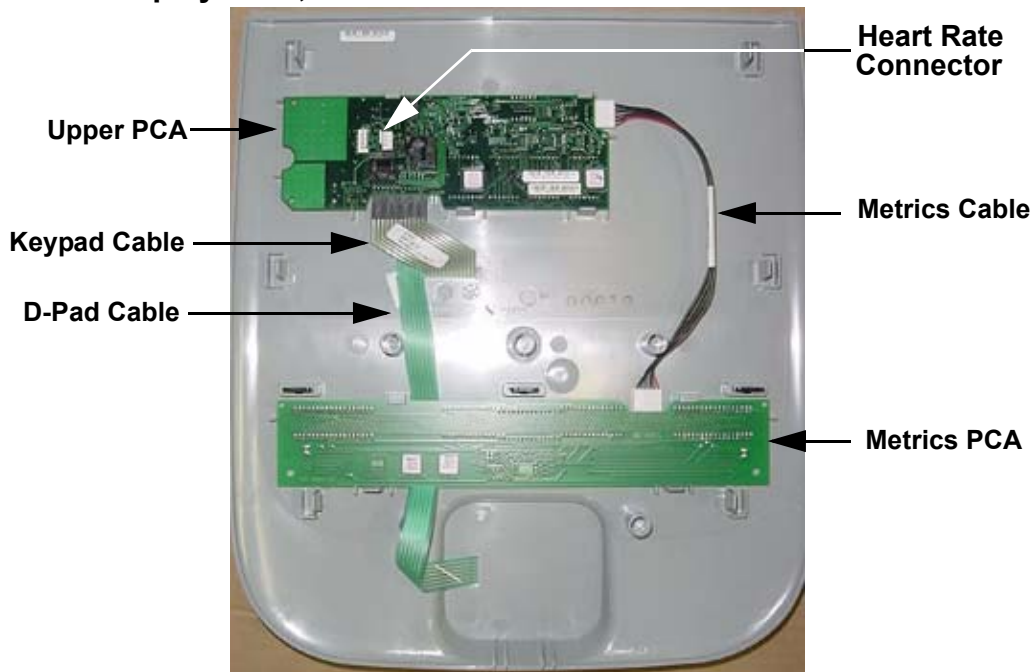

5. Set the display back in its mounting position and reconnect the data cable.
6. If a "**STUCK KEY**" message is immediately displayed when the EFX is powered up, replace the upper PCA.
7. If a "**STUCK KEY**" message is not displayed when the EFX is powered up, replace the display housing front panel. The display housing front panel is equipped with the D-pad and keypad.
8. If you have performed all of the procedures above and have been unable to correct the problem, call Precor customer service.
9. Access the diagnostics program per procedure 2.1.
10. Test the keypad per Procedure 2.1.
11. If all of the keys test good, the problem may be user error or a key function that is normally disabled during a particular user program.
12. If one or more keys do not function correctly, either the keypad (display housing) or upper PCA could be defective. Replace the display and repeat steps 9 - 11. If the display housing did not correct the problem, re-install the original display housing and replace the upper PCA.
13. If you have performed all of the procedures above and have been unable to correct the problem, call Precor customer service.

Procedure 6.3 - Upper Display does not Illuminate

1. Because this is a self powered unit, the display will not illuminate until the EFX is used or the optional external power supply is equipped. If the optional external power supply is equipped, the display should be constantly illuminated. If the optional external power supply is not equipped, the unit must be used at a stride rate of 20 strides per minute or higher for the display to illuminate.
2. If the optional external power supply is not equipped, skip to step 5.
3. Disconnect the optional external power supply from the EFX and measure between the inner and outer sleeves of the power supply's output jack with a DC voltmeter. You should measure approximately 18 VDC.
4. If the voltage measured in step 3 was significantly low, replace the optional external power supply. If the voltage measured in step 3 was 0 Vdc, disconnect external power supply from its AC outlet and measure the voltage at the AC outlet. If the AC outlet voltage is normal replace the optional external power supply. If the AC outlet voltage is significantly low or 0 Vdc, the AC system must be inspected by an electrician.
5. Troubleshoot the generator per Procedure 6.4.
6. If the generator was found to be good, the problem will be in either the lower PCA, upper PCA or the upper to lower PCA interconnect cables.

Warning

Because this is a self powered unit, it will either be necessary to either equip the unit with the optional external power supply or have an assistant pedal on the unit while voltage measurements are being taken. Because of the danger of working on the unit while it is in motion using the optional external power supply is strongly recommended.

7. Remove the rear cover and disconnect the interconnect cable from the J2 connector of the lower PCA.
8. The following voltage reading must be taken while the unit is in motion. Extreme care must be taken to keep meter leads, hands, etc. clear of all moving parts. Using a DC voltmeter, measure the voltage between TP13 (+5D) and TP4 (DGND). Refer to Diagram 6.4. The voltage measured should be approximately 5 Vdc. If the voltage is significantly low, replace the lower PCA. Additionally, the DS1 LED should illuminate.
9. Reconnect the interconnect cable to the J2 connector of the lower PCA and repeat the voltage measurement in step 8. The voltage measured should be approximately 5 Vdc. If the voltage is significantly low, the problem is in the upper PCA or the upper to lower PCA interconnect cables.

Diagram 6.4 - Partial View of Lower PCA

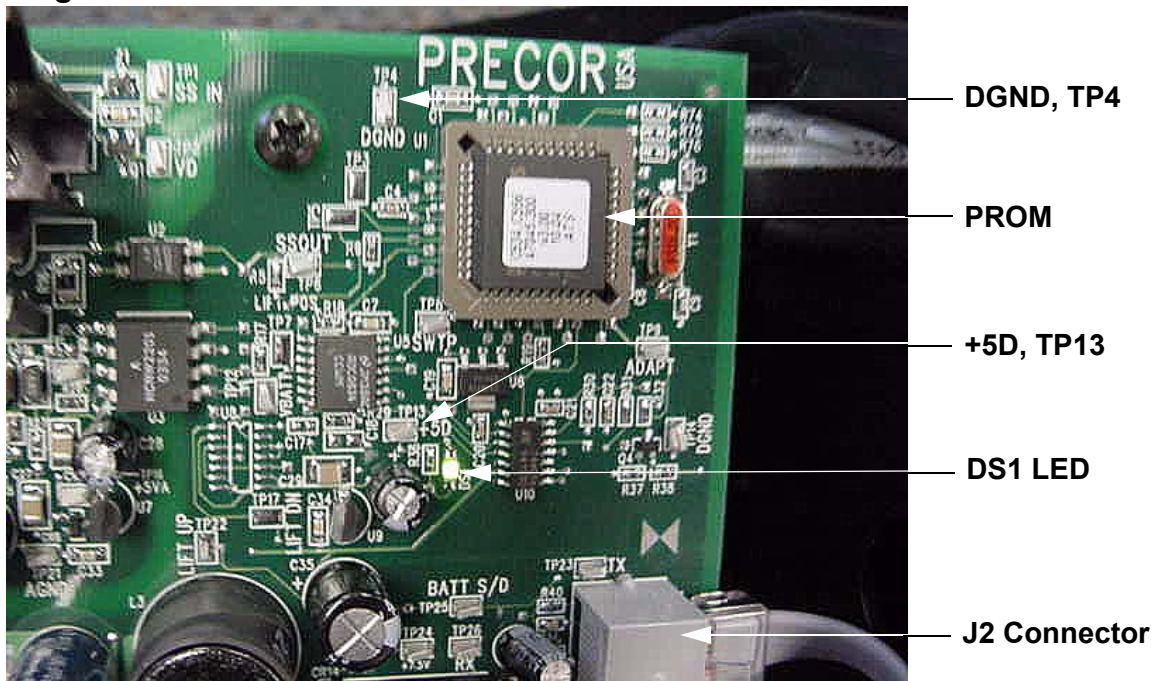

10. Troubleshoot the upper to lower PCA interconnect cables per Procedure 6.1.
11. If the upper to lower interconnect cables are found to be good, replace the upper PCA.
12. If you have performed all of the above tests and are unable to resolve the problem, contact Precor customer support.

Procedure 6.4 - Troubleshooting the Generator

The generator performs three functions in the EFX. First, by controlling the amount of electrical load applied to the generator, the user's pedalling resistance is controlled. Second, the generator is used to charge the EFX's internal battery. Lastly, one of the generator's six phase output windings is monitored to determine when the unit is in use and when it is idle. This system also determines the stride rate by determining the operating speed (output frequency) of the monitored generator winding.

Warning

Because this is a self powered unit, it will either be necessary to either equip the unit with the optional external power supply or have an assistant pedal on the unit while voltage measurements are being taken. Because of the danger of working on the unit while it is in motion using the optional external power supply is strongly recommended.

1. Perform the generator resistance test per Procedure 5.1. If any of the resistance measurements are significantly high or significantly low, replace the generator.
2. The following voltage readings must be taken while the unit is in motion. Extreme care must be taken to keep meter leads, hands, etc. clear of all moving parts. Using an AC voltmeter, measure the voltage between 1 & 3, 2 & 3, 5 & 7 and 6 & 7 on J1 of the lower PCA. All AC voltage readings will vary depending on the unit's stride rate at the time the measurement is taken. At a stride rate of 100 strides per minute, all three voltage readings will be approximately 100 VAC -110 VAC.
3. If any of the six readings in step 2 are significantly low, replace the generator.
4. If you have performed all of the above tests and are unable to resolve the problem, contact Precor customer support.

Procedure 6.5 - Troubleshooting Hand Held Heart Rate

Circuit Description

The hand held heart rate system is actually a dual system, that is, it can accept a heart rate signal from either the hand held heart rate contacts on the unit's handlebar or from a Polar heart rate chest strap transmitter. The heart rate system to operates the receiver with the chest strap heart rate priority. That is, if both a chest strap and hand heart rate signal is being received, the system will accept the chest strap signal and ignore the hand held signal. If a chest strap signal is not being received, the system will accept the hand held signal.

Note:

There are four typical failure modes for the hand held/chest strap heart rate system. They are: 1 - hand held is normal - no chest strap reading; 2 - no hand held reading - chest strap normal; 3 - no hand held or chest strap reading; 4 - constant or intermittent readings when neither hand held or chest strap are in use.

Diagram 6.5 - Hand held/chest strap heart rate PCA

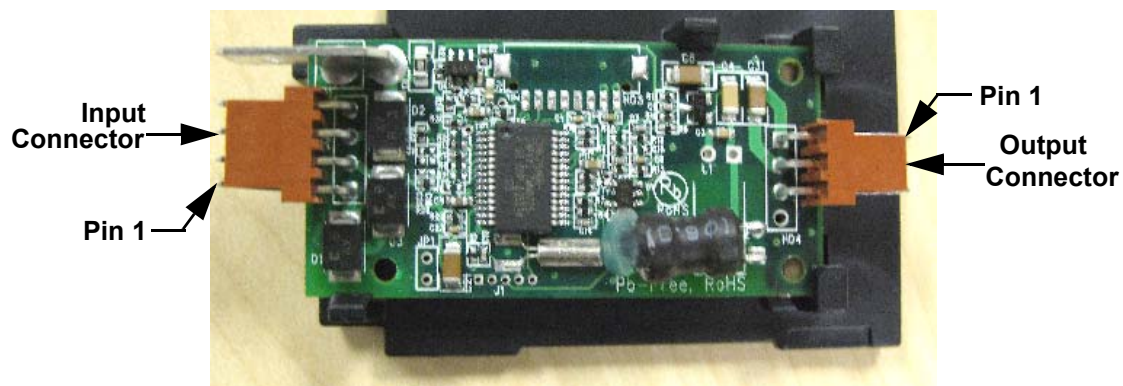

Normal hand held reading - No chest strap reading

1. Access the diagnostic program (Procedure 2.1). Advance to the heart rate display portion of the diagnostic program. Verify that a chest strap signal is not being accepted with either a Polar heart rate test transmitter or a known good chest strap transmitter. If this reading is not accepted, replace the heart rate pca.
2. Using a Polar heart rate test receiver, verify the operation of the chest strap transmitter furnished with the unit. If the Polar heart rate test receiver does not receive a signal, replace the chest strap transmitter.

No hand held reading - Normal chest strap reading

3. Access the diagnostic program (Procedure 2.1). Advance to the heart rate display portion of the diagnostic program. Verify that a hand held signal is not being accepted by firmly grasping both the right and left hand held contacts on the handlebars. Cover as much of the contact surface area with your hands as possible (without moving your hands), you should

receive a heart rate reading within ten seconds.

4. If a hand held signal is not being accepted, access the diagnostic program (Procedure 2.1). Advance to the heart rate display portion of the diagnostic program. Verify that a hand held signal is not being accepted by firmly grasping both the right and left hand held contacts with the opposite hands, right hand on the left handlebar contacts and left hand on the right handlebar contacts. Cover as much of the contact surface area with your hands as possible, you should receive a heart rate reading within ten seconds. If a hand held signal is still not being accepted, skip to step 9.
5. If a hand held signal was accepted in step 7, the hand held contact wiring is reversed. The end of the wire harness that connects to the hand held contacts in the handlebar is segregated into two groups. One group has blue shrink wrap around it and the other group has black shrink wrap around it. The "blue" group must go to the right hand contacts and the "black" group must go to the left hand contacts. In both groups the black wire must go to the lower contact and the red wire must go to the upper contact. If necessary, rewire the hand held contacts as described above and test as described in step 6.
6. Refer to Diagram 6.5 for the following measurements. With an ohmmeter measure between pin 4 of the input connector and the lower right hand held heart rate contact on the handlebar. The reading should be 1 Ω or less. Measure between pin 3 of the input connector and the upper right hand held heart rate contact on the handlebar. The reading should be 1 Ω or less. Measure between pin 2 of the input connector and the upper left hand held heart rate contact on the handlebar. The reading should be 1 Ω or less. Measure between pin 1 of the input connector and the lower left hand held heart rate contact on the handlebar. The reading should be 1 Ω or less. If any of the above readings are greater than 1 Ω , replace the heart rate PCA to handlebar wire harness.

No hand held reading - No chest strap reading

7. Access the diagnostic program (Procedure 2.1). Advance to the heart rate display portion of the diagnostic program. Verify that neither a chest strap signal or a hand held signal is being accepted with either a heart rate test transmitter or a chest strap transmitter.
8. Check the plug/connector connections on both the heart rate PCA output connector, and upper PCA (J1).
9. If neither a chest strap signal or a hand held signal is being accepted, measure between pin 1 and pin 2 of the output connector for 5 Vdc. If 5 Vdc is present, replace the heart rate PCA.
10. If 5 Vdc is not present, remove the output connector from the heart rate PCA. Measure between the pins 1 and 2 of the connector (just removed from the heart rate PCA) for 5 Vdc. If 5 Vdc is present, replace the heart rate PCA. If the 5 Vdc is not present, measure between the corresponding pins of J1 on the upper PCA (red and black wires). If 5 Vdc is not present replace the upper PCA. If 5 Vdc is present, replace the upper PCA to heart rate PCA cable.

Constant or intermittent readings when neither the hand held or chest strap is in use

11. Constant or intermittent heart rate readings when neither heart rate system is in use is caused by something in the near vicinity radiating RF energy that is being received by the chest strap portion of the heart rate PCA.
12. Grip the hand held heart rate contacts, if the hand held signal is now being accepted, something in the near vicinity is radiating RF energy that is being received by the chest strap portion of the heart rate PCA.
13. The source of the radiated energy must be determined and relocated so that it no longer affects the heart rate PCA. Televisions, cell phones, Cardio-theatre receivers, etc. are possible sources of radiated energy.

Procedure 6.6 - Troubleshooting the Incline System

The incline motor is a 12 Vdc motor with an internally driven 1 K Ω potentiometer used to track ramp position. Because the incline motor is a DC motor, incline motor direction is controlled by the polarity of the DC voltage applied to the incline motor. When a positive voltage is applied to the incline motor, the incline motor will move upward. When a negative voltage is applied to the incline motor, the incline motor will move downward. The incline motor is driven directly off of the battery, the generator and the external A.C. power supply only charge the battery. As the incline motor moves the 1 K Ω potentiometer is rotated via an internal gear drive system. The potentiometer's changing resistance is fed to the incline control system and converted to an A/D (analog to digital) reading that is used in the diagnostics system to indicate ramp position.

The ramp operating system has a battery monitoring system. If the battery voltage falls below 11 Vdc when ramp movement is initiated or the battery voltage falls below 10 Vdc after ramp movement has been initiated, ramp movement will be stopped and the message "**NO RAMP LOW VOLTAGE**" will be displayed. Ramp motion will not be enabled until such time as the battery voltage exceeds the above limits. The battery voltage must be raised to correct this condition either by battery charging or battery replacement. This is strictly a battery problem and not a incline system or incline motor problem.

1. If an Error 40 (no incline movement) is being displayed continue with step 2. If an Error 42 is being displayed (incline out of range) skip to step 12.

No Incline Movement

2. If the incline moves briefly and then displays an Error 40, skip to step 12. If the incline does not move prior to displaying the Error 40 continue with step 3.
3. Remove the rear cover. Remove the F1 fuse (6.3 amps) from the lower PCA. Check the fuses resistance using an ohmmeter. The fuse should read 1 Ω or less. If the reading is significantly high, replace the fuse. If the fuse is good or replacing the fuse does not correct the problem, continue with step 4.
4. Enter the hardware validation program per Procedure 2.1. Connect a DC volt meter to the J3 connector on the lower PCA as follows: voltmeter common lead to terminal 3 (black wire) and voltmeter "hot" lead to terminal 2 (red wire). Using the **CROSSRAMP** \blacktriangledown , \blacktriangle keys operate the incline. The voltmeter should read +12 Vdc when the incline is instructed to move upward and -12 Vdc when the incline is instructed to move downward.
5. If the **CROSSRAMP** \blacktriangledown , \blacktriangle keys are pressed, and the display does not indicate that the incline should be moving, troubleshoot the upper PCA and keypad per Procedure 6.2.
6. If the voltage measurements in step 4 are correct continue with step 7. If either voltage measurement in step 4 is significantly low, replace the lower PCA.
7. Verify that all of the wires in the intermediate cable (the cable inserted into J3 of the lower PCA) are securely inserted into the connector housing and providing a good electrical connection.

8. Remove both front covers. Enter the hardware validation program, if necessary, per Procedure 2.1. Connect a DC volt meter to the incline motor cable as follows: voltmeter common lead to terminal 2 (brown wire) and voltmeter “hot” lead to terminal 3 (red wire). Using the **CROSSRAMP** ▼,▲ keys operate the incline. The voltmeter should read +12 Vdc when the incline is instructed to move upward and -12 Vdc when the incline is instructed to move downward.
9. If the voltage measurements in step 8 are correct replace the incline motor. If either voltage measurement in step 4 is significantly low, continue with step 10.
10. Verify that all of the wires in the intermediate cable (the cable inserted into J3 of the lower PCA) are securely inserted into the connector housing and providing a good electrical connection.
11. If you have performed all of the above tests and are unable to resolve the problem, contact Precor customer support

Incline Out of Range

12. Enter the hardware validation program per Procedure 2.1 and advance to the **Lift Test**. If the A/D reading is either 0 or 255, skip to step 15.
13. Using the **CROSSRAMP** ▼,▲ keys operate the incline. If the A/D reading tracks the incline movement smoothly without skips, calibrate the incline motor per Procedure 5.3 and re-test incline functions in a normal operating mode.
14. If the A/D reading was erratic and did not smoothly follow incline motion, visually check the connections between the intermediate cable and the J3 connector on the lower PCA and between the intermediate cable.
15. Exit the hardware validation program, and leave the unit idle long enough for it to “shut off”. Disconnect the red battery lead from terminal M6 of the lower PCA. Remove the intermediate cable from the J3 connector of the lower PCA. Using an ohmmeter, test between terminal 4 (green wire) and terminal 6 (brown wire) of the intermediate cable. The ohmmeter should read approximately 1000Ω.
16. Test between terminal 4 (green wire) and terminal 5 (black wire) of the intermediate cable and between terminal 5 (black wire) and terminal 6 (brown wire) of the intermediate cable. These two readings should total approximately 1000Ω.
17. If the readings in steps 15 and 16 are correct, skip to step 19. If either reading is significantly high or low, continue with step 18.
18. Disconnect the intermediate cable from the incline motor cable. Using an ohmmeter read each of the six wires in the intermediate cable from end to end. Each of the wires in the intermediate cable should read less than 1Ω. If any of the readings are significantly high, replace the intermediate cable. If all of the readings are correct, continue with step 19.
19. Replace the incline motor. Calibrate the incline motor per Procedure 5.3.

Procedure 7.1 - Replacing or Removing a Rear Cover Section

Warning: Care must be taken when work is being performed in the area of the stairarms. Pinch points exist between the stairarm and ramp and between the stairarm and crankarm, when the rear covers are removed.

Procedure

WARNING

Before continuing with this procedure, review the Warning and Caution statements listed in Section One, Things You Should Know.

1. This procedure details the removal and replacement of the entire rear cover assembly. It is only necessary to perform the portion of this procedure that is required to access the particular section or sections that you are servicing.

Removal

2. Reach inside one of the stairarm slots in the front portion of the rear cover and locate one of the release points shown in Diagram 7.1. Gently, press upwards on the release point to unsnap the access panel from the rear cover. Grasp the raised edge of the access panel and remove it from the rear cover assembly.

Diagram 7.1 - Rear Cover Access Panel

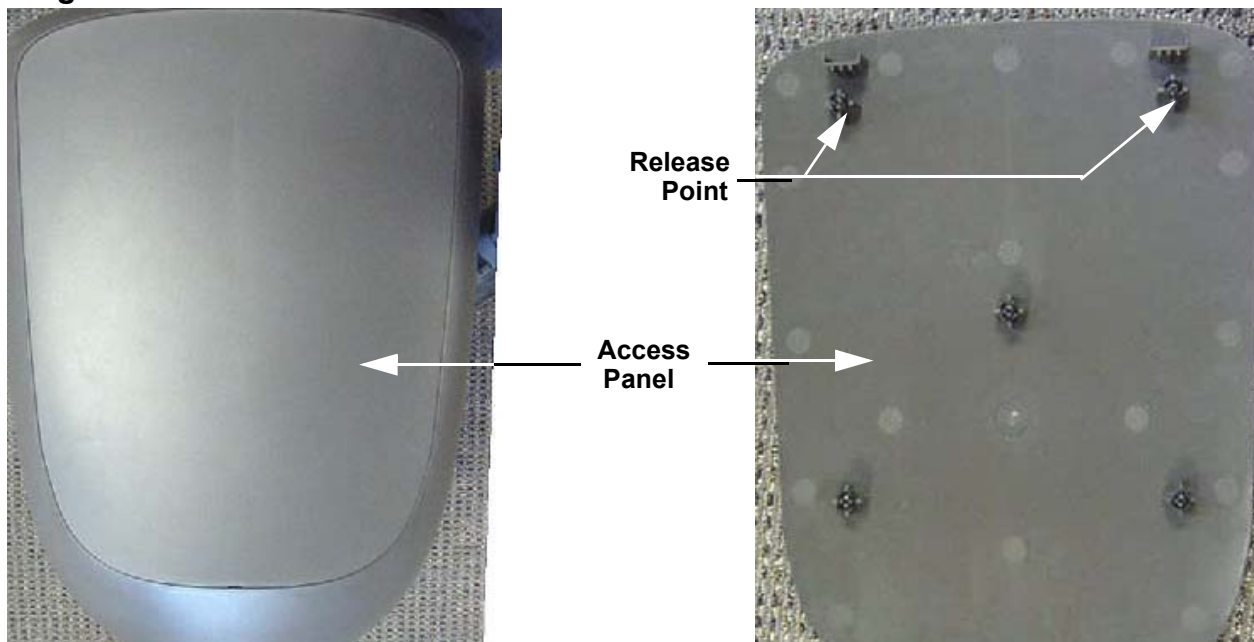

3. Remove the two screws in the rear of the cover assembly and the mounting screw shown in Diagram 7.2. Carefully pry the two snaps, shown in Diagram 7.2, toward the rear and remove the top cover.
4. Remove the left and right covers from the cover assembly.

Diagram 7.2 - Rear Cover assembly with the Access Panel Removed

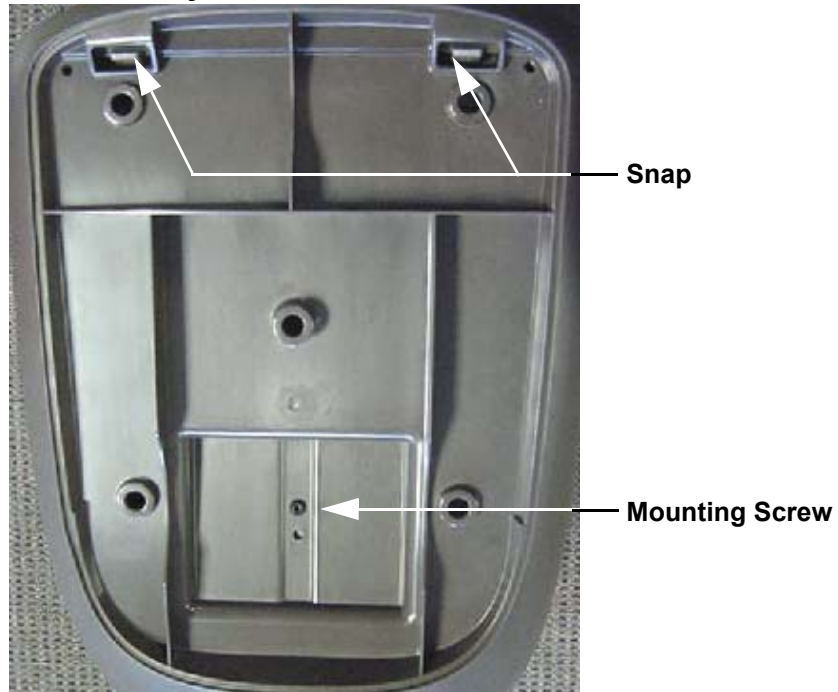

5. Remove the two screws that fasten the wedge cover to the frame and remove the wedge cover. See Diagram 7.3.

Diagram 7.3 - Wedge Cover



6. Remove the screws that fasten the lower PCA to the front cover section. Do not remove any of the wires or cables from the lower PCA.
7. Remove the three screws (one front and two rear) that fasten the front cover section to the frame. See Diagram 7.4.

Diagram 7.4 - Bottom and Front Cover Sections

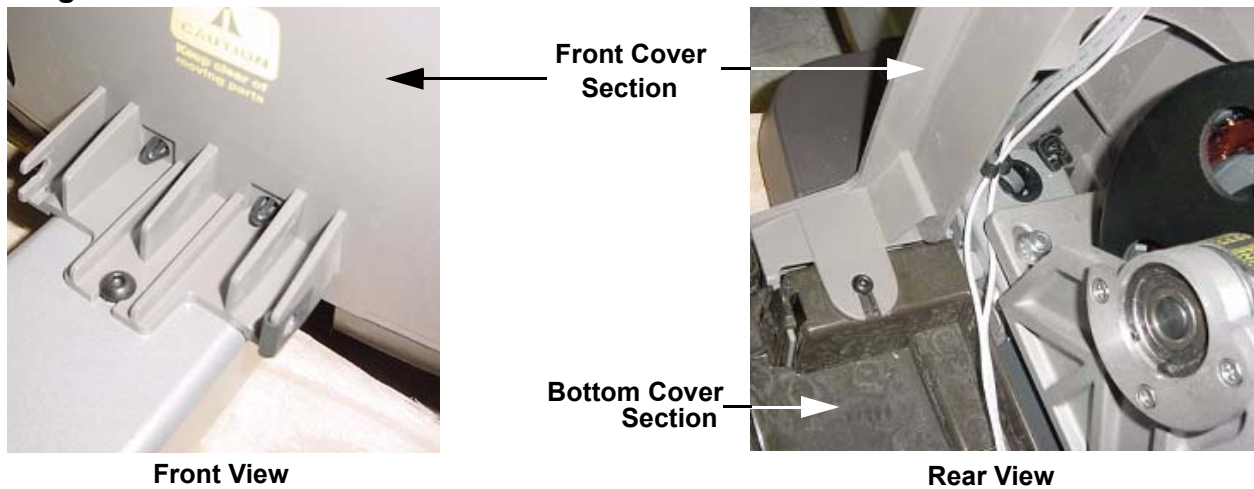

8. Remove the four screws that fasten the bottom cover section to the frame. Unsnap the front cover section from the bottom cover section and remove the front and bottom cover sections.

Installation

9. Set the bottom cover section in its mounting position and fasten it with the screws removed in step 9
10. Snap the front cover in its mounting position on the bottom cover and fasten it with the screws removed in step 8, torque the screws to 6-9 inch pounds. Set the lower PCA in its mounting position and fasten it with the screws removed in step 7, torque the screws to 6-9 inch pounds. Re-install the cover on the lower PCA.
11. Set the wedge cover in its mounting position and fasten it with the screws removed in step 6., torque the screws to 6-9 inch pounds
12. Set the left and right cover sections in their mounting positions making sure that all of the tabs on the left and right cover are correctly aligned in the bottom cover section.
13. Set the top cover in its mounting position, and press it into the two snaps shown in Diagram 7.2. Fasten the top cover section with the three screws removed in step 4. Torque the screws to 6-9 inch pounds.
14. Place the access panel in its mounting position on the top cover and press it into place.

Procedure 7.2 - Replacing a Display Front Panel, Upper PCA, Heart Rate PCA or Metrics PCA

Procedure

The keyboard is part of the display housing front panel. If the keyboard is not functioning properly, replace the display housing front panel.

Removing the Display Housing Front Panel

WARNING

Before continuing with this procedure, review the Warning and Caution statements listed in Section One, Things You Should Know.

1. Attach an anti-static wrist strap to your arm, then connect the ground lead of the wrist strap to the frame of the EFX.
2. Remove the upper and lower bracket covers from the rear of the display.
3. Remove display top and the rear cover from the display. If you are only replacing the heart rate PCA, skip to step 13.
4. Disconnect the heart rate cable and the data cable from the rear of the upper PCA. See Diagram 6.2.
5. Release the six snaps that fasten the display face to the display, see Diagram 6.2. Lift the display face off of the display.

Removing and Replacing the Upper PCA

6. Disconnect the metrics PCA cable, the keypad cable and the D pad cable from the upper PCA. See Diagram 6.3.
7. Remove the upper PCA by carefully unsnapping it from its mounts on the display front panel and slide it out of the two holding clips.
8. Position the replacement upper PCA at its mounting location on the display housing front panel, slide it into the two holding clips and press it into place in its mounts on the display front panel.
9. Reconnect the metrics PCA cable, the keypad cable and the D pad cable. See Diagram 6.3.
10. Set the display face in its mounting position and reconnect the heart rate cable. Snap the display face onto the display, working from bottom to top.
11. Remove the ground lead of the wrist strap from the EFX frame, then remove the wrist strap from your arm.
12. Skip to step 24.

Removing and replacing the HR PCA

13. The HR PCA is located on the rear of the display, see Diagram 6.2.
14. Disconnect the HR input and output cables from the HR PCA.
15. Remove the HR PCA by carefully unsnapping it from its mounts on the display.
16. Position the replacement HR PCA at its mounting location on the display and press it into place in its mounts.
17. Reconnect the HR input and output cables to the HR PCA.
18. Skip to step 24.

Removing and replacing the Metrics PCA

19. Disconnect the metrics cable from the metrics PCA. See Diagram 6.3.
20. Remove the metrics PCA by carefully unsnapping it from its mounts on the display front panel.
21. Position the replacement metrics PCA at its mounting location on the display housing front panel and press it into place in its mounts on the display front panel.
22. Reconnect the metrics cable to the metrics PCA.
23. Position the display front panel on the display and snap it into place, working from the bottom to the top.
24. Reconnect the data cable to rear of the upper PCA. See Diagram 6.2.
25. Replace the display top. Set the display bracket covers in their mounting position and fasten them with the screws removed in step 3, torque the screws to 6-9 inch pounds.
26. Check operation as described in Section Four.

Procedure 7.3 - Replacing a Lower PCA

Warning: Care must be taken when work is being performed in the area of the stairarms. Pinch points exist between the stairarm and ramp and between the stairarm and crankarm, when the rear covers are removed.

Procedure

WARNING

Before continuing with this procedure, review the Warning and Caution statements listed in Section One, Things You Should Know.

1. Remove the access panel, top, left and right rear cover sections per Procedure 7.1.
2. Attach an antistatic wrist strap to your arm, then connect the ground lead of the wrist strap to the EFX frame ground or unpainted surface.
3. Disconnect the data cable, red and black battery wires, the load resistor wires and the generator cable from the lower PCA.
4. Remove the screws that secure the lower PCA to the front cover section. Remove the lower PCA.
5. Position the replacement lower PCA at its mounting position on the front cover section. Fasten the lower PCA with the screws removed in step 5, torque the screws to 6-9 inch pounds.
6. Reconnect the data cable (J2), the red battery wire to M6, the black battery wire to M7, the load resistor wires to M1 & M2 and the generator cable (J1).
7. Replace the left, right, top and access panel cover sections per Procedure 7.1.
8. Check operation as described in Section Four.

Procedure 7.4 - Replacing a Lower or Upper Data Cable

Procedure

Note: Before you install a new data cable, ensure that the data cable is defective. Refer to Procedure 6.1. The upper data cable is connected to the upper PCA at the rear of the display, and is then routed down the left outrigger tube. The upper data cable meets the lower data cable at the bottom of the left outrigger tube. The upper data cable is connected to the lower data cable via a coupler module. The lower data cable is routed through the frame from the bottom of the left outrigger tube to the lower PCA.

Replacing an Upper Data Cable

1. Remove the display bracket cover and the display rear cover and disconnect the data cable from the upper PCA. See Diagram 6.2.
2. Remove the three bolts that fasten the top, remove the four bolts that fasten the bottom and remove the clamp from the center of the left outrigger tube. See Diagram 6.1. Carefully slide the outrigger tube a short distance away from the frame to expose the data cable.
3. Disconnect the data cable, from the outrigger tube, from the mid-point connector module. Disconnect the other end of the data cable from the upper PCA.
4. Tape one end of the replacement data cable to the display end of the existing data cable. Carefully pull the existing upper data cable out of the hole in the frame, near the rear of the ramp, as you feed the replacement data cable into the upper end of the left outrigger tube. Stop when the replacement data cable appears out of the bottom of the outrigger tube.
5. Remove the tape fastening the two data cables and discard the old data cable.
6. Reconnect the data cable to the rear of the upper PCA and replace the display bracket cover.
7. Connect the data cable to the mid-point connector, place the cables and mid-point connector in the frame.
8. Skip to step 17.

Replacing the Lower Data Cable

9. Remove the access panel, top, left and right cover sections per Procedure 7.1.
10. Remove the display bracket cover.
11. Remove the three bolts that fasten the top, remove the four bolts that fasten the bottom and remove the clamp from the center of the left outrigger tube. See Diagram 6.1. Carefully slide the outrigger tube a short distance away from the frame to expose the data cable.

12. Disconnect the data cable, from the frame, from the mid-point connector module. Disconnect the other end of the data cable from the lower PCA.
13. Tape the replacement lower data cable to the lower PCA end of the existing data cable. Carefully pull the existing lower data cable out of the hole in the frame as you feed the replacement data cable into the frame. Stop when the replacement data cable appears out of the hole in the frame.
14. Remove the tape fastening the two data cables and discard the old data cable.
15. Reconnect the data cable to the lower PCA.
16. Connect the data cable to the mid-point connector, place the cables and mid-point connector in the frame.
17. Carefully, set the outrigger tube in its mounting position and fasten it with the bolts and clamp removed in step 11.
18. Replace the left, right, top and access panel rear cover sections per Procedure 7.1.
19. Check operation as described in Section Four.

Procedure 7.5 - Replacing a Crankarm Assembly

Warning: Care must be taken when work is being performed in the area of the stairarms. Pinch points exist between the stairarm and ramp and between the stairarm and crankarm, when the rear covers are removed.

WARNING

Before continuing with this procedure, review the Warning and Caution statements listed in Section One, Things You Should Know.

1. Remove the access panel, top, left and right cover sections as described in Procedure 7.1.
2. Remove the left and/or right stairarm assembly as described in Procedure 7.14.

Note:

Notice the position of the two crank arms. When the crankarms are replaced, they must be positioned so that they are 180 degrees opposing.

3. Remove the bolt that secures the crankarm to the input pulley shaft. It will be necessary to use a Pitman arm puller or 4" to 6" gear puller to remove the crankarm. Do not use a hammer or mallet to remove the crankarm.
4. If you are removing both crank arm assemblies, repeat Steps 3 and 4 for the second crankarm assembly.

Diagram 7.5 - Crankarm

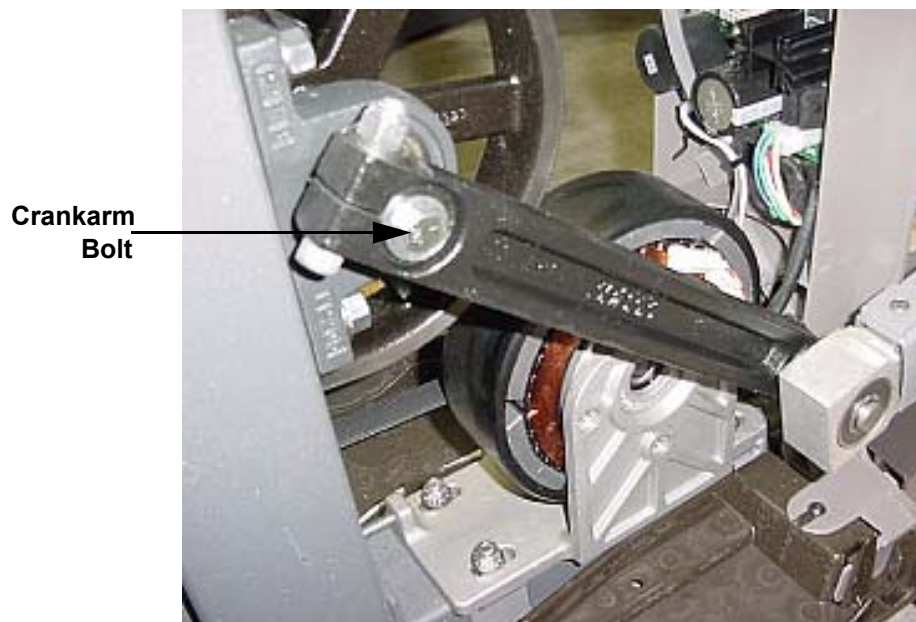

5. Clean the crankarm mounting bolt threads and the input pulley shaft threads with an alcohol swab. Allow them to dry and apply blue loctite to the crankarm mounting bolt threads.
6. Position the crankarm on the input pulley shaft. Thread and hand tighten the crankarm mounting bolt into the input pulley shaft. Torque the bolt to 300 inch pounds (25 foot pounds).
7. Replace the stairarm assembly as described in Procedure 7.14.
8. If you are replacing both crankarm assemblies, repeat steps 6, 7 and 8 for the second crankarm assembly.
9. Set the unit at it's highest resistance setting and use the EFX for a minimum of 3 minutes. Stride in a forward direction for half of the time and in a backward direction for half of the time. Re-torque both of the crankarm mounting bolts to 300 inch pounds (25 foot pounds).
10. Replace the left, right, top and access panel cover sections per Procedure 7.1.

Procedure 7.6 - Replacing the Input Pulley Belt

WARNING

Before continuing with this procedure, review the Warning and Caution statements listed in Section One, Things You Should Know.

1. Remove the access cover, top cover, left and right side rear covers per Procedure 7.1.
2. Remove the stairarm assemblies as described in Procedure 7.14.
3. Remove the crankarm assemblies as described in Procedure 7.5.
4. Remove the input pulley assembly per Procedure 7.8.
5. Remove the left and right tension bolts, locking tabs and brackets from the step up pulley assembly. Remove the generator belt from the generator's pulley, per Procedure 7.7.
6. Slide the step up pulley assembly with both the generator and input pulley belts out of the drive unit.
7. Remove the input pulley belt. Set the replacement input pulley belt in its mounting position on the step up pulley assembly.
8. Set the step up pulley assembly with the generator and input belt at its mounting position in the drive unit. Replace the tensioning bolts, locking tabs and brackets removed in step 6. Thread, but do not tighten, the left and right tension bolts into the step up pulley shaft.
9. Place the other end of the generator belt on the generator's pulley.
10. Place the other end of the input pulley belt on the input pulley assembly and mount the input assembly per Procedure 7.8
11. Replace the crankarm assemblies per Procedure 7.5.
12. Replace the stairarm assemblies per Procedure 7.14
13. Tension both belts per Procedure 5.2. Note the differences between tensioning a new belt and a existing (used) belt.
14. Check the operation of the EFX as described in Section Four.

Procedure 7.7 - Replacing the Generator Pulley Belt

WARNING

Before continuing with this procedure, review the Warning and Caution statements listed in Section One, Things You Should Know.

1. Remove the left and right side rear covers per Procedure 7.1.
2. Remove the stairarm assemblies as described in Procedure 7.14
3. Remove the crankarm assemblies as described in Procedure 7.5.
4. Remove the input pulley assembly per Procedure 7.8
5. Remove both tension bolts, locking tabs and brackets from the step up pulley assembly.
6. Remove the three bearing clamp screws shown in Diagram 7.8.
7. Remove the three generator mounting screws shown in Diagram 7.7.
8. Move the drive belt out of the way and slide the generator toward the side of the EFX. Lift the generator out of its bracket and remove its drive belt.
9. Slide the step up pulley assembly with the generator and input belts out of the drive unit.
10. Remove the generator belt. Set the replacement generator belt in its mounting position on the step up pulley assembly.
11. Set the step up pulley assembly with the generator and input belt at its mounting position in the drive unit. Replace the tensioning bolts, locking tabs and bracket removed in step 6. Thread, but do not tighten, the left and right tension bolts into the step up pulley shaft.
12. Lift the generator and place the drive belt around the generator's pulley. Position and slide the pulley side bearing into the generator bracket.
13. Replace and tighten the three generator mounting screws removed in step 7. Set the bearing clamp in its mounting position, replace and tighten the three bearing clamp mounting screws removed in step 6.
14. Mount the input assembly per Procedure 7.8.
15. Replace the crankarm assemblies per Procedure 7.5.
16. Replace the stairarm assemblies per Procedure 7.14.
17. Tension both belts per Procedure 5.2. Note the differences between tensioning a new belt and an existing (used) belt. Check the operation of the EFX as described in Section Four.

Procedure 7.8 - Replacing the Input Pulley Assembly

WARNING

Before continuing with this procedure, review the Warning and Caution statements listed in Section One, Things You Should Know.

1. Remove the left and right side rear covers per Procedure 7.1.
2. Remove the stairarm assemblies as described in Procedure 7.14.
3. Remove the crankarm assemblies as described in Procedure 7.5
4. Remove the input pulley assembly mounting nuts (2 per pillow block bearing).
5. Straighten the locking tabs and turn the left and right tension bolts counterclockwise until tension is removed from the both belts. (Refer to Diagram 5.2)

Diagram 7.6 - Input Pulley Assembly

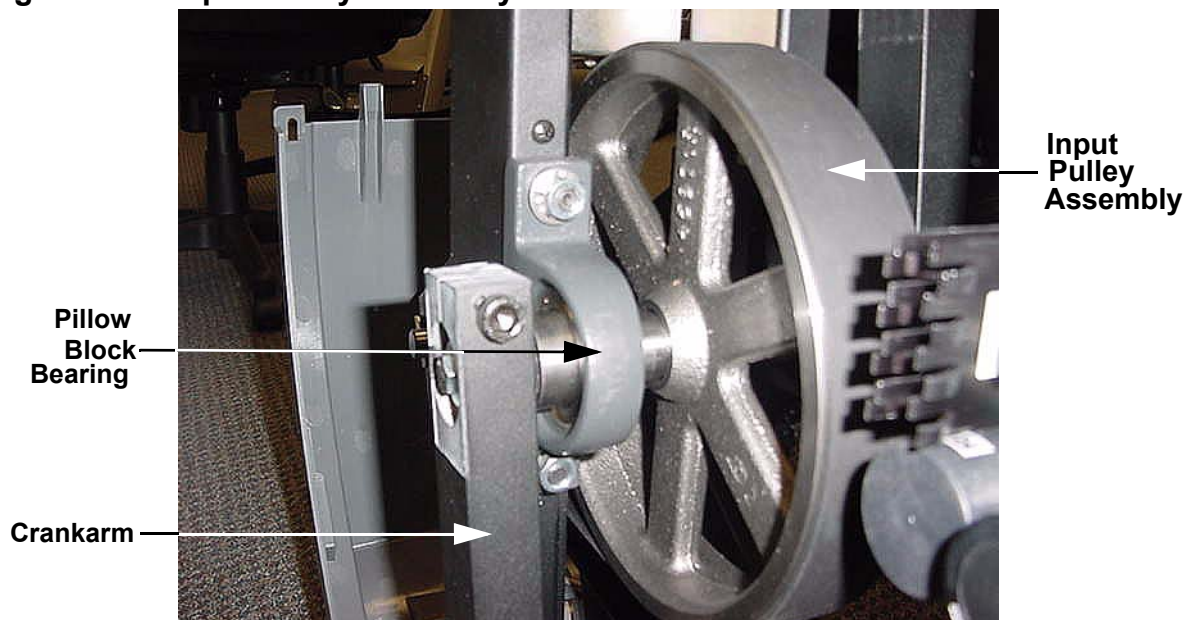

6. Remove the input pulley assembly. Slide input pulley belt off of the input pulley assembly.
7. Hold the replacement input pulley assembly at its mounting position and slide the input belt over and past the pillow block bearing and onto the input pulley assembly.
8. Replace the nuts on the pillow block bearings and torque them to 400 inch pounds.

9. Replace the crankarms per Procedure 7.5. The crankarms must be parallel to the frame uprights. Refer to Diagram 7.9. If necessary loosen the four drive unit mounting bolts, align the drive unit and torque the drive unit mounting bolts to 400 inch pounds.
10. Tension both belts per Procedure 5.2. Note the differences between tensioning a new belt and a existing (used) belt.
11. Replace the left and right side rear covers.

Procedure 7.9 - Replacing the Step-Up Pulley Assembly

WARNING

Before continuing with this procedure, review the Warning and Caution statements listed in Section One, Things You Should Know.

1. Remove the left and right side rear covers per Procedure 7.1.
2. Remove the stairarm assemblies as described in Procedure 7.14.
3. Remove the crankarm assemblies as described in Procedure 7.5.
4. Remove tension from the input pulley and generator belts as described below:
 - a. Straighten the locking tabs and turn the left and right tension bolts counterclockwise until tension is removed from the both belts. (Refer to Diagram 5.2)
 - b. Remove both tension bolts and slide the input belt off of the step up pulley assembly.
5. Place the input belt and step up belt in place on the replacement step up pulley. Set other end of the generator belt on the generator pulley.
6. Replace the tension bolts and associated hardware removed in step 4b.
7. Tension both belts per Procedure 5.2. Note the differences between tensioning a new belt and a existing (used) belt.
8. Replace the crankarms per Procedure 7.5.
9. Replace the stairarm assemblies removed in step 2 per Procedure 7.14.
10. Replace the left and right side rear covers.

Procedure 7.10 - Replacing a Generator

WARNING

When the unit is used, stairarms are in motion or the generator is rotated by any means, the generator will produce potentially hazardous voltages even when the battery is disconnected.

1. Remove the rear cover and disconnect the red battery lead from terminal M6 of the lower PCA.
2. Loosen all four generator mounting nuts. Loosen the locking nut on the generator's adjustment bolt and thread the adjustment bolt into tab to remove tension from the generator's drive belt.
3. Remove the three generator mounting screws shown in Diagram 7.7.
4. Remove the three bearing clamp screws shown in Diagram 7.8.
5. Slide the generator toward the side of the EFX and lift the generator and remove its drive belt.
6. Remove the four generator mounting nuts. Disconnect the generator's cable connector from the intermediate cable and remove the generator from the EFX.
7. Remove the adjustment bolt and its locking nut from the generator's mounting base.
8. Thread the adjustment bolt and locking nut into the tab on the replacement generator.

Diagram 7.7 - Generator Mounting



9. Set the replacement generator at its mounting position. Remove the three generator mounting screws, the three bearing clamp screws and the bearing clamp. Lift the generator and place the drive belt around the generator's pulley.

Diagram 7.8 - Generator Mounting, Pulley Side



10. Replace and tighten the three generator mounting screws removed in step 9. Set the bearing clamp in its mounting position, replace and tighten the three bearing clamp mounting screws removed in step 9.
11. Hand start, but do not tighten the four mounting nuts removed in step 6. The generator must be able to move in order to adjust the belt tension.
12. Adjust the generator drive belt tension per Procedure 5.3.
13. Reconnect the red battery lead removed in step 1 and replace the rear cover.
14. Check the operation of the EFX as described in Section Four.

Procedure 7.11 - Replacing a Battery

1. Remove the access cover, top cover, left and right side covers per Procedure 7.1.
2. Disconnect the red wire from the positive terminal of the battery and the black wire from the negative terminal of the battery.
3. Remove the nut that fastens the battery bracket tab and remove the battery bracket tab. See Diagram 7.9.

Diagram 7.9 - Battery Mounting

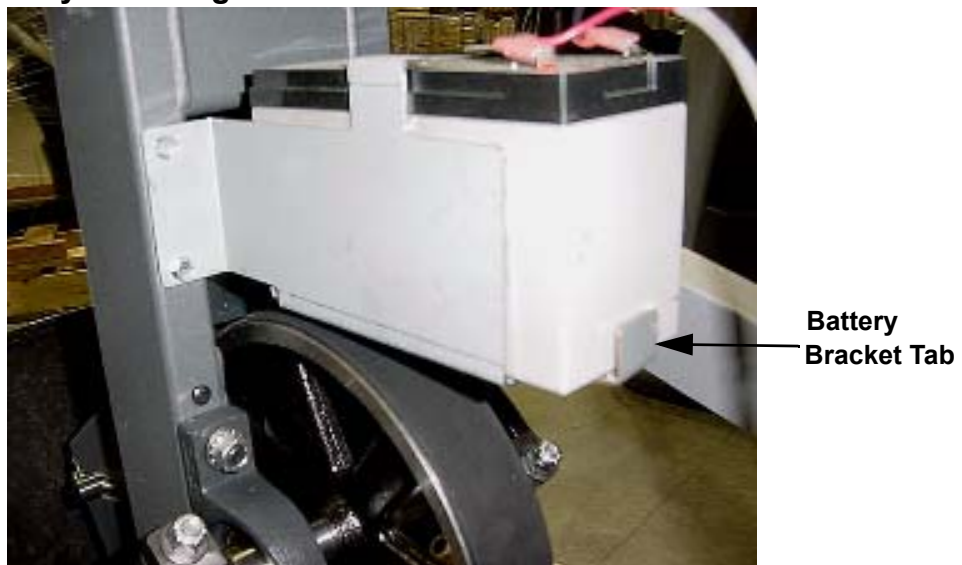

4. Slide the old battery out of its mounting bracket.
5. Slide the replacement battery into the battery mounting bracket.
6. Replace the battery bracket tab and fasten it with the nut removed in step 3.
7. Connect the black wire, removed in step 2, to the negative battery terminal. Connect the red wire, removed in step 2, to the positive battery terminal.
8. Check the operation of the EFX as described in Section Four.

Procedure 7.12 - Replacing a Wheel Assembly

Warning: Care must be taken when work is being performed in the area of the stairarms. Pinch points exist between the stairarm and ramp and between the stairarm and crankarm, when the rear covers are removed.

Procedure

WARNING

Before continuing with this procedure, review the Warning and Caution statements listed in Section One, Things You Should Know.

1. Remove the access, top, left and right cover sections as described in Procedure 7.1
2. If the moveable arm's connecting link is attached to the stairarm, remove it from the stairarm.
3. Remove the stairarm pivot block retaining ring, flat washer and wave washer from the crankarm pin. See Diagram 7.10
4. Remove the stairarm from the crankarm and roll the stairarm off of the rear of the ramp.

Diagram 7.10- Wheel Assembly



5. Remove the screws that fasten the two retainers to the stairarm. Remove the wheel and discard.
6. Set the replacement wheel in its mounting position and fasten it with the retainers and screws removed in step 5. Torque the screws to 60 inch pounds.

7. Roll the stairarm into the ramp channel from the rear of the ramp. Slide the stairarm pivot block onto the crankarm pin and replace the wave washer, flat washer and retaining ring removed in step 3.
8. Replace the left, right, top and access panel cover sections per Procedure 7.1.

Procedure 7.13 - Replacing a Stairarm Pedal

Warning: Care must be taken when work is being performed in the area of the stairarms. Pinch points exist between the stairarm and ramp and between the stairarm and crankarm, when the rear covers are removed.

1. Remove the four palnuts that fasten the pedal to the stairarm. Remove the pedal from the stairarm. There are two strips of double sided tape between the pedal and the stairarm, so there will be some resistance when you remove the pedal.
2. Remove the two strips of double sided tape and replace them with two new strips of double sided foam tape, Precor part number 39874-101.

Diagram 7.11 - Stairarm Pedal, Viewed from the Bottom of the Stairarm

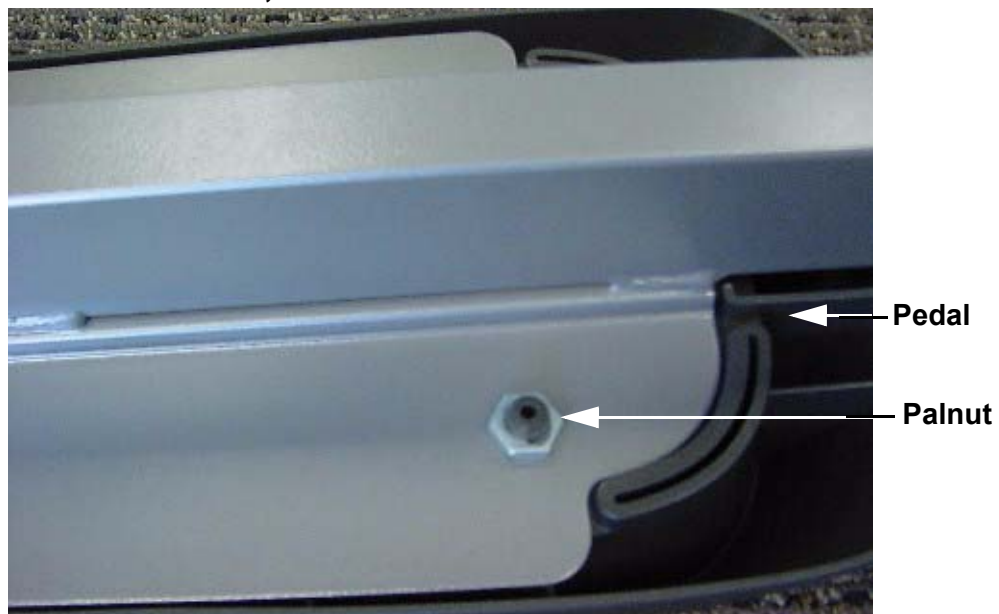

3. Set the pedal in its mounting position on the stairarm and fasten it with the four palnuts removed in step 2. The palnuts will cut new threads in the pedals plastic studs. Torque the palnuts to 6-9 inch pounds.

Procedure 7.14 - Replacing a Stairarm

Warning: Care must be taken when work is being performed in the area of the stairarms. Pinch points exist between the stairarm and ramp and between the stairarm and crankarm, when the rear covers are removed.

1. Remove the access panel, top, left and right cover sections as described in Procedure 7.1.
2. If the moveable arm's connecting link is attached to the stairarm, remove it from the stairarm.
3. Remove the snap ring that fastens the stairarm to the crankarm. Slide the stairarm off of the crankarm, and leave the wave washer on the crankarm.
4. Roll the stairarm out of the rear of the ramp.
5. Remove the stairarm pedal from the existing stairarm and install it on the replacement stairarm per Procedure 7.13.
6. Remove the stairarm wheel from the existing stairarm and install it on the replacement stairarm per Procedure 7.12
7. Roll the stairarm into the ramp channel from the rear of the ramp.
8. Slide the stairarm onto the crankarm and secure it with the snap ring removed in step 3.
9. If the moveable arm's connecting link was moved from the stairarm, re-install the connecting link on the stairarm.
10. Replace the left, right, top and access panel cover sections per Procedure 7.1.

Procedure 7.15 - Replacing a Ramp Assembly

Warning: Care must be taken when work is being performed in the area of the stairarms. Pinch points exist between the stairarm and ramp and between the stairarm and crankarm, when the rear covers are removed.

1. Pedal the EFX and press the **QUICK START** key, while striding on the unit raise the incline to its maximum position.
2. Remove the access panel, top, right and left rear covers per Procedure 7.1
3. Remove both stairarms per Procedure 7.14.
4. Remove the two bolts that fasten the lower rear portion of the ramp to the frame. See Diagram 7.11.

Diagram 7.11 - Lower Ramp Mounting

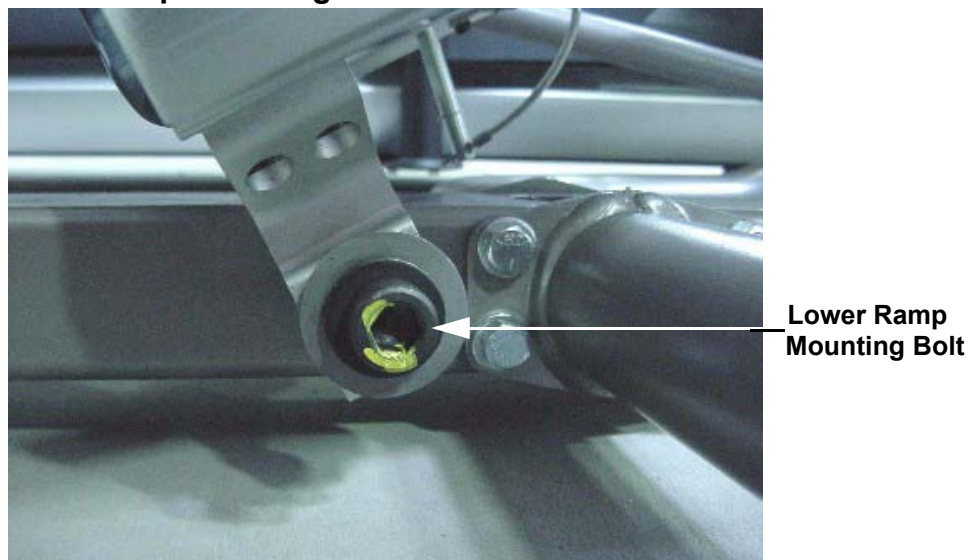

5. Remove the two bolts that fasten the upper end of the ramp to the lift motor yoke. See Diagram 7.12.
6. Carefully lift the ramp and slide it off of the lift motor yoke.
7. Slide the replacement ramp onto the lift motor yoke and hand. Hand start the two lower ramp mounting bolts removed in step 5. Fasten the upper end of the ramp to the lift motor yoke with the hardware removed in step 6. Install and torque the two lower ramp bolts to 480 inch pounds (40 foot pounds).

Diagram 7.12 - Upper Ramp Mounting

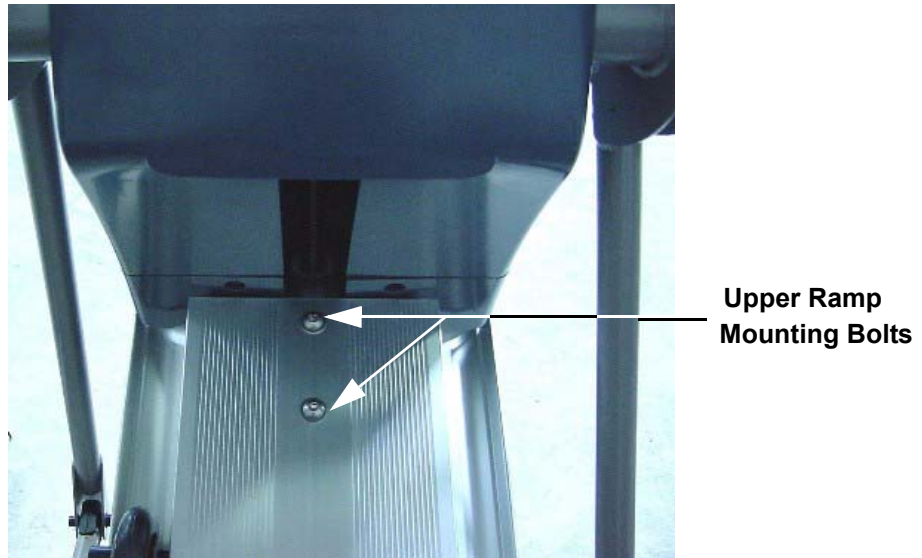

8. Replace both stairarms per Procedure 7.11.
9. Replace the left, right, top and access panel cover sections per Procedure 7.1.

Procedure 7.16 - Replacing a Moveable Handlebar

1. Remove the bolt that fastens the forward end of the connecting link to the moveable handlebar. See Diagram 7.14

Diagram 7.14 - Moveable Handlebar, Lower End



2. Removing the connecting link prevents it from resting on the outrigger tube and will prevent the painted surfaces of the outrigger tube and connecting link from damage. Remove the connecting link mounting bolt and set the connecting link aside.

Diagram 7.15 - Handlebar Connecting Link

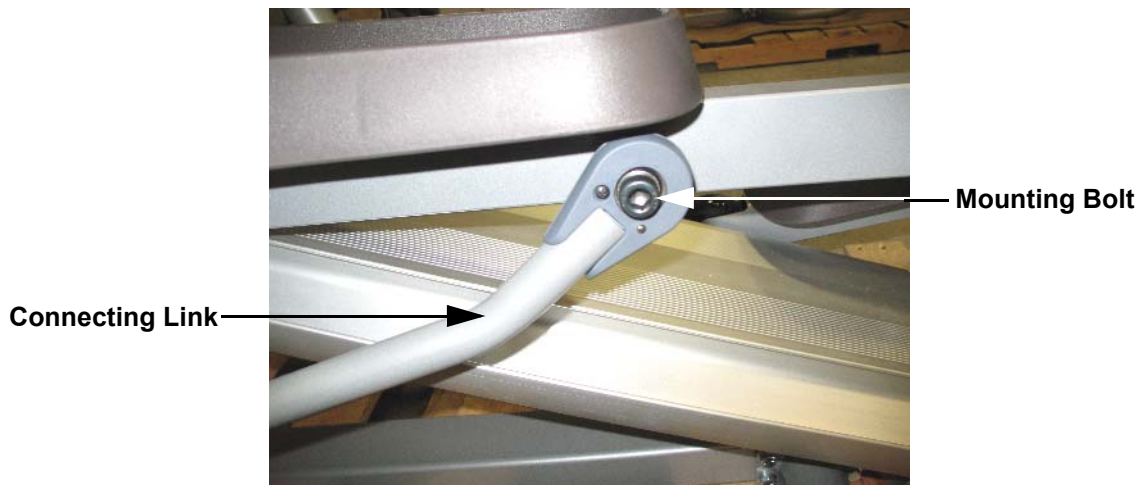

3. Remove the outrigger tube per Procedure 7.18.
4. Using a 1/2 inch wrench on the moveable handlebar's axle, unscrew and remove the moveable handlebar. See Diagram 7.16.

Diagram 7.16 - Moveable Handlebar

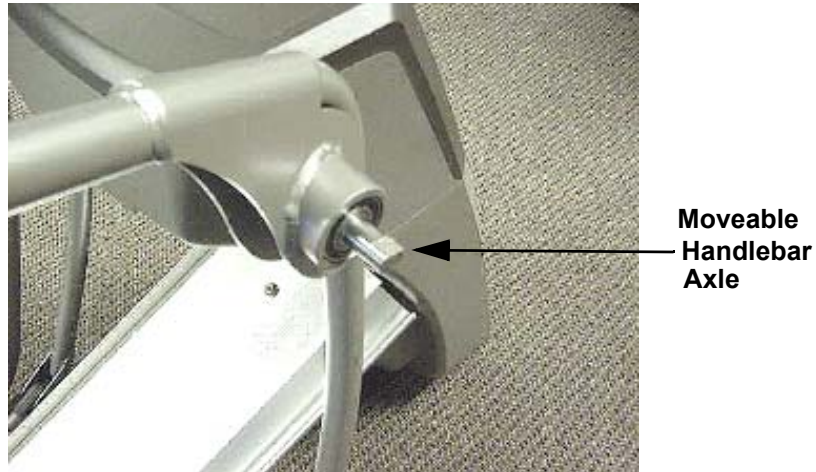

5. Set the replacement moveable handlebar in its mounting position. Carefully start hand threading the moveable handlebar to avoid cross threading and then tighten.
6. Replace the outrigger tube per Procedure 7.18.
7. Fasten the connecting link to the stairarm with the hardware removed on step 3, torque the bolt to 40 foot pounds (480 inch pounds).

Procedure 7.17 - Replacing a Front Cover Section

1. It is only necessary to perform as much of this procedure as is required to access the cover being replaced.
2. Grasp the upper front cover section and lift upwards to remove it. See Diagram 7.17

Diagram 7.17 - Front Covers

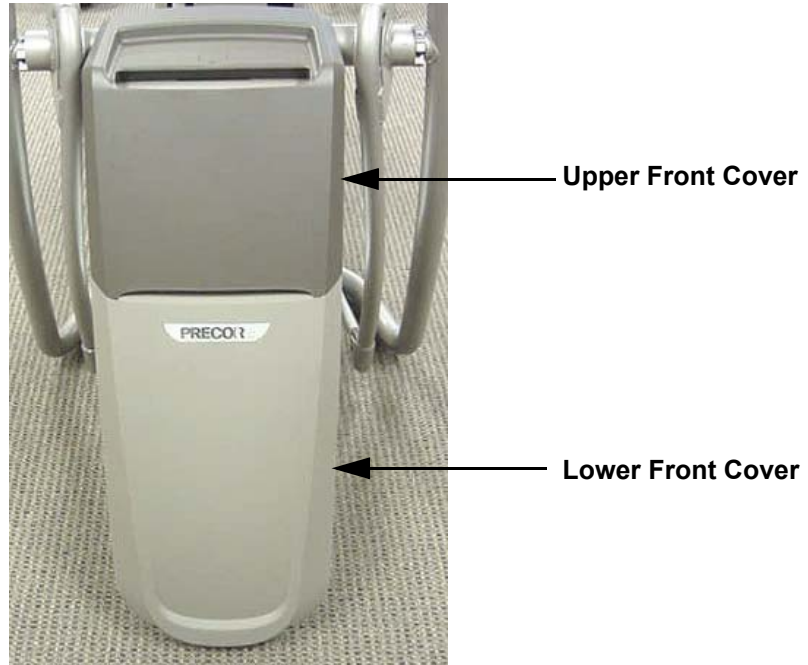

3. Remove the four screws that fasten the top cover section. See Diagram 7.18.

Diagram 7.18 - Top Cover with Upper Front Cover Removed

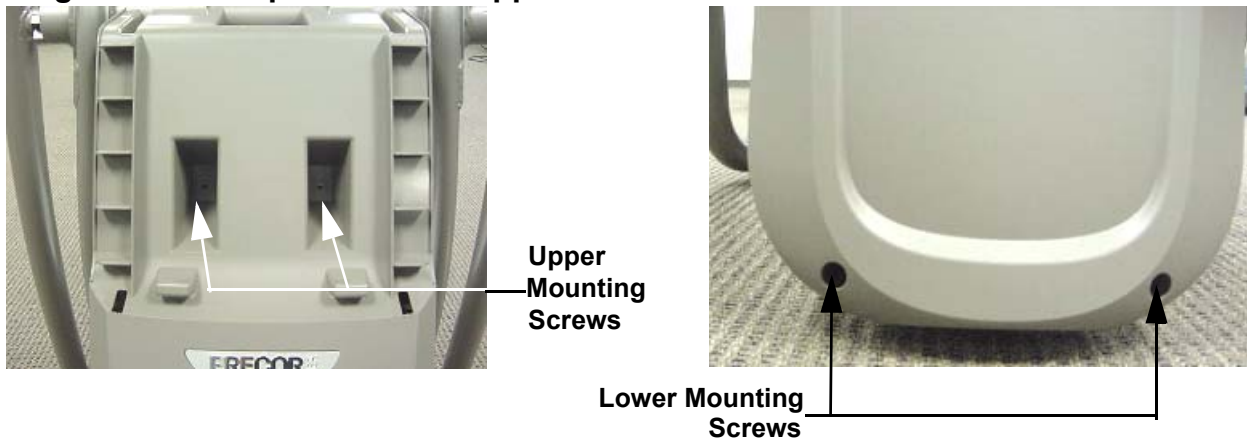

4. The lower rear cover must be removed before the upper rear cover.
5. Remove the two screws in the bottom of the lower rear cover. Slide the rear cover rearward and off of the EFX. See Diagram 7.19.

Diagram 7.19 - Lower Rear Cover, Rear View

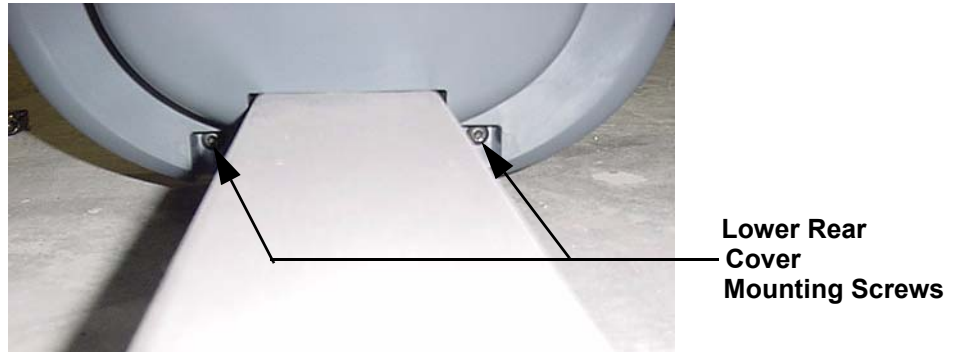

6. Lower the incline to its lowest position. Remove the two screws from the rear of the upper rear cover. See Diagram 7.20.

Diagram 7.20 - Upper Rear Cover, Rear View

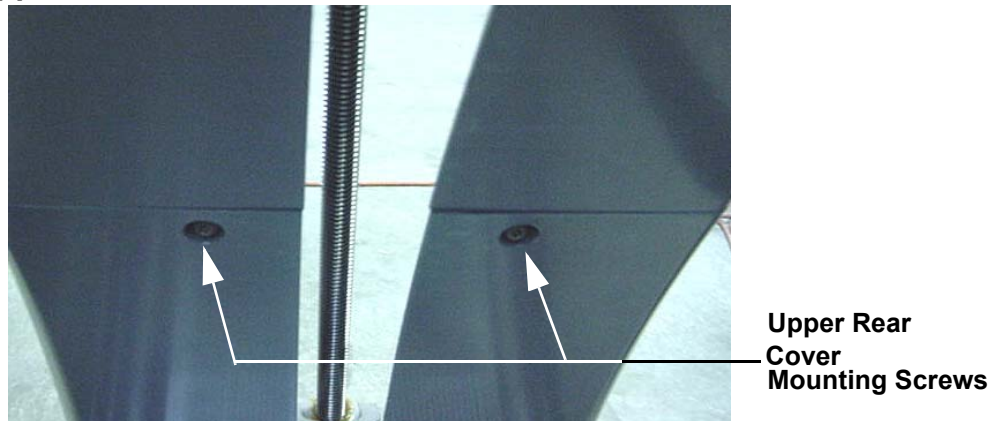

7. With the incline at its lowest position, set the upper rear cover in its mounting position and fasten it with the two screws removed in step 7.
8. Raise the incline to its highest position and set the lower rear cover in its mounting position and fasten it with the screws removed in step 6, torque the screws to 6-9 inch pounds.
9. Set the lower front cover in its mounting position ensuring that the tabs in the lower front cover align with the pockets in the lower and upper rear covers. Snap the front cover into place and fasten it with the screws removed in step 4, torque the screws to 6-9 inch pounds.
10. Set the upper front cover in its mounting position and snap it into place.

Procedure 7.18 - Replacing an Outrigger Tube

1. Remove the display bracket cover from the rear of the display.
2. Carefully, lift the front of the EFX and place it on a temporary support, such as a block of wood. This is necessary to remove the EFX's weight from the outrigger tube. Before proceeding with procedure, be sure that the EFX is in a solid stable position and will not tip or fall off of the temporary support.
3. Remove the three bolts from the upper end of the outrigger tube and four bolts from the lower end of the outrigger tube. See Diagram 7.21.

Diagram 7.21 - Outrigger Tube Mounting

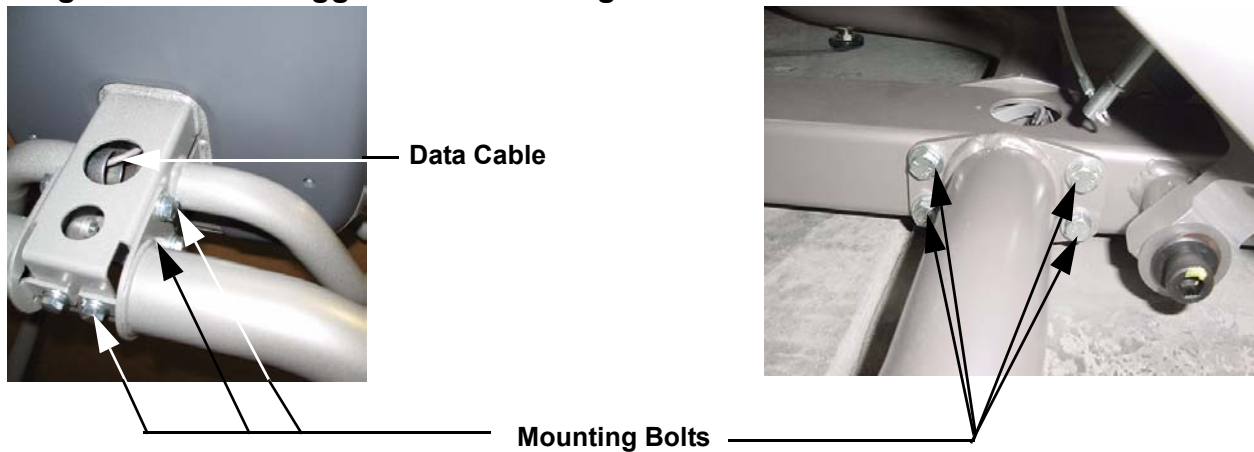

4. Loosen but do not remove the two clamp bolts at the handlebar pivot point. See Diagram 7.22.

Diagram 7.22 - Outrigger Tube Mounting

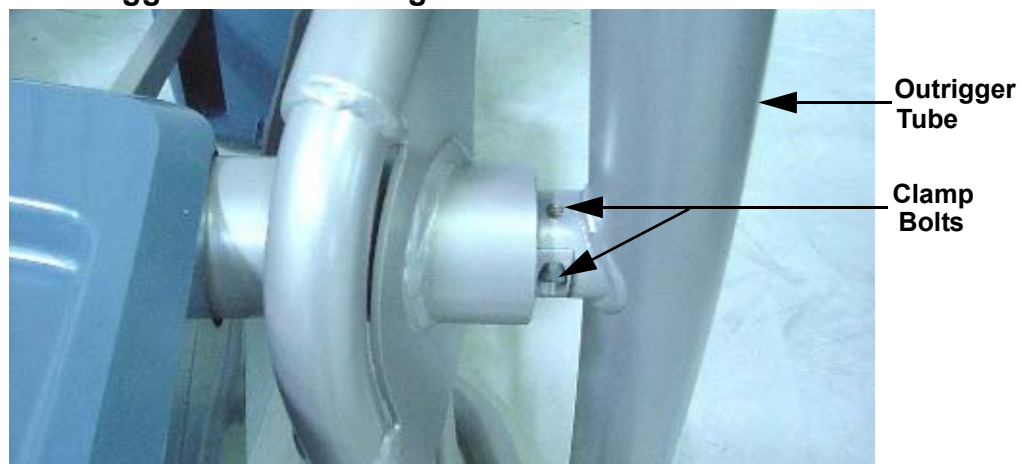

5. If you are removing the right hand outrigger tube, skip to step 12. If you are removing the left hand outrigger tube, continue with step 7.
6. Disconnect the data cable from the upper printed circuit board. If applicable. See Diagram 6.2.
7. Carefully remove the outrigger tube from the EFX. The data cable is still connected to the mid-point connector and the lower end of the outrigger tube.
8. Disconnect the data cable from the mid-point connector.
9. Remove the data cable from the old outrigger tube and feed it into the replacement outrigger tube.
10. Connect the data cable to the upper PCA and the mid-point connector.
11. Set the outrigger tube at its mounting position and fasten it with the seven bolts removed in step 4. Tighten the clamp bolts loosened in step 5.
12. Replace the display bracket cover with the hardware removed in step 2.
13. Thoroughly test the EFX per Section Four.

Procedure 7.19 - Replacing a Ramp Mounting Bracket

Warning: Care must be taken when work is being performed in the area of the stairarms. Pinch points exist between the stairarm and ramp and between the stairarm and crankarm, when the rear covers are removed.

Procedure

1. Raise the incline to its maximum position.
2. Place a support (such as a piece of wood) between the rear of the ramp and the frame. The support must fit snugly so that it will support the ramp when the ramp mounting bracket is removed. The support will also facilitate the mounting and alignment of the replacement ramp mounting bracket.
3. Remove the four screws that fasten the ramp mounting bracket to the ramp.

Diagram 7.23 - Ramp Mounting Bracket



4. Remove the two large bolts that fasten the ramp mounting bracket to the frame.
5. Set the ramp mounting bracket at its mounting position and fasten it to the frame with the hardware removed in step 5. Torque the bolts to 480 inch pounds (40 foot pounds).
6. Fasten the ramp mounting bracket to the ramp with the hardware removed in step 4, torque the screws to 144 inch pounds (12 foot pounds).
7. Remove the support from the rear of the ramp.
8. Thoroughly, test the EFX per Section Four.

Procedure 7.20 - Replacing a Lift Motor

1. Remove the upper and lower front covers per Procedure 7.17.
2. Remove the bolts that fasten the upper end of the ramp to the lift motor yoke.
3. Carefully, draw the lift motor yoke out of the ramp and lay the ramp down against the frame.
4. Disconnect the lift motor connector and remove the screw that retains the lift motor frame ground. See Diagram 7.24.

Diagram 7.24 - Lift Motor Mounting

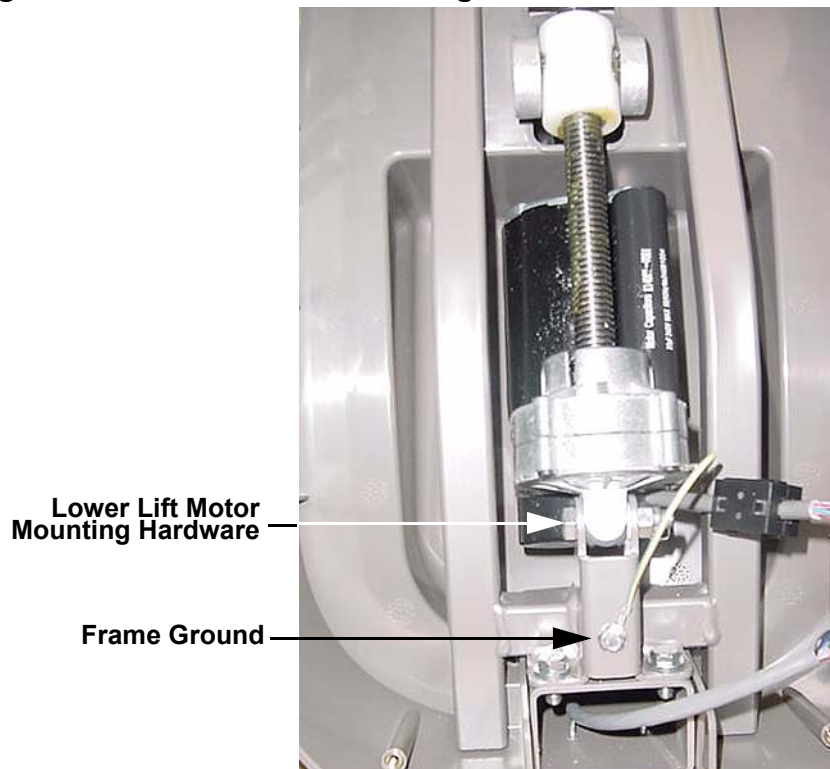

5. Disconnect the lift motor cable connector.
6. Remove the nut and bolt that fasten the lower end of the lift motor to the frame.
7. Thread the lift motor yoke onto the replacement lift motor.
8. Set the replacement lift motor in its mounting position and secure it with the nut and bolt removed in step 7, torque the bolt to 60 inch pounds.
9. Reconnect the lift motor cable connector. Fasten the frame ground connector to the frame with the screw removed in step 6, torque the frame ground screw to 90 inch pounds.
10. Calibrate the lift motor per Procedure 5.3.

11. Raise the ramp and slide the lift yoke into the ramp and fasten it with the hardware removed in step 3.
12. Replace the lower and upper front covers.
13. Thoroughly, test the EFX per Section Four.

Procedure 7.21 - Replacing the PROM

1. The PROM and the associated printed circuit assembly (PCA) are static sensitive. Anti-static devices must be used and all anti-static precautions must be followed during this procedure.
2. Remove the printed circuit assembly per its associated procedure.
3. The prom is a forty-four pin square package (PLCC44). This prom should be removed with a proper IC removal tool (see the illustration below)

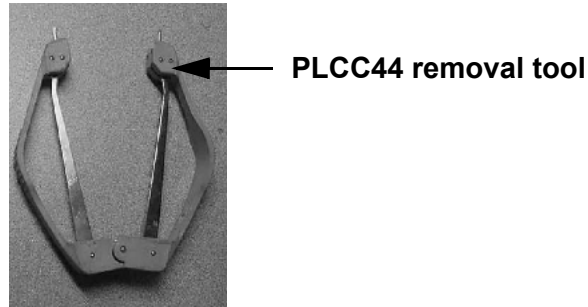

4. The IC's may inserted into their socket by hand by carefully aligning the notch on the IC with the notch on the IC socket and carefully pressing the IC into its socket. See the illustrations below for the alignment notches. Care must be taken that the IC legs on a DIP28 are all aligned in the socket to prevent the legs from bending when inserted. The PLCC44 IC must be carefully aligned squarely in its socket or it will not insert. Do not force the IC into its, socket. If it does not insert easily, remove the it and re-align it in its socket.

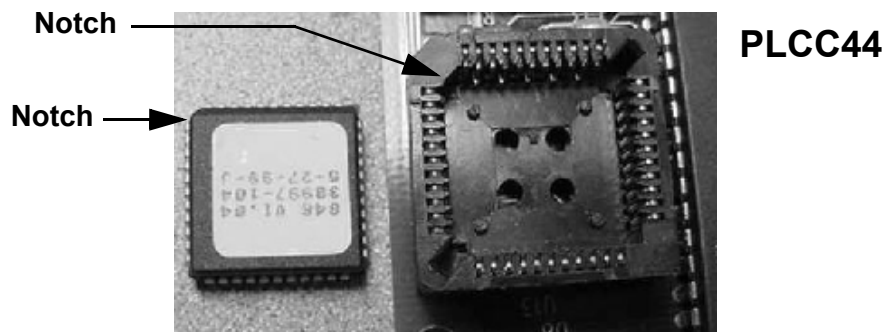

Wiring Diagram 8.1 - C532i, C556i Navy EFX

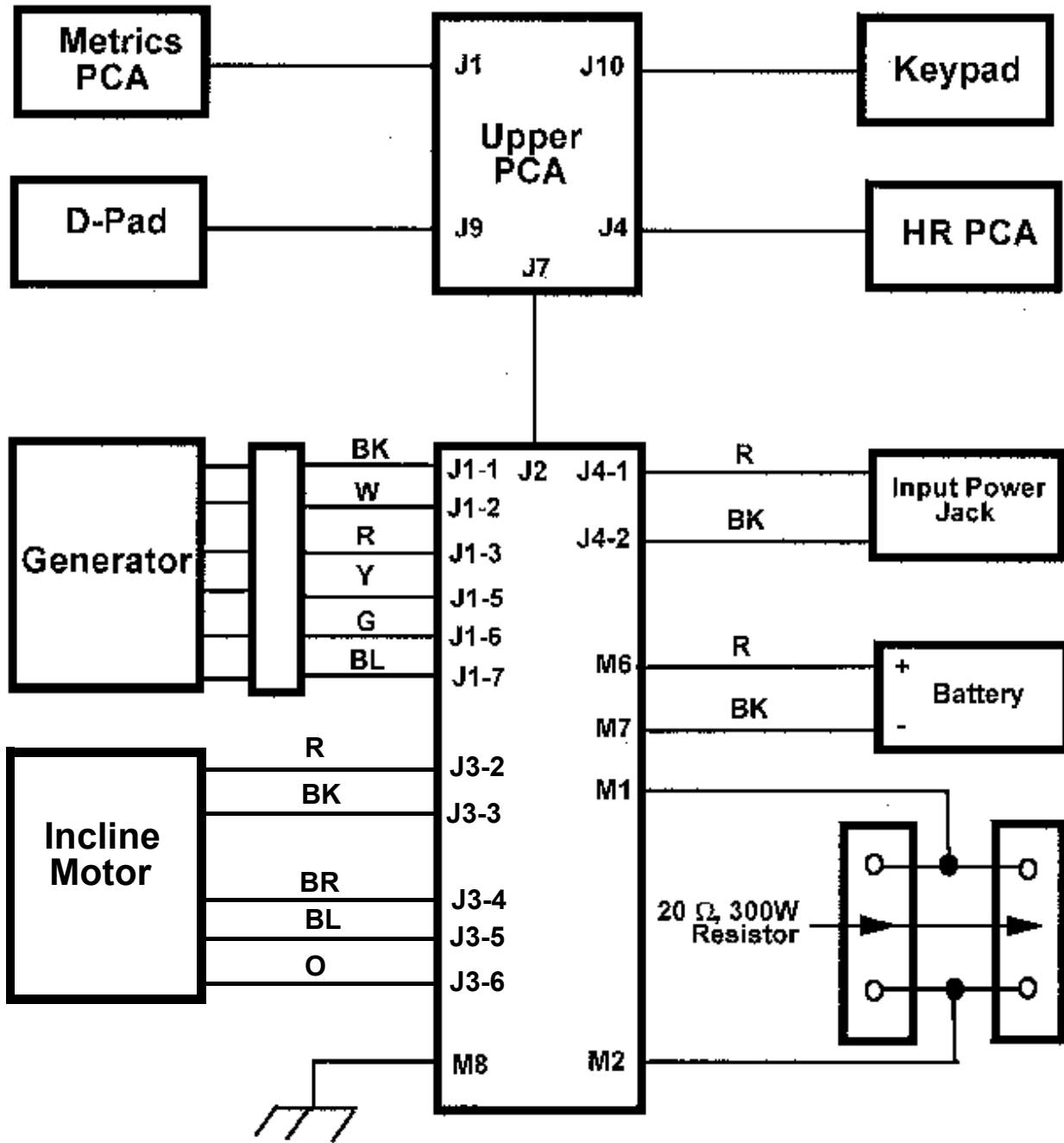

Block Diagram 8.2 - C532i, C556i Navy EFX



C532i, C556i Navy Self Powered EFX

